

CAMBRO®



2013

product catalog

www.cambro.com

2013 Cambro® Catalog Table of Contents



TRAYS

6-28

Personalization	7,17,21
Trays At A Glance	8-9
Camtrays®	10-15
Healthcare Dietary Trays	13
Metric Tray	13
Color Chart	14-15
Camwear® Trays	16
Camlite® Trays	16
Fast Food Trays	17
Market Trays & Pans	18
Non-Skid Versa Camtrays®	19
Non-Skid Versa Camtrays for Room Service	19
Hotel Room Service Trays	20
Camtread® Trays	22
Treadlite™ Trays	23
Polytread® Trays	23
Compartment Trays	24-28
Compartment Serving Trays	26
Trapezoid Compartment Trays	26
Meal Delivery Trays	27
Separator® Compartment Trays	27
Tray On Tray Meal Delivery System	28



TABLE SERVICE

29-44

Dinnerware	30-31
Camcover® Plate Covers	32-33
Pitchers	34
Aliso® Barware	35
Goblets	35
Dessert Glass	35
Tumblers	36-41
CamLid® Kid Lids	37
Camliters®/Decanters	41
6-Gallon Beverage Dispenser	42
Pail with Bail	42
Swirl Bowls	42
Wine Buckets	43
Punch Bowls	43
Bud Vase	43
Personalization	44



DISPLAY

45-55

Deli Crocks & Platters	46
ShowFest® Display Bowls & Trays	47
Serving Bowls	48-50
Display Covers & Trays	51
Crocks	52
Ladles	52
Serving Spoons	53
High Heat Camtensils®	53
Tongs	54
Shakers/Dredges	55
Condiment Jars	55



CAMSHELVING®

56-75

Camshelving®	57-75
Consulting Service	59
Components	60
Space Utilization	61
Configuration Details	62
Post Kits	63
Shelf Kits	64
Starter Units	65-68
Add-On Units	65-68
Mobile Post Kits	69
Mobile Starter Units	70-71
High Density	72-73
Security Cage	74
Divider Bars	74
Tray Slide Rack	74
Wall Shelves & Extenders	75



ELEMENTS SERIES

76-89

Camshelving Elements Series	76-89
Weight Capacity	77
Space Utilization	78
Configuration Details	79
Consulting Service	79
Post Kits	81
Accessories	81
Shelf Kits	82-83
Starter Units	84
Add-on Units	85
Mobile Post Kits	86
Mobile Starter Units	87
Divider Bars	88
Dunnage Racks	89



STORAGE

90-120

Pizza Dough Boxes	91
Quick Guide To Storage Solutions	92-93
Food Storage Containers	94-101
CamSquares®	94-97
Round Storage Containers	98-101
Food Storage Boxes & Lids	102-105
StoreSafe® Labels	106
Camwear® Food Pans & Lids	107-111
H-Pans™	112-115
Translucent Food Pans	116-117
ColdFest®	118
Ingredient Bins	119
Camcrisper®	119
Scoops	120
Measuring Cups	120



MERCHANDISING

121-142

Versa Food Service System	122-125
Food Bars	126-127
CamKiosk® System	128-130
Hand Sink Cart	131
Work Station	131
Equipment Stand	131
Camcruiser® Vending Carts	132-133
Booster Seats	134
Versa Organizers	134
Portable CamBars®	135-141
Ice Caddies	142



INSULATED TRANSPORT

143-171

Insulated Beverage Servers	144-146
Accessories	147
Hydration Station	147
Beverage Service Carts	148
Insulated Food Servers (Non-Electric)	149-161
Single GN Food Pan, Top-Loading Carriers	149-150
Multiple GN Food Pan, Top-Loading Carriers	150
Multiple GN Food Pan, Front-Loading Carriers	151-152
Camdollies® & Accessories	153
Multiple GN Food Pans, Front-loading Carts	154-157
Sheet Pans & Trays, GN Food Pans/Boxes	158-159
Temperature Maintenance Tools	160-161
Insulated Food Servers (Electric)	162-171
Ultra Pan Carrier® & Ultra Camcart® H-Series	162-164
Combo Cart™ Plus	165-167
Camtherm®	168-170
Transporter Capacity Guide	171



HEALTHCARE

172-183

Non-Skid Versa Camtrays®	173
Non-Skid Versa Camtrays® for Room Service	173
Meal Delivery Ware	174-179
Shoreline Meal Delivery System	174, 178-179
Temperature Retention Systems	175-177
Camduction® System	175-176
Camtherm® Plate and Pellet Heater	177
Reusable CamLids®	178
Camrack® Wash and Store Rack	178
Disposable CamLids®	179
Camshelving® Dome Drying and Storage Rack	180
Meal Delivery Carts	181-183



WAREWASHING

184-210

Camrack® 4-in-1 System	185
Glass and Cup Keepers	186-190
Camrack for Flatware/Plates	191-193
Component System	194-195
Personalization	196-197
Camrack Accessories	198
Selecting The Right Camrack	198
Sizing Reference Guide	199-200
Camdollies®	201-202
Utility Trucks	202
Tray & Dish/Silver Cart	203
Adjustable Dish Caddy	204-205
Versa & Poker Chip Caddies	206-207
Adjustable Tray & Dish Cart	206-207
Cambox® Bus Boxes	208
KD Service Cart & KD Utility Cart	209
Service Carts	210

GENERAL INFORMATION

General Terms	5
Icon Directory	5
Warranty	5
Alpha Numeric Listing	213-222
Roto Color Chart	223

PERSONALIZATION

Camtrays®	7
Fast Food Trays	17
Camtread®	21
Table Service/Storage	44
CamKiosk	130
Camcruisers	133
Camracks	209

www.cambro.com

Visit www.cambro.com for a wide variety of information about our products including new product updates, an interactive Camrack Glass to Rack Guide, consultant cut sheets and CAD drawings, care and maintenance product guides and more.

InStock

Cambro's top selling and most frequently used products are InStock. These products are available to ship to Certified Cambro Distributors with their next shipment. Broken cartons are excluded. InStock products are highlighted in gray throughout the Cambro Product Catalog.

The Trademarks of Cambro and product images are the property of Cambro and are subject to the control and ownership of Cambro. Any use thereof is only granted for the promotion and sales of Cambro products and subject to the control of Cambro Manufacturing Company.

the **cambro**[®] story

cambro[®]

When William and Argyle Campbell first opened the doors at Cambro Manufacturing in 1951 their goal was to make a hospital meal tray of the highest quality possible. Named the Camtray[®], it demonstrated that they were as committed to excellence in the food service industry as they were to the quality of their own products. As 2011 marked the company's 60th year of leadership in quality, innovation and customer service, today Cambro serves the world with the industry's most complete selection of products for widely diverse segments of the food service business.

Since 1951, the company has experienced many changes including a greatly expanded product line, new methods of manufacturing and distribution, and an increased emphasis on issues like environmental responsibility. From a single factory in California, Cambro has grown to become an international presence with production facilities and sales offices in the United States, Europe, the Middle East and Asia. But the original guiding vision of the Campbell brothers remains unchanged: to create and provide the most innovative, durable and highest quality products for the food service industry. Now led by William's son Argyle, Cambro is still dedicated to meeting our customers' needs, and equally committed to helping you serve, satisfy and delight your guests.

At the heart of our business philosophy is our willingness to listen, so in a very real way we owe all our success to you, our customer. Our longevity in a very competitive field for 60 years certainly proves the value of that philosophy, and we are proud to have earned the loyalty of customers of all sizes and in all segments of the industry. From hotels to healthcare to caterers, from restaurant chains to educational facilities, we understand the food service business and we design and create our products with the end user foremost in mind. Our

goal is to provide our customers the best possible value on products that are durable, save labor and increase food safety, so you can offer your guests a superior experience while enhancing profitability.

Cambro is uniquely committed to investing in the people and processes that make our products a reality. We're proud that children and grandchildren of some of our first employees are with us today, and of the dedication to quality and service of our entire family worldwide. We continually work on developing new ideas for specific industry segments, and invest in new tooling and leading-edge machinery to bring these products to market. We persistently strive to improve our manufacturing methods to be more efficient in terms of process and materials, to keep costs under control while keeping our planet healthy. And we constantly seek to maintain quality and value despite rising costs of transport and raw materials, the need to reduce environmental impacts, and the demand of end users for total order accuracy and responsive service across a global market.

From once offering a single product, the Camtray, sixty years ago, today Cambro offers a wide range of trays, table service and display items, storage, shelving, merchandising and insulated transport products, as well as innovative warewashing systems and healthcare meal delivery solutions.

The future is certain to bring great changes to our industry. Yet one thing that will remain a constant is Cambro's tradition of continually developing new products that help food service operators save time and money, increase sales, reduce labor and improve service. In the years ahead, guided by the commitment of its founders to innovation, quality, and value, Cambro Manufacturing will still be the leader in serving the food service industry and you, our valued customer.

General Terms

Cambro products may be combined to obtain prepaid freight.

Specifications, features and equipment shown are based upon the latest information available. Cambro Manufacturing Company reserves the right to make changes at any time, without notice, to price, colors, specifications, accessories and materials. For additional information, please contact your authorized Cambro representative.

Freight

Freight is free on shipments totaling \$3,000 net or more, based on a single order for single delivery within the continental U.S.A. Orders for shipments totaling less than \$3,000 are F.O.B. Any items back ordered from a "free freight order" will be forwarded transportation charges paid. Add-ons are not allowed on "free freight order backorders". Customer requested palletized orders will be charged \$7.00 net per pallet.

Return Merchandise Policy

No merchandise may be returned without written authorization. Authorized returns must be shipped freight prepaid. All returned goods must be new and unused, in original packaging and are subject to a minimum 15% repackaging charge plus outbound freight. Returned of goods must be requested within 60 days of invoice. Special or non-standard items are not returnable.

Assessorial Charges

From time to time, motor carriers will charge for services that are beyond the scope of a normal delivery. In the event that this happens, Cambro Mfg. reserves the right to bill the customer for these charges. Services that fall under this program would include:

- Sort & Segregation of product at customer's dock
- Lift-gate required to off load the product from the truck
- Inside delivery requests

These charges are considered to be assessorial charges and are not included in the prepaid freight program.

Broken Cartons

Orders calling for less than standard pack will be charged \$10.00 net per broken case. Broken cartons are not available on any special order items, the assortment pack, custom imprinted ladles, 4 pack booster chairs, disposable lids or on StoreSafe labels.

There is no broken carton charge on Camracks.

Replacement Parts

Visit www.cambro.com for replacement parts information on Cambro products.

Product Accessories

Contents and accessories shown in photos are not included, except where noted.

Cambro Warranty

Cambro offers a 5 year pro-rated warranty against damage or defects found in excess to normal wear and tear on our Camtrays®, Camtread® trays and Dinnerware. Commercial Electrical Equipment models hold a one year warranty. Non-skid Versa Camtrays, Polycarbonate food storage pans, squares, rounds and lids have a 2-year pro-rated warranty. Camshelving® and Camshelving Elements Series have a one year warranty on workmanship and a lifetime limited warranty against rust and corrosion, excluding mobile posts. For all other Cambro products, Cambro warrants to the original buyer a three-year pro-rated warranty unless otherwise noted. If product proves defective during this time, Cambro grants a pro-rated credit of the original price toward replacement product. The warranty applies on all Cambro products only when used under normal foodservice industry conditions.

Icon Directory

Throughout the Cambro catalog, please use the following easy-to-identify icons to help explain Cambro product features or services.



Food Safety Matters

For 60+ years, Cambro foodservice equipment and supplies have earned the trust and loyalty of customers and public health professionals alike because our products are designed with Food Safety in mind. At Cambro, every product design is based upon the core principle of food safety.

Look for the Cambro StoreSafe mark throughout the Cambro catalog to identify Cambro storage and transportation products that help ensure food safety handling.

You can learn more about Cambro's Food Safety initiatives at www.cambro.com/storesafe



New Product



Dishwasher Safe



Stackable



Foam Insulation



Pro-rated Warranty.



Not For Use In Heated Carts.



Listed by NSF International, an independent, not-for-profit organization which certifies products that meet their criteria for sanitation and cleanability.



Personalization Available Non-Food Contact Areas Only.



One carton of product is within the weight and cube requirements to be shipped by parcel carrier.



Many Cambro products may be recycled. For further information, please contact your Cambro representative.



Cambro "Storage Select" BPA-Free (Bisphenol-A Free) products are available for customers who are interested in products deemed BPA-Free. Please contact your sales representative for more information.

Note: Temperature ranges noted throughout this catalog are based on specific test criteria and provide a general guideline. Individual use may vary due to differences in loading temperatures or ambient temperature.

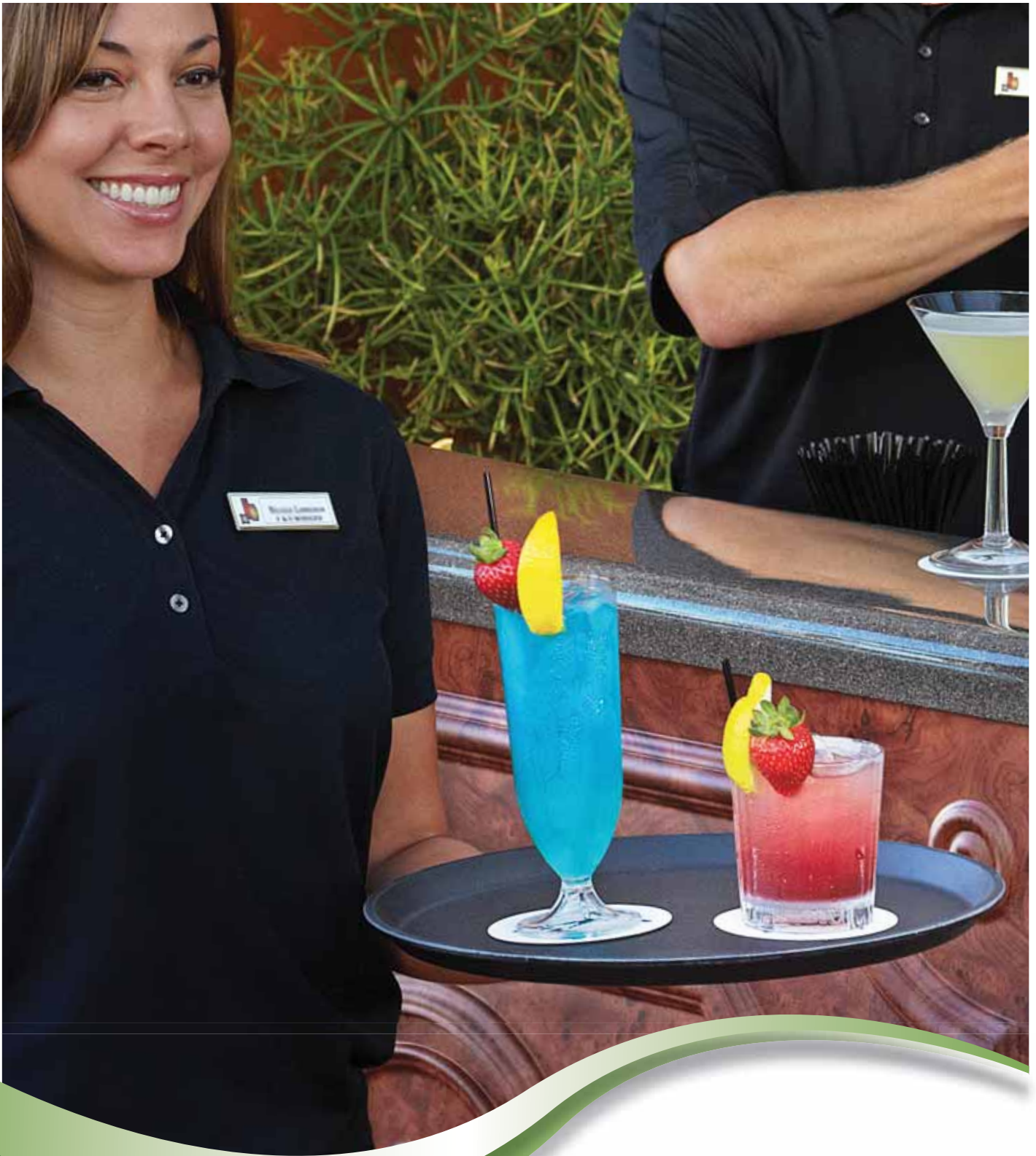

TRAYS

Promote Your Brand – Personalized Camtrays® Trays

Personalize Camtrays Trays to display a message with every tray served. Advertise a product, promote your business, enhance patient satisfaction or strengthen school spirit.



Look for this icon that identifies items that can be personalized.

CAMTRAYS

Digital Printing Process:

Allows printing of multiple color artwork as well as photo reproduction. This process can only be used on light color trays.

Printable Area:

The artwork can cover the flat surface of tray up to 1" from the internal tray edge.

Tray Order Minimum: 72

Silkscreen Printing Process:

Allows printing of artwork with one or multiple colors laying next to each other. This process is best used with light color artwork on dark color trays.

Printable Area:

The artwork can cover the total surface of the tray from one edge to the other.

Tray Order Minimum: 144

Personalization Charges Per Tray:

QUANTITY EACH	ADDITIONAL NET CHARGES
72-144	\$ 0.75
145-288	0.50
289-432	0.25
433 and up	Free

DIGITAL



SILKSCREEN



HOW TO ORDER A SAMPLE

1. Request a Sample

Contact your local Cambro representative to complete and submit the sample request form to Cambro.

2. Provide Artwork

Provide ready to use artwork, digital format only. Sample request form must be submitted to Cambro PRIOR to artwork being sent. If artwork is incomplete, graphic support services are available for \$50.00 per hour.

3. Submit Artwork

E-mail artwork to Cambro Rep or to Cambro at letsgetpersonal@Cambro.com. Title e-mail subject with logo name and provide contact info.

File dimensions: 100% reproduction size, 300 dpi resolution.

File type:

Adobe® Illustrator®, Photoshop®.

File format: jpeg, tiff, and eps.

Or mail artwork on a CD-ROM to: Cambro Attn: Kristie Patterson, 7601 Clay Avenue, Huntington Beach, CA 92648.

4. Questions

Contact Kristie Patterson at 714-230-4125 direct or 800-854-7631 ext. 4125.

5. Sample Approval

A signed sample approval form must be faxed to Cambro customer service prior to processing any purchase orders. This form is included with each sample.

6. Sample Turnaround

7-10 business days.

* All personalized tray orders are full case quantities only; no broken cartons.

7. Personalization Charges (NET)

Tray Sample:

\$ 50.00 (Charge will be billed on sample order, credited on first purchase order.)

Trays At A Glance

Patron Trays

Camtray®

The industry standard. Durable fiberglass construction backed by a 5 year prorated warranty against breakage.

43 SIZES	7 SHAPES	55 COLORS
-------------	-------------	--------------



Non-Slip Service Trays

Camtread® Trays

Durable fiberglass construction with non-skid surface. Grips service items to avoid spills.

17 SIZES	3 SHAPES	2 COLORS
-------------	-------------	-------------



Camlite® Tray

Combine economy with durability. Fiberglass construction.

6 SIZES	1 SHAPE	9 COLORS
------------	------------	-------------



Treadlite™ Tray

Fiberglass reinforced polyester lightweight tray with molded in non-skid surface ensures items stay in place during service.

2 SIZES	1 SHAPE	2 COLORS
------------	------------	-------------



Camwear® Trays

Made from virtually unbreakable Camwear polycarbonate.

3 SIZES	2 SHAPES	2 COLORS
------------	-------------	-------------



Polytread® Trays

General purpose tray with non-skid surface.

6 SIZES	2 SHAPES	2 COLORS
------------	-------------	-------------



Fast Food Tray

Economical choice that withstands frequent use.

3 SIZES	1 SHAPE	14 COLORS
------------	------------	--------------



Non-Skid Versa Camtrays

Non-Skid Versa Trays reduce waste, save money and provide a stable tray surface for meal delivery.

3 SIZES	3 SHAPES	3 COLORS
------------	-------------	-------------



Healthcare Dietary Tray

Low profile offers patient comfort. Made of durable fiberglass. Camtray and Non-Skid Versa Camtrays are also recommended for patient meal delivery.

8 SIZES	1 SHAPE	58 COLORS
------------	------------	--------------



Service Trays

Hotel Room Service Tray

Lightweight yet durable service tray features a contemporary design.



1	1	3
SIZE	SHAPE	COLORS



Trapezoid Compartment Tray

Offers seven deep compartments for ample, portion controlled serving.



1	1	1
SIZE	SHAPE	COLOR



Display Trays

Market Trays

Ideal for merchandising food items in showcases. Durable fiberglass construction.

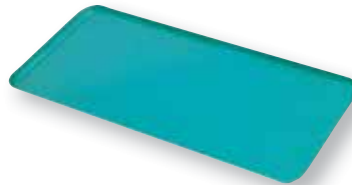

19	1	6
SIZES	SHAPE	COLORS



Separator® Compartment Trays

Tray with cover separates each compartment to retain food temperature and reduce spills.



2	1	4
SIZES	SHAPE	COLORS



Tray on Tray Meal Delivery System

Use Insert Tray and Base Tray to serve hot and cold foods together.



3	2	5
SIZES	SHAPES	COLORS



Compartment Trays

Compartment Tray

Six compartment tray available in three materials.



1	1	19
SIZE	SHAPE	COLORS



Meal Delivery Trays

Deep compartments and snap-on cover.

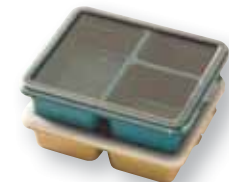

2	2	4
SIZES	SHAPES	COLORS



2 x 2 Compartment Trays

Durable trays with easy grip handles. Trays fit side by side in dishrack to reduce warewashing expense.



2	2	13
SIZES	SHAPES	COLORS



Compartment Serving Trays

Compartment configurations to meet all menu requirements.



2	3	8
SIZES	SHAPES	COLORS





Class of 1966

Nothing withstands the test of time like a Cambro® Camtray®. Designed to outlast just about everything and everyone, Camtrays are backed by a 5 year prorated warranty against cracking, warping or breakage. Durable fiberglass construction ensures that Camtrays will perform in the most demanding environments and last for decades. Available in the widest selection of sizes, shapes and colors. Camtrays can be personalized with digital quality images featuring your logo or design.



Eight stacking lugs ensure straight stacking. Dri-Stak separators allow for quick drying.



Permanent decorations. All patterns and decorations are molded under tough surface mat and resin to last.



Top fiberglass layer is smooth and strong. Coupled with polyester resin, it resists impact, stains and chemicals.

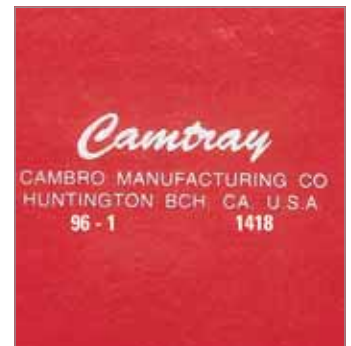

Each tray is dated on the bottom (production year and quarter), demonstrating how long it lasts.

Camtray®

- Use in restaurants, hotel room service, cafeterias, food courts, hospitals and schools.
- Durable construction backed by five year prorated warranty against breakage.
- Made of lightweight, high-impact fiberglass with reinforced edges.

- Stain, odor and scratch resistant.
- Molded-in Dri-Stak separators ensure even air flow between trays for quick drying.
- Stacking lugs keep trays stacked in place.



Rectangular Camtrays

The industry standard.

Available in Group I colors and patterns and Group III Wood.

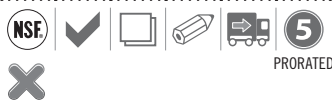

Trapezoid Camtrays

Saves tabletop space and increases seating capacity.

Available in Group I colors and patterns and Group III Wood.

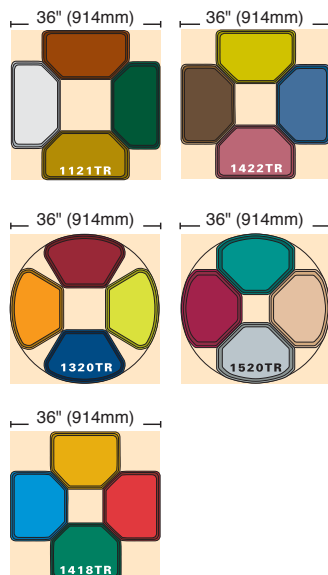

CODE	DIMENSIONS	CASE PACK	CASE LBS. (CUBE)	LIST PRICE EA.	
				GROUP I	GROUP III
Rectangular					
46	4¼" x 6"	12	1.86 (0.07)	\$ 4.85	\$ 6.75
57*	4 ¹⁵ / ₁₆ " x 6 ¹⁵ / ₁₆ "	12	1.97 (0.07)	5.25	7.35
810	8" x 9 ⁷ / ₈ "	12	6.46 (0.22)	11.55	14.95
915	8 ³ / ₄ " x 15"	12	10.16 (0.39)	16.45	19.05
926*	8 ⁷ / ₈ " x 25 ³ / ₁₆ " x 1"	12	17.74 (0.76)	21.50	27.80
1014	10 ⁷ / ₈ " x 13 ³ / ₄ "	12	10.43 (0.42)	15.25	19.70
1216	12" x 16 ³ / ₁₆ "	12	13.01 (0.59)	17.60	23.10
1318*	12 ⁵ / ₈ " x 17 ³ / ₄ " x 1 ¹ / ₁₆ "	12	17.48 (0.75)	21.85	27.30
1418	14" x 18"	12	19.52 (0.75)	21.05	27.45
1520	15" x 20 ¹ / ₄ "	12	21.22 (0.80)	25.45	33.00
1622	16" x 22"	12	28.54 (1.02)	29.30	38.10
16225*	16 ¹ / ₂ " x 22 ¹ / ₂ "	12	30.40 (1.09)	32.10	40.10
1826	17 ⁵ / ₈ " x 25 ³ / ₄ "	6	16.7 (1.91)	39.05	50.25
2025*	20 ¹ / ₄ " x 25 ³ / ₁₆ "	6	21.39 (0.71)	47.60	57.95
Trapezoid					
1418TR	14" x 18"	12	14.41 (0.63)	19.95	26.95
1422TR*	14" x 22"	12	17.14 (0.84)	21.85	29.55
1520TR*	14 ³ / ₁₆ " x 19 ¹ / ₂ "	12	16.4 (0.66)	23.30	30.45

InStock Colors: Antique Parchment (101), Black (110). * Special order item not carried in stock, non-returnable. One case order minimum.

Camtray®

Oval Camtrays

Perfect for banquet service.

Available in Group I colors and patterns except Doily and Group III patterns.

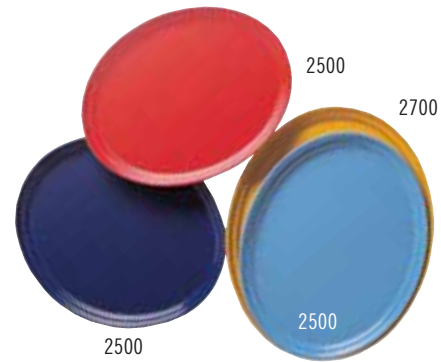

Round Camtrays

A favorite for pizza and beverage service.

Available in Group I colors and patterns except Doily and Group III patterns.

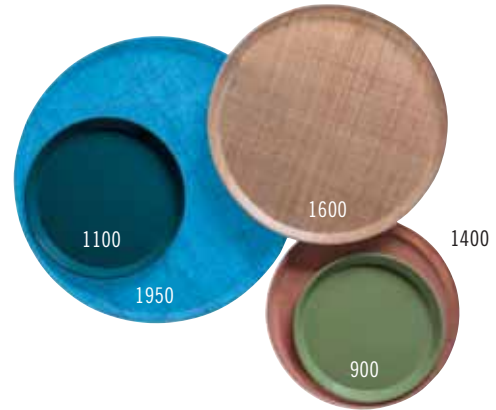
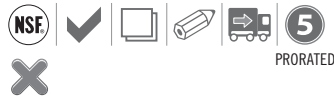

Insert Camtrays

Fits onto a Camtray to separate hot and cold food, ideal for dietary tray service.

Available in Group I colors and patterns except Doily.

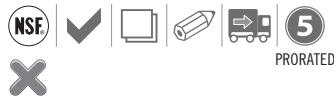

CODE	DIMENSIONS	CASE PACK	CASE LBS. (CUBE)	LIST PRICE EA.	
				GROUP I	GROUP III
Oval					
2500*	19¼" x 24"	6	15.67 (0.87)	\$ 38.05	\$ 50.25
2700*	22" x 26⅞"	6	18.75 (0.72)	44.35	58.70
Round					
900*	9"	12	4.43 (0.21)	11.70	14.85
1000*	10"	12	6.19 (0.26)	12.95	16.80
1100	11"	12	7.25 (0.34)	12.95	16.40
1200*	12"	12	8.24 (0.33)	14.30	19.15
1300*	13"	12	9.42 (0.44)	15.75	20.80
1400	14"	12	13.94 (0.51)	16.05	21.75
1550*	16" <i>low profile</i>	12	16.36 (0.70)	20.50	26.75
1600	16"	12	15.40 (0.73)	20.15	26.95
1950*	19½" <i>low profile</i>	12	25.26 (1.04)	27.80	36.65
Insert					
1015* (2 trays fit into a 1520)	10⅞" x 15"	24	22.89 (0.85)	15.75	20.40
1116* (2 trays fit into a 1622)	10⅞" x 15⅞"	24	24.50 (1.07)	16.50	23.10

* Special order item not carried in stock non-returnable.

Dietary Trays and Metric Camtrays®

Healthcare Dietary Trays

- Designed specifically for in-room patient feeding.
- Low slope edge provides easy access when dining from a hospital bed.
- Made of lightweight fiberglass with reinforced edges.

Available in Group I colors and patterns and Group III Wood.

Dietary trays are guaranteed for one year against breakage.



CODE	DIMENSIONS	CASE PACK	CASE LBS. (CUBE)	LIST PRICE EA.	
				GROUP I	GROUP III
Dietary					
1216D*	12" x 16"	12	14.02 (0.47)	\$ 18.20	\$ 24.15
1219D*	12" x 19"	12	17.42 (0.64)	21.40	27.60
1220D*	12" x 20"	12	16.45 (0.65)	23.15	29.70
1222D*	12" x 22"	12	20 (0.71)	23.15	29.65
1418D*	14" x 18"	12	16.56 (0.65)	21.20	28.00
1520D*	15" x 20 ¹ / ₁₆ "	12	10.76 (0.78)	25.20	31.85
1622D*	15 ⁷ / ₈ " x 21 ¹ / ₈ "	12	26 (1.02)	28.90	37.75

* Special order item not carried in stock, non-returnable.

Metric Camtrays

Designed to meet international specifications.

Available in Group I colors and patterns and Group III Wood. 3555TR is available in Group I colors and patterns except Doily.

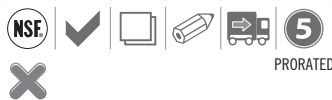

CODE	DIMENSIONS	CASE PACK	CASE LBS. (CUBE)	LIST PRICE EA.	
				GROUP I	GROUP III
Metric					
1313*	13" x 13" (33 x 33 cm)	12	13.8 (0.43)	\$ 15.75	\$ 20.65
2632*	10 ⁷ / ₁₆ " x 12 ³ / ₄ " (26,5 x 32,5 cm)	12	10 (0.35)	14.90	19.25
3046*	11 ¹³ / ₁₆ " x 18 ¹ / ₈ " (30 x 46 cm)	12	17.5 (0.57)	18.70	24.80
3242*	12 ¹ / ₂ " x 16 ¹ / ₂ " (31,9 x 41,9 cm)	12	7.2 (0.50)	18.05	20.80
3253*	12 ³ / ₄ " x 20 ⁷ / ₈ " (32,5 x 53 cm)	12	17.04 (0.66)	22.20	29.70
3343*	13" x 17" (33 x 43 cm)	12	15.51 (0.50)	18.75	24.95
3753*	14 ¹ / ₁₆ " x 20 ⁷ / ₈ " (37 x 53 cm)	12	22.96 (0.86)	25.30	33.05
3853*	14 ³ / ₄ " x 20 ⁷ / ₈ " (37,5 x 53 cm)	12	22 (0.81)	25.10	33.05

* Special order item not carried in stock, non-returnable.

Camtray® Group I Colors

Colors listed alphabetically. See numerical reference on following page.

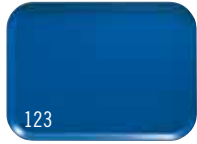

123
Amazon Blue



101
Antique Parchment



513
Bay Leaf Brown



110
Black



409
Blush



116
Brazil Brown



522
Burgundy Wine



521
Cambro Red



537
Cameo Yellow

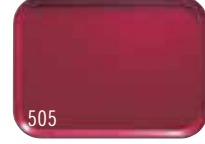

505
Cherry Red



220
Citrus Orange



538
Cottage White



117
Dark Peach



104
Desert Tan



514
Earthen Gold



221
Ever Red



551
Grape



105
Horizon Blue



429
Key Lime



536
Lemon Chiffon



106
Light Peach



113
Lime-ade



504
Mustard



428
Olive Green



222
Orange Pizzazz



107
Pearl Gray



410
Raspberry Cream



501
Real Rust



518
Robin Egg Blue



119
Sherwood Green



510
Signal Red



177
Sky Blue



401
Slate Blue



508
Suede Brown



199
Taupe



414
Teal



171
Tuscan Gold



148
White

Due to the catalog printing process, the colors & patterns shown may not be exact.
Contact Cambro or a Cambro representative for a color chip.

Camtray® Group I Patterns

Galaxy

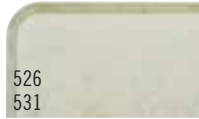

526
531
Antique Parchment
(526 Gold), (531 Silver)

Swirl



270
Black & Gold **NR**



277
Gray **NR**

Doily



241
Antique Parchment **NR**

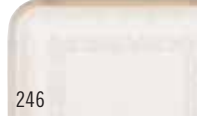

246
Light Peach **NR**

Decorator



203
Grass Mat **NR**

Abstract

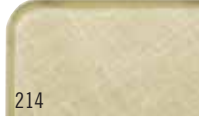

214
Tan **NR**

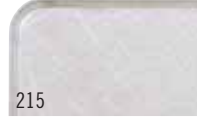

215
Gray **NR**

NR Trays are non-returnable.



Camtray Group III Wood

Wood



308
Burma Teak **NR**



304
Country Oak **NR**



301
Dark Basketweave **NR**



309
Java Teak **NR**

Linen



329
Toffee **NR**



302
Light Basketweave **NR**



303
Light Butcher Block **NR**



307
Light Elm **NR**



204
Rattan **NR**

NR Trays are non-returnable.

Camtray Group I Colors – Numerical Reference by Color Code

Antique Parchment (101),
Desert Tan (104), Horizon Blue (105),
Light Peach (106), Pearl Gray (107),
Black (110), Lime-ade (113),
Brazil Brown (116), Dark Peach (117),

Sherwood Green (119),
Amazon Blue (123), White (148),
Tuscan Gold (171), Sky Blue (177),
Taupe (199), Citrus Orange (220),
Ever Red (221), Orange Pizzazz (222),

Slate Blue (401), Blush (409),
Raspberry Cream (410), Teal (414),
Olive Green (428), Key Lime (429),
Real Rust (501), Mustard (504),
Cherry Red (505), Suede Brown (508),

Signal Red (510), Bayleaf Brown (513),
Earthen Gold (514), Robin Egg Blue (518),
Cambro Red (521), Burgundy Wine (522),
Lemon Chiffon (536), Cameo Yellow (537),
Cottage White (538), Grape (551).

Due to the catalog printing process, the colors & patterns shown may not be exact.
Contact Cambro or a Cambro representative for a color chip.

Camwear® Polycarbonate & Camlite® Trays

Camwear Trays

- Ideal for use in correctional facilities.
- Made from virtually unbreakable polycarbonate.
- Large stacking lugs keep trays straight and in place when stacked.
- Molded-in Dri-Stak separators allow air flow between trays for quick drying.

Colors: Blue (168), Beige (133).



Camlite Tray

- An economical, all-purpose tray for self-serve food service dining.
- Made of fiberglass with reinforced corners.
- Stacking lugs keep trays straight.
- Molded-in Dri-Stak separators allow air circulation for quick drying.
- Camlite Trays cannot be personalized.

Colors: Rose Red (163), Yellow (145), Green (162), Blue (142), Tan (161), Steel White (676), Steel Red (675), Steel Blue (674), Black (110).

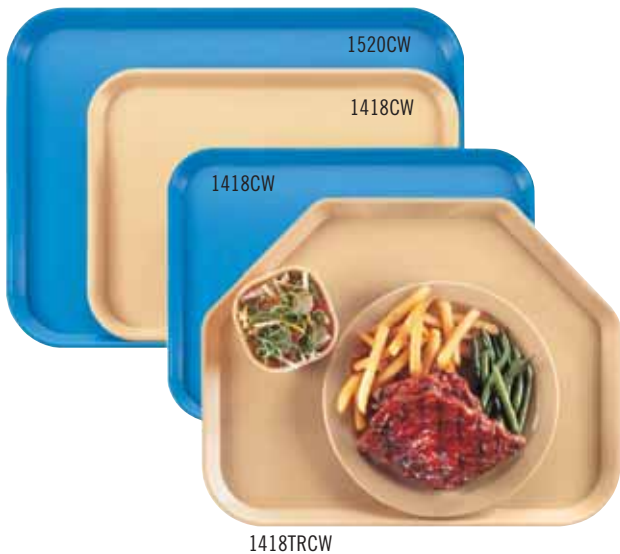

CODE	DIMENSIONS	CASE PACK	CASE LBS. (CUBE)	LIST PRICE EA.
Rectangular				
1418CW	13 ¹⁵ / ₁₆ " x 17 ¹⁵ / ₁₆ "	12	17.43 (0.67)	\$ 24.95
1520CW	14 ⁷ / ₈ " x 20 ⁷ / ₈ "	12	20.50 (0.87)	25.95
Trapezoid				
1418TRCW	14" x 18"	12	16 (0.72)	24.95

CODE	DIMENSIONS	CASE PACK	CASE LBS. (CUBE)	LIST PRICE EA.
Rectangular				
1014CL	10 ⁵ / ₈ " x 13 ³ / ₄ "	12	11.15 (0.40)	\$ 13.85
1216CL	12" x 16 ⁵ / ₁₆ "	12	12.92 (0.57)	15.70
1418CL	14" x 18"	12	17.59 (0.67)	17.10
1520CL	15" x 20 ¹ / ₄ "	12	22.06 (0.82)	19.55
1826CL	17 ⁷ / ₈ " x 25 ³ / ₄ "	12	32.06 (1.34)	28.10
3253CL	12 ³ / ₄ " x 20 ⁷ / ₈ "	12	18.87 (0.67)	16.85

Fast Food Tray

- Perfect for self-serve or quick-serve dining.
- Made of durable polypropylene.
- Attractive textured surface hides scratches.



CODE	DIMENSIONS	CASE PACK	CASE LBS. (CUBE)	LIST PRICE EA.
1014FF	10 ⁷ / ₁₆ " x 13 ⁹ / ₁₆ "	24	13.02 (0.61)	\$ 4.30
1216FF	11 ⁷ / ₈ " x 16 ⁷ / ₈ "	24	18.84 (1.01)	5.10
1418FF	13 ³ / ₁₆ " x 17 ³ / ₄ "	12	13.50 (0.63)	6.55

InStock Colors: Black (110), Red (163).



Promote Your Brand – Fast Food Trays

Personalized Fast Food Trays display a message with every tray served. Advertise products, promote your business and brand or strengthen school spirit.

Available Colors:



How To Order A Sample

1. Request a Sample

Contact your local Cambro rep to complete and submit the sample request form to Cambro. Specify location of imprint on tray. Maximum imprint size: 6" x 6".

2. Provide Artwork

Provide ready to use artwork, digital format only. Sample request form must be submitted to Cambro **PRIOR** to artwork being sent. If artwork is incomplete, graphic support services will be offered for \$ 50.00 per hour.

3. Submit Artwork

E-mail artwork to your Cambro Rep or the Cambro Personalization Dept. at letsgetpersonal@cambro.com. Title e-mail subject with logo name and provide contact info. **File dimensions:** 100% reproduction size, 300dpi resolution. **File type:** Adobe® Illustrator®, Photoshop®. **File format:** jpeg, tiff, and eps. Or mail artwork on a CD-ROM to: Cambro Manufacturing Company Attn: Kristie Patterson, Cambro, Personalization Dept., 7601 Clay Avenue, Huntington Beach, CA 92648.

4. Questions

Call Kristie Patterson at 714-230-4125 direct or 800-854-7631 ext. 4125.

5. Sample Approval

Signed approval form must be faxed to Cambro customer service prior to processing any purchase orders. Approval form included with each sample tray.

Personalization Charges (Net)

Tray Sample

\$50.00 (Charge will be billed on sample order, credited on first purchase order)

Custom Die Charge

\$75.00 (Billed on sample order, one time charge)

TRAY QUANTITY	COST PER TRAY
288-767	\$ 0.36
768-1199	0.27
1200-5999	0.18
6000-11,999	0.14
12,000 +	0.12

Market Trays & Pans

Market Trays and Pans

- Attractively merchandise desserts, pastries, hors d'oeuvres and salads.
- Ideal for use in bakeries, supermarkets and delis.
- High-impact resistant fiberglass with reinforced edges provide strength.
- Trays and pans resist odors and will not oxidize like aluminum trays.
- Pans feature a 2" (5 cm) rim for salads and ready to eat foods.

Colors: Salmon (149)*, Yellow (145)*, Blue (142), Green (140), White (148), Black (110).



*These colors are not NSF listed.



Market Trays make appealing bakery merchandising quick and easy.



Market Pans showcase deli items.

CODE	DIMENSIONS W x L x H	CASE PACK	CASE LBS. (CUBE)	LIST PRICE EA.
Market Trays				
630MT*	6 ⁷ / ₁₆ " x 30" x 3/4"	12	14.54 (0.57)	\$ 19.60
826MT*	8 ³ / ₄ " x 25 ¹ / ₂ " x 3/4"	12	16.48 (0.52)	16.05
830MT*	8 ⁷ / ₁₆ " x 30" x 3/4"	12	20.50 (0.75)	22.15
913MT*	8 ⁷ / ₈ " x 12 ³ / ₄ " x 1"	12	10.22 (0.40)	17.15
918MT*	8 ¹¹ / ₁₆ " x 18" x 1 ¹³ / ₁₆ "	12	10.22 (0.40)	18.60
926MT*	8 ⁷ / ₈ " x 25 ⁹ / ₁₆ " x 1"	12	16.42 (0.79)	20.70
1015MT*	10 ¹ / ₈ " x 15" x 3/4"	24	13.75 (0.85)	15.50
1030MT*	10 ¹ / ₁₆ " x 30" x 3/4"	12	22.50 (0.83)	24.50
1218MT*	11 ¹ / ₂ " x 17 ³ / ₄ " x 1"	12	15.50 (0.63)	19.35
1224MT*	12 ¹ / ₁₆ " x 24" x 3/4"	12	21.38 (0.82)	24.25
1230MT*	12 ¹ / ₁₆ " x 30" x 3/4"	12	25.13 (0.96)	28.15
1318MT*	12 ⁹ / ₁₆ " x 17 ³ / ₄ " x 1 ¹¹ / ₁₆ "	12	17.56 (0.76)	19.85
1826MT*	17 ¹³ / ₁₆ " x 25 ¹¹ / ₁₆ " x 1 ¹ / ₁₆ "	6	16.58 (0.88)	31.65
2025MT*	20 ³ / ₄ " x 25 ⁹ / ₁₆ " x 1 ¹³ / ₁₆ "	6	21 (0.80)	41.45
Market Pans				
6302MT*	6 ⁹ / ₁₆ " x 30" x 2"	12	17.52 (0.72)	30.75
8262MT*	8 ³ / ₈ " x 25 ¹ / ₂ " x 2"	12	21 (0.93)	25.20
8302MT*	8 ⁷ / ₁₆ " x 30" x 2"	12	23.69 (0.90)	33.85
92615MT*	8 ⁷ / ₈ " x 25 ¹ / ₂ " x 1 ¹ / ₂ "	12	19.65 (0.72)	20.65
10302MT*	10 ¹ / ₁₆ " x 30" x 2"	12	28 (1.15)	36.20

* Special order item not carried in stock, non-returnable. One case order minimum.



Non-Skid Versa Camtrays®

- Non-Skid Trays reduce waste, save money and provide a stable tray surface for meal delivery.
- Switching from paper tray mats or liners will generate annual savings of over 50%.
- Non-Skid Camtrays provide a better grip for safer meal delivery.
- Dishwasher safe in low and high temperatures.
- Stacking lugs allow for quick drying.

Colors: Black with Pebbled Black (382), Pearl Gray with Titan (381), Ivory with Sahara (380).



Personalization available. Visit www.cambro.com for details.



Non-skid trays grip table top items firmly.

CODE	DESCRIPTION	DIMENSIONS	CASE LBS. (CUBE)	LIST PRICE EA.
1418VC	Non-Skid Versa Camtray	14" x 18"	20.74 (0.69)	\$ 37.40
1520VC	Non-Skid Versa Camtray	15" x 20"	26.05 (0.61)	41.80
1622VC*	Non-Skid Versa Camtray	16" x 22"	31.8 (1.11)	51.70
1418VDC	Non-Skid Versa Dietary Tray	14" x 18"	20.45 (0.75)	37.40
1520VDC	Non-Skid Versa Dietary Tray	15" x 20"	26.9 (0.74)	41.80

Case Pack: 12

InStock Colors: Black with Pebbled Black (382), Pearl Gray with Titan (381), Ivory with Sahara (380).

*1622VC only available in Ivory with Sahara (380).

Non-Skid Versa Camtrays for Room Service

- Ergonomic handles allow for safe and elegant meal delivery.
- Trays fit within existing meal delivery carts, that accommodate 15" x 20" trays.
- Non-skid surface eliminates the need for tray mats, saving time and money.
- Dishwasher safe at high and low temperatures.
- Stacking lugs allow for quick drying.

Colors: Black with Pebbled Black (382), Pearl Gray with Titan (381), Ivory with Sahara (380).



Personalization available. Visit www.cambro.com for details.

CODE	DESCRIPTION	DIMENSIONS	CASE LBS. (CUBE)	LIST PRICE EA.
1520VCRST	Room Service Non-Skid Camtray	15" x 20"	22.5 (0.88)	\$ 44.00

Case Pack: 12

InStock Colors: Black with Pebbled Black (382), Pearl Gray with Titan (381), Ivory with Sahara (380).

1.800.833.3003



Black with Pebbled Black (382)

Pearl Gray with Titan (381)

Ivory with Sahara (380)



Hotel Room Service Tray

- Lightweight, weighs up to 30% less than wood room service trays.
- Dishwasher safe once a day, easily wipes clean. Saves time and labor.
- Standard 14" x 19" tray mat can be used on the surface of the tray.

Colors: Brushed Steel (612), Venge (384), Walnut (376).



Brushed Steel (612)

Venge (384)

Walnut (376)

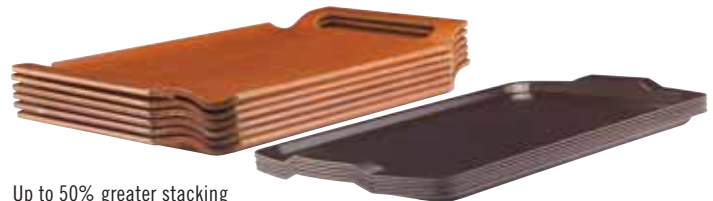

Up to 50% greater stacking capacity than comparable wood trays.

CODE	OUTER DIMENSION	INNER DIMENSION	CASE LBS. (CUBE)	LIST PRICE EA.
1525RST	15½" x 25"	14" x 21"	29 (0.71)	\$ 30.85

Case Pack: 12

Promote Your Brand – Personalized Camtread® Trays

Personalize Camtread Trays to display a message with every tray served. Advertise a product, promote your business, enhance patient satisfaction or strengthen school spirit.

 Look for this icon that identifies items that can be personalized.

Camtread Trays

Tray Back Personalization Digital Printing Process:

Allows printing of multiple color artwork as well as photo reproduction.

Printable Area:

The artwork can cover the flat surface of tray up to 1" from the external tray edge.

Tray Order Minimum: 72

Tray Back Personalization Charges Per Tray:

QUANTITY EACH	ADDITIONAL NET CHARGES
72-144	\$ 0.75
145-288	0.50
289-432	0.25
433 and up	Free

White trays are recommended for tray back personalization.

Rubber Surface Embossing Electronic File Format:

Adobe Illustrator EPS formats.

Embossing Process Printable Area:

The artwork can cover the surface of the tray up to 1" from the internal tray edge.

Embossing Personalization Charge Per Tray:

QUANTITY EACH	ADDITIONAL NET CHARGES
72 and up	\$ 1.00

Tray Order Minimum: 72

TRAY BACK
PERSONALIZATION



EMBOSSING



How To Order A Sample

1. Request a Sample

Contact your local Cambro representative to complete and submit the sample request form to Cambro.

2. Provide Artwork

Provide ready to use artwork, digital format only. Sample request form must be submitted to Cambro PRIOR to artwork being sent. If artwork is incomplete, graphic support services are available for \$50.00 per hour.

3. Submit Artwork

E-mail artwork to Cambro Rep or to Cambro at letsgetpersonal@cambro.com. Title e-mail subject with logo name and provide contact info. **File dimensions:** 100% reproduction size, 300 dpi resolution. **File type:** Adobe® Illustrator®, Photoshop®. **File format:** jpeg, tiff, and eps. Or mail artwork on a CD-ROM to: Cambro Attn: Kristie Patterson, 7601 Clay Avenue, Huntington Beach, CA 92648.

4. Questions

Contact Kristie Patterson at 714-230-4125 direct or 800-854-7631 ext. 4125.

5. Sample Approval

A signed sample approval form must be faxed to Cambro customer service prior to processing any purchase orders. This form is included with each sample.

6. Sample Turnaround

7-10 business days.
* All personalized tray orders are full case quantities only; no broken cartons.

7. Personalization Charges (NET)

Tray Sample:

\$ 50.00 (Charge will be billed on sample order, credited on first purchase order.)

Camtread® Trays

- An industry standard for caterers, hotels, banquet halls, dining rooms and bars.
- Non-skid surface ensures drinks and meals stay in place during transport.
- Made of heavy-duty, durable fiberglass with a thick molded in, non-skid surface.

Orders for non-standard Camtread Tray colors will be handled by special quotation only.

* Special order item not carried in stock, non-returnable. One case order minimum.

Do not use Camtread Trays in enclosed heated carts.



Non-skid, non-slip trays. Less breakage, greater profits.



Tray Colors:



5 FIVE YEAR PRORATED WARRANTY AGAINST DELAMINATION



CODE	DIMENSIONS	CASE PACK	CASE LBS. (CUBE)	LIST PRICE EA.
Round				
900CT*	9"	12	5.79 (0.22)	\$ 18.75
1100CT	11"	12	8.95 (0.32)	18.75
1400CT	14"	12	14 (0.52)	24.95
1550CT*	16" <i>low profile</i>	12	18.48 (0.70)	33.90
1600CT	16"	12	25.75 (0.68)	32.90
1800CT	18"	6	12.6 (0.52)	46.65
1950CT*	19 ⁷ / ₁₆ " <i>low profile</i>	12	30.15 (1.05)	47.75
Oval				
2500CT	19 ³ / ₄ " x 23 ³ / ₈ "	6	18.76 (0.84)	59.40
2700CT	22" x 26 ⁵ / ₈ "	6	24.50 (1.33)	66.85
2900CT	28 ⁵ / ₈ " x 23 ¹ / ₂ "	6	28.57 (0.91)	75.85
Rectangular				
1014CT*	10 ⁵ / ₈ " x 13 ³ / ₄ "	12	13.76 (0.42)	23.10
1216CT*	12" x 16 ⁵ / ₁₆ "	12	17.78 (0.59)	26.70
1418CT	14" x 18"	12	22.01 (0.68)	33.25
1520CT*	15" x 20 ¹ / ₄ "	12	19.48 (0.7)	37.80
1622CT*	16" x 22"	12	39.46 (1.01)	46.65
1826CT	17 ¹³ / ₁₆ " x 25 ¹ / ₁₆ "	6	23.33 (0.91)	56.00
3253CT*	12 ³ / ₄ " x 20 ⁷ / ₈ "	12	27.10 (0.75)	38.90

InStock Colors: Black Satin (110), Tavern Tan (138).

Treadlite™ Tray

- Fiberglass reinforced polyester lightweight tray has a molded in non-skid surface.
- Non-skid surface ensures items stay in place during service.
- Reinforced edges provide superior strength and protection.
- Stacking lugs enhance air circulation for quick, effective drying and perfect stacking.



CODE	DIAMETER	CASE LBS. (CUBE)	LIST PRICE EA.
1400TL	14"	10.55 (0.52)	\$ 15.00
1600TL	16"	15.98 (0.69)	20.00

Case Pack: 12 InStock Colors: Black Satin (110), Tavern Tan (138).

Tray Colors:

110
Black Satin

138
Tavern Tan

Polytread® Trays

- An economical service tray for restaurants, bars and banquet service.
- General, all-purpose, non-skid service trays help reduce spills and breakage.
- Non-skid surface is bonded directly into a lightweight polypropylene tray.
- Dri-Stak separators allow air to circulate freely over and under each tray for fast drying.



CODE	DIMENSIONS	CASE PACK	CASE LBS. (CUBE)	LIST PRICE EA.
Round				
PT1100	11"	12	6.75 (0.31)	\$ 10.25
PT1400	14"	12	10.44 (0.53)	13.70
PT1600	16"	12	12.88 (0.66)	18.50
Rectangular				
PT1014	10 ¹⁵ / ₁₆ " x 13 ⁵ / ₈ "	24	19.50 (0.76)	13.15
PT1216	11 ⁷ / ₈ " x 16 ¹ / ₄ "	24	25.25 (1.11)	14.35
PT1418	14" x 18"	12	18.25 (0.81)	18.15

1.800.833.3003

Tray Colors:

110
Black

167
Brown

Compartment Tray

- Perfect for school lunch programs or cafeteria-style feeding in correctional facilities.
- Textured surface resists scratching.
- All are FDA approved for food contact.
- Camwear® is made with virtually unbreakable polycarbonate.
- Budget is made with ABS.
- Penny-Saver is made with economical co-polymer.

Camwear Polycarbonate NSF Listed Colors: Beige (133), Black (110).

ABS and Co-Polymer trays are not NSF listed.

Two year prorated warranty for Camwear Compartment Trays against breakage.



PRORATED



Cambro Trays

saves 110 lbs of trash in disposable trays per day or 9.26 tons of trash per year from just trays for one school district.*

* This number is approximate. The average school district in the U.S. is about 10,000 students and the average number of in-session school days is 175.

Camwear Colors



Budget Colors



Penny-Saver Colors



PS1014

150CW, 100CW, 50CW, 45CW, 35CW, 10CW and SRB5CW reusable bowls fit in this tray and can be used to serve cereal, soup & salads.



BCT1014



BCT1014, PS1014 & 10146CW

CODE	DIMENSIONS W x L x D	CASE LBS. (CUBE)	LIST PRICE EA.
Camwear®			
10146CW	10" x 14½" x ¾"	20.59 (1.05)	\$ 13.70
Budget			
BCT1014	10" x 14½" x ¾"	18.11 (0.98)	9.95
Penny-Saver			
PS1014	10" x 14½" x ¾"	13.73 (0.83)	6.20

Case Pack: 24



PS1014 on OETR314 Open End Tray Rack.

2 X 2 Compartment Trays

- Perfect for school lunch programs or cafeteria-style feeding in correctional facilities.
- Gradual sloping compartment walls promote quick draining and faster drying.
- “Easy grip” handles ensure a better grip for children with smaller hands.
- 915CW, 100CW, SRB13CW and 50CW bowls fit in round compartment.
- 10CW and 150CW bowls fit in square compartment.

Camwear Polycarbonate NSF Listed Colors: Beige (133), Black (110).

Co-Polymer trays are not NSF listed.

Two year prorated warranty for Camwear Compartment Trays against breakage.



Styrofoam, the material that many disposable trays are made from, can make up to 30% of the trash volume in landfills.

Cambo Trays are made from an FDA approved material.

Camwear®



Co-Polymer



915CP



1596CW

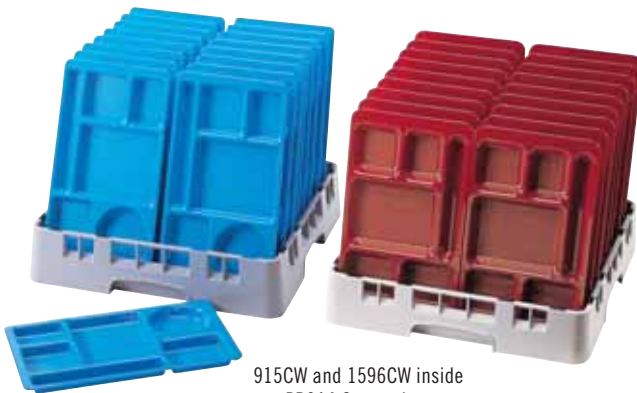

915CW and 1596CW inside two PR314 Camracks.

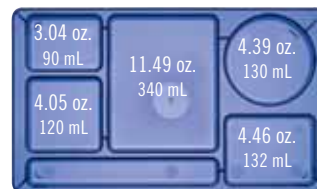

915CW & 915CP

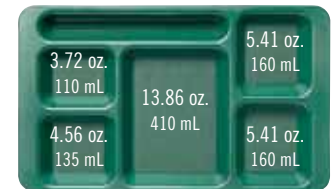

1596CW & 1596CP

CODE	DIMENSIONS W x L x D	CASE LBS. (CUBE)	LIST PRICE EA.
Camwear			
1596CW	9" x 15" x 7/8"	20.64 (0.56)	\$ 12.05
915CW	8 3/4" x 15" x 3/4"	17.34 (0.94)	12.05
Co-Polymer			
1596CP	9" x 15" x 7/8"	20 (0.60)	6.55
915CP	8 3/4" x 15" x 3/4"	10.14 (0.92)	6.55

Case Pack: 24

Compartment Serving Trays & Trapezoid Compartment Tray

Compartment Serving Trays

- For meal delivery in correctional facilities.
- Compartment configurations designed to meet all menu requirements.

Camwear® Polycarbonate
6-Compartment Colors: Navy (186), Cranberry (416), Yellow (145), Sherwood Green (119)
6-Compartment NSF Listed Colors: Beige (133), Black (110).
5-Compartment NSF Listed Color: Beige (133).

Co-Polymer Not NSF Listed Colors: Brown (167), Tan (161).

Withstands Temperatures From Polycarbonate: -40 to 210°F (-40° to 99°C).

Co-Polymer: -40 to 210°F (-40 to 99°C).



Trapezoid Compartment Trays

- Space saving tray for self serve correctional facility feeding.
- Offers seven deep compartments for ample, portion controlled servings.
- Serve soup and salad at the same time.

Camwear Colors: Beige (133).

Withstands Temperatures From Polycarbonate: -40 to 210°F (-40° to 99°C).

Trapezoid Compartment Trays are covered by the following U.S. Patent D 508,634.



NT9CP Co-Polymer Cup: For details contact your Cambro representative.



10146CW



14187TRCW

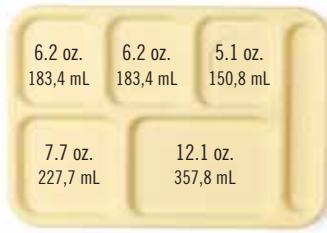

10146CW

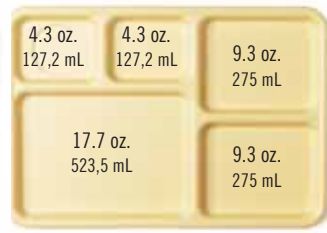

10145CW



14187TRCW

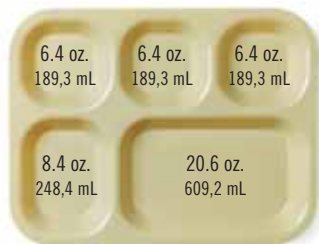

14105CW
 Also Available
 in 14105CP

CODE	DESCRIPTION	DIMENSIONS W x L x D	CASE LBS. (CUBE)	LIST PRICE EA.
Camwear Polycarbonate				
10146CW	6 Compartments	10" x 14½" x 1½"	20.59 (1.05)	\$ 13.70
14105CW	5 Compartments	10⅜" x 13⅞" x 1⅞"	19.8 (0.65)	15.00
10145CW	5 Compartments	10" x 14½" x 1½"	20.75(0.99)	14.95
Co-Polymer				
14105CP	5 Compartments	10⅜" x 13⅞" x 1⅞"	15.01 (0.67)	6.65

Case Pack: 24

CODE	DESCRIPTION	DIMENSIONS W x L x D	CASE LBS. (CUBE)	LIST PRICE EA.
Camwear Trapezoid Tray				
14187TRCW	7 Compartment	14" x 17⅜" x 1½"	22.36 (1.34)	\$ 26.90
Case Pack: 12				

Meal Delivery Trays & Separator® Compartment Tray

Meal Delivery Trays

- Three deep-dish food compartments for large portions.
- Snap-on cover fits securely.
- Textured surface minimizes scratching.

Camwear® Polycarbonate
Colors: Beige (133), Teal (414).
Lid Color: Clear (135).

Co-Polymer Not NSF Listed Colors:
 Teal (414), Brown (167), Tan (161).
Lid Color: White (148).

Withstands Temperatures From Polycarbonate: -40° to 210°F (-40° to 99°C).

Co-Polymer: -40° to 210°F (-40° to 99°C).



Separator Compartment Tray

- Six compartment tray designed specifically for in-cell feeding programs.
- Serve both hot and cold food from the same tray.
- Tray with cover separates each compartment to retain food temperature and reduce spills.
- Locking ridges on top of cover and bottom of tray ensure more secure stacking.

Camwear Polycarbonate
Color: Beige (133).
Lid Color: Clear (135).

Co-Polymer Not NSF Listed Colors:
 Teal (414), Brown (167), Tan (161).
Lid Color: Translucent (190).

Withstands Temperatures From Polycarbonate: -40° to 210°F (-40° to 99°C).

Co-Polymer: -40° to 210°F (-40° to 99°C).

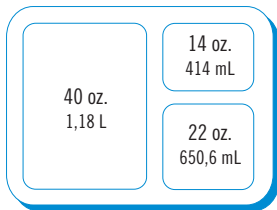

9113CW/9113CP

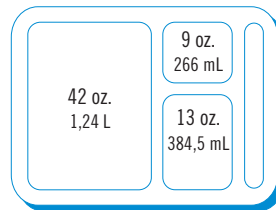

9114CW/9114CP

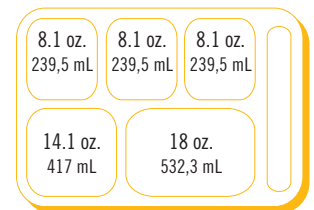

10146DCW/10146DCP

CODE	DESCRIPTION	DIMENSIONS W x L x D	CASE LBS. (CUBE)	LIST PRICE EA.
Camwear Polycarbonate				
9113CW	3 Compartments	9" x 11" x 2 ⁵ / ₁₆ "	24 (1.66)	\$ 16.05
9114CW	4 Compartments	9" x 11" x 2 ¹ / ₂ "	26 (1.67)	16.75
911CWC	Lid fits both trays	—	12.75 (0.68)	11.35
Co-Polymer				
9113CP	3 Compartments	9" x 11" x 2 ⁵ / ₁₆ "	16.83 (1.57)	6.80
9114CP	4 Compartments	9" x 11" x 2 ¹ / ₂ "	20 (1.67)	6.80
911CPC	Lid fits both trays	—	9.39 (0.66)	3.70

Case Pack: 24

1.800.833.3003

CODE	DESCRIPTION	DIMENSIONS W x L x D	CASE LBS. (CUBE)	LIST PRICE EA.
Camwear Polycarbonate				
10146DCW	6 Compartments	10" x 14 ³ / ₁₆ " x 1 ¹ / ₁₆ "	24.50 (1.08)	\$ 17.60
10146DCWC	Lid fits 10146DCW	—	9.79 (1.21)	9.35
Co-Polymer				
10146DCP	6 Compartments	9 ⁷ / ₈ " x 14" x 1 ³ / ₈ "	17.9 (1.56)	8.65
10146DCPC	Lid fits 10146DCP	—	14.75 (0.96)	5.05

Case Pack: 24

USA / Trays

Tray On Tray Meal Delivery System

Base Tray

- Combine pre-plated hot and cold food portions into a reusable, single service unit.
- Works as a tray or for in-cell feeding with the insert tray.
- Base tray has 5 compartments with 1 compartment for nesting the insert tray.

Camwear® Polycarbonate Color:
Beige (133).

Co-Polymer Not NSF Listed Colors:
Brown (167), Tan (161).

Withstands Temperatures From
Polycarbonate: -40° to 210°F (-40° to 99°C).
Co-Polymer: -40° to 210°F (-40° to 99°C).



1411CW



1411CW base tray with 853FH insert tray

11.8 oz. 349 mL	6.7 oz. 198,1 mL	6.7 oz. 198,1 mL
11.8 oz. 349 mL	23.6 oz. 697,9 mL	

1411CW/1411CP

CODE	DESCRIPTION	DIMENSIONS L x W x D	CASE LBS. (CUBE)	LIST PRICE EA
Camwear Polycarbonate				
1411CW	5 Compartments	14 ³ / ₁₆ " x 10 ⁹ / ₁₆ " x 1 ¹ / ₄ "	25.50 (1.25)	\$ 17.50
Co-Polymer				
1411CP	5 Compartments	14 ³ / ₁₆ " x 10 ⁹ / ₁₆ " x 1 ¹ / ₄ "	19.01 (1.19)	6.10

Case Pack: 24

Insert Trays

- Designed specifically for cook-chill applications as it can be covered with heat seal film or snap-on cover.
- Eight trays efficiently fit on a standard sheet pan or in an 18" x 26" (45,5 x 65,5 cm) wire rack.

Camwear Polycarbonate
Color: Beige (133).
Lid Color: Clear (135).

Co-Polymer
Colors: Brown (167), Tan (161).
Lid Color: Translucent (190).

Heat Resistant Plastic
Tray and Lid Color: Amber (150).

Withstands Temperatures From
Polycarbonate: -40° to 210°F (-40° to 99°C).
Co-Polymer: -40° to 210°F (-40° to 99°C).
Heat Resistant Plastic:
-40° to 375°F (-40° to 190°C).

Co-Polymer is not NSF listed. 853FH and 653FHC can be used in heated carts.



853FCW

853FCP

7 oz. 207 mL	21 oz. 621 mL
7 oz. 207 mL	

853FCW/853FCP/853FH

CODE	DESCRIPTION	DIMENSIONS L x W x D	CASE LBS. (CUBE)	LIST PRICE EA.
Camwear Polycarbonate				
853FCW	3 Compartments	8 ¹¹ / ₁₆ " x 6 ⁵ / ₁₆ " x 1 ⁷ / ₈ "	11.47 (0.76)	\$ 11.35
853FCWC	Lid for 853FCW		6.23 (0.28)	6.00
Co-Polymer				
853FCP	3 Compartments	8 ⁷ / ₁₆ " x 6 ¹ / ₄ " x 1 ¹ / ₈ "	9.79 (0.76)	5.45
853FCPC	Lid for 853FCP		4.61 (0.28)	2.90
Heat Resistant Plastic				
853FH	3 Compartments	8 ¹¹ / ₁₆ " x 6 ⁵ / ₁₆ " x 1 ⁷ / ₈ "	12.50 (0.77)	18.05
853FHC	Lid for 853FH		6.6 (0.46)	10.40

Case Pack: 24



TABLE SERVICE

Camwear® Dinnerware

5 5 YEAR PRORATED WARRANTY
AGAINST BREAKAGE

- Virtually unbreakable Camwear polycarbonate resists stains, odors and scratches.
- Textured surface on salad and dinner plates for long wear.
- Ideal for schools, cafeterias, day care centers and healthcare facilities.

Mug and stacking cup can be personalized.



133 Beige 148 White



110 Black 401 Slate Blue

Oval Platters & Compartment Plates



CODE	90SPCW	120CWP	93CW	HK93BCW*
DIAMETER	9" x 1 ¹ / ₁₆ "	12" x 9"	9"	9 ¹ / ₂ "
DESCRIPTION	Round, Soup Bowl	Oval, Narrow Rim	Narrow Rim	Heat Keeper Base
CASE PACK	48	24	48	12
CASE LBS. (CUBE)	16.25 (0.66)	8.76 (0.37)	17.50 (0.75)	9.75 (0.81)
LIST PRICE EACH	\$ 7.35	\$ 8.40	\$ 7.30	\$ 15.70

*HK93BCW is available in Beige (133) only.

Plates



CODE	10CWNR	9CWNR	825CWNR	725CWNR	65CWNR	55CWNR
DIAMETER	10"	9"	8 ¹ / ₄ "	7 ¹ / ₄ "	6 ³ / ₁₆ "	5 ¹ / ₂ "
DESCRIPTION	Narrow Rim	Narrow Rim	Narrow Rim	Narrow Rim	Narrow Rim	Narrow Rim
CASE PACK	48	48	48	48	48	48
CASE LBS. (CUBE)	23 (0.78)	15.88 (0.60)	15.01 (0.49)	11.23 (0.39)	9.41 (0.35)	7 (0.24)
LIST PRICE EACH	\$ 6.90	\$ 5.00	\$ 5.20	\$ 4.45	\$ 3.25	\$ 2.75

Bowls



Optional lid available

CODE	10CW	10CWL	35CW	45CW	50CW	60CW	100CW	150CW
APPROX. CAPACITY	9.4 oz.	—	8.4 oz.	5.0 oz.	15.3 oz.	10.9 oz.	12.5 oz.	16.7 oz.
DESCRIPTION	Square Bowl	Lid for 10CW Bowl	Bouillon	#3 ¹ / ₂ Fruit Cup	Nappie Bowl	#1 Grapefruit Bowl	5" Nappie	Square Bowl
CASE PACK	48	48	48	48	48	48	48	48
CASE LBS. (CUBE)	6.28 (0.47)	2.66 (0.15)	5.28 (0.25)	6 (0.33)	11.66 (0.62)	11.50 (0.56)	7.50 (0.61)	7.87 (0.60)
SHAPE	Square	Square	Round	Round	Round	Round	Round	Top/Rnd-Bottom/Sqr
OUTSIDE DIA.	Top: 4" x 4"	—	3 ¹⁵ / ₁₆ "	4 ³ / ₈ "	5 ¹ / ₄ "	6"	5"	Top: 5 ¹ / ₄ "
HEIGHT	1 ¹ / ₈ "	1 ¹⁵ / ₁₆ "	2 ¹ / ₈ "	1 ¹ / ₁₆ "	2 ¹ / ₈ "	1 ¹ / ₂ "	1 ¹ / ₁₆ "	2 ³ / ₈ "
LIST PRICE EACH	\$ 3.25	\$ 2.50	\$ 2.25	\$ 2.75	\$ 3.25	\$ 3.25	\$ 2.80	\$ 4.45

Mugs & Cups



CODE	75CW	96CW
APPROX. CAPACITY	7.5 oz.	9.6 oz.
DESCRIPTION	Stacking Cup	Mug
CASE PACK	48	48
CASE LBS. (CUBE)	8 (0.69)	10.39 (0.97)
MAX DIA. / HEIGHT	4 ¹ / ₁₆ " - 3 ³ / ₁₆ "	4 ³ / ₁₆ " - 3 ³ / ₄ "
FULL SIZE CAMRACK®	16C414	16C414
LIST PRICE EACH	\$ 4.25	\$ 4.25

Maximum diameter includes handle.

1.800.833.3003

Camwear® Heat Keepers



CODE	HK93CW	HK39
DESCRIPTION	3 Compartment Base and Cover	Heat Keeper Base and Cover for 9" Plate
CASE PACK	6	6
CASE LBS. (CUBE)	9.25 (0.82)	10.56 (0.76)
LIST PRICE EACH	\$ 28.95	\$ 29.60

HK93CW is available in Beige (133).

HK39 is available in Antique White (148).

HK93PMC

Camcarrier® for HK93CW available by special request. Call Cambro Customer Service for more information.

Versa Camcovers®

Serve hot food hot with the Versa Camcover, an elegant and efficient alternative to traditional metal covers.

- Withstands temperatures up to 300°F (149°C).
- Covers remain cool to the touch for easy handling.
- Lighter and quieter than metal covers.
- Elegant appearance without polishing.
- Keeps food warm longer than metal covers.
- Microwave safe.

For help selecting the correct size plate cover, refer to the Camcover Sizing Guide on our website at www.cambro.com. Or, send one of your plates to Cambro Customer Service for sizing.

Colors: Ivory (380), Granite Gray (191), Antique Parchment (101).



Square Versa Camcovers

- Square shape fits popular square plate designs.
- Secure stacking for improved server safety; the foot of the plate nests securely on the top of the cover below.
- Elegant appearance with less noise during service.

CODE	INSIDE DIAMETER	OUTSIDE HEIGHT	CASE LBS. (CUBE)	LIST PRICE EA.
Square				
1111SQVS	11 1/8"	2 7/8"	14.25 (0.72)	\$ 15.30
1212SQVS	12 1/8"	2 3/4"	15.50 (0.87)	20.35
99SMVS	9 7/8"	2 5/8"	10.00 (0.48)	12.75
1111SMVS	11 1/8"	2 3/4"	14.00 (0.73)	15.30
85SFVS	8 7/8"	2 3/4"	10.75 (0.43)	12.75
978SFVS	10"	2 3/4"	13.25 (0.59)	13.00
Round				
68VS	6 1/2"	2 3/16"	5.16 (0.46)	10.80
86VS	8 3/4"	2 5/8"	10 (0.47)	11.95
91VS	9 3/8"	2 11/16"	9.58 (0.52)	12.75
913VS	9 13/16"	2 11/16"	11.92 (0.51)	12.75
95VS	9 5/16"	2 11/16"	9.62 (0.52)	12.75
99VS	9 9/16"	2 5/8"	11.65 (0.52)	12.75
911VS	9 11/16"	2 3/4"	10.60 (0.63)	13.15
100VS	10"	2 11/16"	11.4 (0.52)	13.00
103VS	10 3/16"	2 11/16"	10.87 (0.57)	13.40
105VS	10 5/16"	2 11/16"	12.66 (0.59)	13.40
106VS	10 13/32"	2 3/16"	12.75 (0.72)	15.00
1010VS	10 3/8"	2 11/16"	13.54 (0.60)	14.20
1012VS	10 3/4"	2 11/16"	13.74 (0.58)	14.20
1014VS	10 7/8"	2 11/16"	13.02 (0.59)	14.20
116VS	11 3/8"	3 3/16"	14.49 (0.67)	15.30
120VS	12"	2 7/8"	15.25 (0.77)	19.60
124VS	12 1/4"	2 7/8"	14.56 (0.95)	20.35

Case Pack: 12



1111SQVS Fits 11" Syracuse Quadra Plate



85SFVS Fits 8 1/2" Oneida Sant' Andrea Fusion Plate
978SFVS Fits 9 7/8" Oneida Sant' Andrea Fusion Plate



99SMVS Fits 9" Steelite Distinction Metro Plate
1111SMVS Fits 11" Steelite Distinction Metro Plate



Microwave safe!



Perfect for heated carts!

Camwear® Polycarbonate Camcovers®

- Food stays hot and appetizing without re-heating.
- Ideal for use in heated carts up to 210°F (99°C).
- Virtually unbreakable polycarbonate will not dent or scratch.
- Lightweight for quiet service.
- Saves on labor with no polishing required.

Colors: Clear (152), Amber (153), Beige (133), Silver (486).

For help selecting the correct size plate cover, refer to the Camcover Sizing Guide on our website at www.cambro.com. Or, send one of your plates to Cambro Customer Service for sizing.



CODE	INSIDE DIAMETER	OUTSIDE HEIGHT	CASE LBS. (CUBE)	LIST PRICE EA.
806CW	8 ⁷ / ₁₆ "	2 ¹¹ / ₁₆ "	5.45 (0.61)	\$ 9.75
900CW	9 ⁷ / ₈ "	2 ³ / ₄ "	5.75 (0.60)	9.85
901CW	9 ⁵ / ₁₆ "	2 ¹³ / ₁₆ "	6.40 (0.62)	10.50
905CW	9 ¹ / ₂ "	2 ¹³ / ₁₆ "	7.75 (0.64)	10.80
909CW	9 ³ / ₄ "	2 ³ / ₄ "	6.58 (0.64)	10.75
9011CW	10"	2 ⁷ / ₈ "	6.42 (0.78)	11.70
9013CW	10"	2 ³ / ₄ "	7.62 (0.65)	11.70
1000CW	10 ³ / ₁₆ "	2 ¹¹ / ₁₆ "	7.25 (0.68)	11.65
1005CW	10 ¹ / ₁₆ "	2 ¹³ / ₁₆ "	7.73 (0.76)	11.90
1007CW	10 ⁵ / ₁₆ "	2 ³ / ₄ "	8.66 (0.78)	11.90
1013CW	10 ¹³ / ₁₆ "	2 ¹¹ / ₁₆ "	7.92 (0.78)	11.95
1101CW	11"	2 ¹¹ / ₁₆ "	7.81 (0.79)	11.90
1202CW	12 ⁵ / ₈ "	2 ³ / ₄ "	8.76 (0.95)	11.95

Case Pack: 12

Camwear® Polycarbonate Pitchers

- Made of virtually unbreakable Camwear polycarbonate.
- Lightweight for easy handling.
- Exclusive ice-control contoured lip and pour spout reduce spills.
- Slotted base allows for complete and sanitary drying.

Color: Clear (135). P600CW is also available in Amber (153).

Capacities calculated to rim.



P320CW, P480CW and P600CW
An industry standard. Broad base for stability, prevents tipping.



CODE	P320CW	P480CW	P600CW	P60CW
CAPACITY	32 oz.	48 oz.	60 oz.	60 oz.
HEIGHT WITH SPOUT	6¾"	7⅞"	8"	9"
DIAMETER WITH HANDLE	5¾"	6¼"	6¾"	7¼"
CASE LBS. (CUBE)	3.75 (0.61)	4.79 (0.79)	5.48 (0.93)	6.43 (1.04)
LIST PRICE EACH	\$ 10.70	\$ 12.90	\$ 13.65	\$ 15.75

Case Pack: 6 InStock Color: Clear (135).

PL60CW

Laguna® pitcher has a hammered texture that hides scratches. Design matches the Laguna Tumbler. Pour liquids from front or ice and liquid from sides.



PE600CW

Economy polycarbonate pitcher. Lightweight design. Pour liquids from front or ice and liquid from sides.



P64CW

Tapered design and drip-proof spout.



PC64CW

Three position lid can strain ice, free pour or close to protect contents.



PC34CW

Stackable Pitcher and Lid are made of virtually unbreakable polycarbonate and incorporate a frosted design to hide scratches.



CODE	PL60CW	PE600CW	P64CW	PC64CW	PC34CW
CAPACITY	60 oz.	60 oz.	64 oz.	64 oz.	34 oz.
HEIGHT WITH SPOUT	7⅞"	7⅞"	9¼"	9¼" with lid	7½" with lid
DIAMETER WITH HANDLE	6¾"	7⅞"	7⅞"	7⅞"	6⅝"
CASE LBS. (CUBE)	4.43 (1.15)	4.27 (1.21)	6.75 (1.31)	7.21 (1.19)	4.15 (0.93)
LIST PRICE EACH	\$ 9.35	\$ 9.35	\$ 15.75	\$ 20.25	\$ 9.50

Case Pack: 6 InStock Color: Clear (135).

Aliso® Barware, Goblets and Dessert Glass

Aliso Barware replicates the look, heft and clarity of glass with shatterproof polycarbonate. The smooth seamless appearance makes Aliso Barware a stylish choice for casual dining, outdoor events or poolside service.

- Barware items have large, heavy bases for stability.
- Bases designed for fast draining and complete drying.
- Chill or frost barware without concerns of thermal shock damage.

Color: Clear (135).

Capacities calculated to rim.



CODE	BWM10CW	BWW10CW	BWP14CW	BWB16CW	GB850CW	GB1200CW	DG3CW*
DESCRIPTION	Martini	Wine	Pilsner	Beer Mug	Goblet	Goblet	Dessert Glass
MAX DIAMETER	4 ¹³ / ₁₆ "	2 ¹⁵ / ₁₆ "	3 ¹ / ₄ "	4 ³ / ₄ "	2 ³ / ₄ "	2 ³ / ₄ "	2 ¹ / ₂ "
MAX HEIGHT	6 ⁷ / ₈ "	6 ³ / ₄ "	9 ⁹ / ₁₆ "	6 ¹ / ₄ "	6 ¹ / ₄ "	7 ⁷ / ₈ "	3"
FULL SIZE CAMRACK®	9S638	25S638	25S958	9S638	36S638	36S738	49S318
CAPACITY TO RIM	10.5 oz.	10.5 oz.	15.5 oz.	16 oz.	9 oz.	12.8 oz.	3.4 oz.
CASE PACK	12	24	24	12	24	24	72
CASE LBS. (CUBE)	6.50 (1.38)	8.25 (1.16)	15.78 (1.71)	9 (0.85)	5.42 (0.83)	6.74 (0.97)	8.5 (0.65)
LIST PRICE EACH	\$ 11.10	\$ 8.75	\$ 12.05	\$ 11.55	\$ 4.15	\$ 4.90	\$ 2.35

InStock Color: Clear (135).

*Cases only. No broken cartons.

Cambro® Tumblers

Cambro tumblers feature the look and feel of glass, but offer the cost savings and lightweight handling of break resistant plastic. These tumblers weigh up to 50% less than glass, making it easier and safer for wait staff to carry and serve

beverages. Cambro tumblers cost about 33% less than comparable glassware. Less breakage means lower replacement costs and less staff time spent cleaning up broken glass. Cambro tumblers feature stacking lugs for easy stacking,

transport and storage and are dishwasher safe. Expand your service options! Valued by restaurants, hospitals, hotels and schools, Cambro tumblers are ideal anywhere you want the upscale look of glass without the worry of breakage. Our

elegant designs are ideal for outdoor catering and resort use. Whatever your need, there is a Cambro tumbler perfect for your operation.

Elegant Design



HUNTINGTON®
Elegant Design, Unbreakable



LAGUNA®
Hammered Texture



NEWPORT
Fluted Design



DEL MAR®
Crackled Glass Look

RECOMMENDED USE:

Casual Dining, Fast Casual Dining, Poolside Service, Outdoor Dining, Catering, Bars, Hotels & Resorts, Country Clubs, Theme Parks, Cruise Ships, Colleges & Universities.

All Purpose



COLORWARE
Value Tumbler



CAMWEAR®
Virtually Unbreakable



PERSONALIZATION
Available on all tumblers



Camrack® IceExpress Glass Filler

- Dramatically reduces banquet set-up time.
- Fills 25 glasses with ice all at once.
- Reduces breakage and risk of contamination.
- Ice falls directly into glasses with no spills or drips.

See Camrack section for more details.

 Add your logo to promote your establishment and build customer loyalty. See personalization page for details.

- Disposable lids fit tightly on Newport, Laguna, and Colorware tumblers, avoiding spills.
- Provides a “green” solution to reduce the waste of using disposable cups for kids’ drinks.
- Reusable tumblers save operators the expense of replacing disposable kids’ cups.
- Tumblers are available in clear, which allows for visibility of contents.
- Doubles as an employee drink cup that requires a lid.
- Lids have tumbler code imprinted on them for easy cross reference.
- Includes a cross slot for straws.
- Tumblers can be personalized with logos or exclusive designs.



Disposable Lids for Colorware Tumblers



LID CODE	CL900P	CL950P
FITS TUMBLERS	900P / 900P2	950P / 950P2
TUMBLER CAPACITY	9.7 oz.	9.8 oz.
CASE PACK	1,000	1,000
CASE LBS. (CUBE)	6 (1.05)	6 (0.85)
LIST PRICE PER CASE	\$ 97.75	\$ 71.30

Color: Translucent (190). Disposable lids are sold in full cases only. No broken cartons.

Disposable Lids for Laguna® Tumblers



LID CODE	CLLT6	CLLT10	CLLT12
FITS TUMBLERS	LT6	LT10	LT12
TUMBLER CAPACITY	6 oz.	10 oz.	12 oz.
CASE PACK	1,500	1,000	1,000
CASE LBS. (CUBE)	6 (1.07)	5 (0.98)	6 (1.09)
LIST PRICE PER CASE	\$ 110.25	\$ 89.25	\$ 97.75

Color: Translucent (190). Disposable lids are sold in full cases only. No broken cartons.

Disposable Lids for Newport Tumblers



LID CODE	CLNT5	CLNT8	CLNT10	CLNT12
FITS TUMBLER	NT5	NT8	NT10	NT12
TUMBLER CAPACITY	6.4 oz.	8 oz.	10 oz.	12.6 oz.
CASE PACK	1,500	1,000	1,000	1,000
CASE LBS. (CUBE)	6 (1.07)	5 (0.85)	5 (1.0)	5 (0.98)
LIST PRICE PER CASE	\$ 110.25	\$ 69.60	\$ 89.25	\$ 97.75

Color: Translucent (190). Disposable lids are sold in full cases only. No broken cartons.

Camwear® Huntington® & Newport Tumblers

Huntington Tumblers

- Feature the elegant look and feel of glass without the high replacement costs.
- Made of virtually unbreakable polycarbonate.
- Lightweight.
- Stacking lugs to prevent sticking.
- Three sided drain bottom for easy washing and drying.

Colors: Azure Blue (196), Clear (135).

Capacities calculated to rim.



CODE	HT5CW	HT8CW	HT10CW	HT120CW	HT12CW	HT14CW	HT16CW	HT22CW
MAX DIAMETER	2 ¹¹ / ₃₂ "	2 ¹ / ₁₆ "	2 ¹³ / ₁₆ "	3"	3 ³ / ₈ "	3 ¹ / ₄ "	3 ⁵ / ₁₆ "	3 ¹ / ₂ "
MAX HEIGHT	3 ³ / ₁₆ "	4 ⁷ / ₁₆ "	4 ¹³ / ₁₆ "	5"	3 ³ / ₄ "	4 ⁷ / ₈ "	5 ¹ / ₂ "	6 ¹ / ₁₆ "
FULL SIZE CAMRACK®	49S434	36S418	36S434	25S434	25S418	25S434	25S534	25S638
CAPACITY TO RIM	5 oz.	8 oz.	10 oz.	12 oz.	12 oz.	14 oz.	16 oz.	22 oz.
CASE LBS. (CUBE)	3.86 (0.27)	5.22 (0.39)	7.2 (0.43)	7.18 (0.52)	6.98 (0.63)	3.42 (0.58)	8.50 (0.70)	10.55 (0.87)
LIST PRICE EACH	\$ 2.58	\$ 2.70	\$ 2.81	\$ 2.94	\$ 2.88	\$ 3.23	\$ 3.76	\$ 4.70

Case Pack: 36 InStock Color: Clear (135).

Newport Tumblers

- Fluted design features the upscale look of glass with the safety benefits and cost savings of plastic.
- Impact resistant SAN plastic resists chips and breaks.
- Stacking lugs prevent sticking.
- Sani-Rim lip provides a sanitary drinking surface.

Colors: Clear (152), Blush (409), Amber (153), Slate Blue (401).

Capacities calculated to rim.

Liquids in SAN cannot exceed 185°F.



CODE	NT5	NT8	NT9	NT10	NT12	NT14	NT16	NT20
MAX DIAMETER	2 ¹ / ₂ "	2 ¹¹ / ₁₆ "	3 ¹ / ₄ "	2 ¹³ / ₁₆ "	3"	3 ³ / ₈ "	3 ¹ / ₄ "	3 ¹ / ₁₆ "
MAX HEIGHT	3 ¹¹ / ₁₆ "	4"	3 ⁵ / ₁₆ "	4 ⁵ / ₁₆ "	5 ¹ / ₈ "	5"	5 ³ / ₄ "	6 ¹ / ₂ "
FULL SIZE CAMRACK	36S318	36S418	25S318	36S434	25S434	25S434	25S534	25S638
CAPACITY TO RIM	6.4 oz.	8.0 oz.	9.3 oz.	10 oz.	12.6 oz.	14 oz.	16.4 oz.	22 oz.
CASE LBS. (CUBE)	3.6 (0.31)	4.3 (0.34)	4.4 (0.36)	5.26 (0.45)	5.62 (0.49)	6.1 (0.54)	6.8 (0.60)	8.6 (0.76)
LIST PRICE EACH	\$ 1.47	\$ 1.52	\$ 1.66	\$ 1.81	\$ 1.88	\$ 2.18	\$ 2.25	\$ 2.78

Case Pack: 36 InStock Color: Clear (152).

Laguna® & Del Mar® Tumblers

Laguna Tumblers

- Hammered texture hides water spots and scratches.
- Made of impact resistant SAN.
- Lightweight and easy to carry.

Colors: Clear (152), Spanish Green (427).

Capacities calculated to rim.

Laguna Tumblers are covered by the following U.S. Patent D 405,319.

Liquids in SAN cannot exceed 185°F.



CODE	LT6	LT8	LT10	LT12	LT14	LT16	LT22
MAX DIAMETER	2½"	2¾"	2⅞"	3⅞"	3¼"	3⅝"	3⅞"
MAX HEIGHT	4¼"	4¼"	4¾"	5"	5⅞"	5½"	6⅞"
FULL SIZE CAMRACK®	36S418	36S418	36S434	25S434	25S434	25S534	16S534
CAPACITY TO RIM	6 oz.	8 oz.	10 oz.	12 oz.	14 oz.	16 oz.	22 oz.
CASE LBS. (CUBE)	4.28 (0.37)	5.10 (0.44)	5.50 (0.55)	6.44 (0.61)	6.55 (0.7)	8 (0.82)	10.09 (1.05)
LIST PRICE EACH	\$ 1.84	\$ 2.01	\$ 2.08	\$ 2.28	\$ 2.41	\$ 2.67	\$ 3.00

Case Pack: 36 InStock Color: Clear (152).

Del Mar Tumblers

- Crackled glass look features the lightweight handling of plastic.
- Thick sturdy base and rolled rim edge for added stability.
- Made of impact resistant SAN plastic.

Colors: Clear (152), Ruby Red (156), Sapphire Blue (608), Light Amber (609).

Capacities calculated to rim.

Del Mar Tumblers are covered by the following U.S. Patent D 478,778 S.

Liquids in SAN cannot exceed 185°F.



CODE	D8	D12	D14	D16	D24
MAX DIAMETER	2⅝"	2⅝"	3¼"	3⅞"	3⅞"
MAX HEIGHT	4⅜"	4¾"	4⅜"	5⅝"	6⅞"
FULL SIZE CAMRACK	36S418	25S434	25S418	25S534	25S638
CAPACITY TO RIM	8 oz.	12 oz.	14 oz.	16 oz.	24 oz.
CASE LBS. (CUBE)	4.75 (0.35)	6.63 (0.49)	7.50 (0.62)	8.50 (0.66)	11.13 (0.91)
LIST PRICE EACH	\$ 1.41	\$ 1.49	\$ 1.84	\$ 1.89	\$ 2.45

Case Pack: 36 InStock Color: Clear (152).

Colorware Tumblers

- A classic value tumbler ideal for casual dining.
- Textured on the outside to resist scratching.
- Made of impact resistant SAN.
- Interior stacking lugs for easy storing.
- Sani-Rim lip provides a sanitary drinking surface.

Colors: Blush (409), Slate Blue (401), Clear (152), Amber (153), Ruby Red (156).

Capacities calculated to rim.
Liquids in SAN cannot exceed 185°F.



CODE (72 PACK)	500P	800P	900P	950P	1200P	1600P	2000P	—
CODE (24 PACK)	500P2	800P2	900P2	950P2	1200P2	1600P2	2000P2	3200P2
MAX DIAMETER	2¼"	2⅝"	3⅜"	2¾"	2⅝"	3⅜"	3⅜"	3⅝"
MAX HEIGHT	3⅝"	4"	3¼"	4⅜"	5⅜"	5¾"	6½"	7¼"
FULL SIZE CAMRACK®	49S318	36S418	25S318	36S418	25S434	25S534	25S638	16S738
CAPACITY TO RIM	5.2 oz.	7.8 oz.	9.7 oz.	9.8 oz.	12.6 oz.	16.4 oz.	22 oz.	32 oz.
P CODE-CASE PACK	72	72	72	72	72	72	72	—
P2 CODE-CASE PACK	24	24	24	24	24	24	24	24
72 PACK-CASE LBS. (CUBE)	7.56 (0.46)	7.89 (0.56)	8.45 (0.69)	9.54 (0.73)	5.04 (0.84)	14.76 (1.07)	17.25 (1.30)	—
24 PACK-CASE LBS. (CUBE)	2.17 (0.16)	2.75 (0.20)	2.91 (0.23)	3.30 (0.25)	3.86 (0.28)	4.75 (0.54)	5.81 (0.45)	7.91 (0.72)
LIST PRICE EACH - 72 PACK	\$ 0.97	\$ 1.17	\$ 1.97	\$ 1.36	\$ 1.51	\$ 1.79	\$ 2.21	—
LIST PRICE EACH - 24 PACK	\$ 1.04	\$ 1.26	\$ 2.15	\$ 1.48	\$ 1.60	\$ 1.90	\$ 2.41	\$ 3.59

InStock Color: Clear (152).

Coca-Cola® Tumblers

- Colorware Tumblers featuring the Coca-Cola trademark logo in White.
- Available only to Coca-Cola fountain customers for foodservice use.

Colors: Clear (152).

Coca-Cola Logo is imprinted in White only.

These trademarked tumblers may not be resold at retail and are available only for distribution to Coca-Cola Fountain customers for food service use.

Liquids in SAN cannot exceed 185°F.



CODE	20CC	32CC
MAX DIAMETER	3⅜"	3⅝"
MAX HEIGHT	6½"	7¼"
FULL SIZE CAMRACK	25S638	16S738
CAPACITY TO RIM	22 oz.	32 oz.
CASE PACK	72	24
CASE LBS. (CUBE)	17.25 (1.30)	7.85 (0.70)
LIST PRICE EACH - 72 PACK	\$ 2.61	—
LIST PRICE EACH - 24 PACK	—	\$ 3.93

Camwear® Tumblers & Camliters®

Camwear Tumblers

- The look and feel of glass but made of virtually unbreakable polycarbonate.
- Textured exterior surface resists scratching.
- Smooth interior promotes easy cleaning.
- Designed with a Sani-Rim lip for sanitary drinking.

Color: Clear (152).

Capacities calculated to rim.



CODE	500CW	800CW	850CW	950CW	1200CW	1600CW
MAX DIAMETER	2¼"	2⅝"	3⅜"	2¾"	2⅝⅙"	3⅞"
MAX HEIGHT	3⅝"	3⅞"	3⅞⅙"	4⅝"	5⅝⅙"	5¼"
FULL SIZE CAMRACK®	49S318	36S418	25S418	36S418	25S434	25S534
CAPACITY TO RIM	5.4 oz.	8 oz.	9.1 oz. (Heavy Wall)	9.6 oz.	13 oz.	17 oz.
CASE LBS. (CUBE)	4.24 (0.28)	5.53 (0.42)	9.50 (0.61)	6.50 (0.52)	8.25 (0.67)	9.50 (0.80)
LIST PRICE EACH	\$ 1.55	\$ 1.90	\$ 4.85	\$ 2.20	\$ 2.50	\$ 3.10

Case Pack: 48

Camwear Camliter Beverage Decanters

- Ideal for serving juice or wine on buffet lines or table side.
- Virtually unbreakable Camwear polycarbonate will not dent or scratch. Lightweight.
- Camliters ship with spill-proof flat lids.

- Pour Spout Lid, ordered separately, protects contents while allowing a free pour.

Color: Clear (135).

Lid Color: White (148).



CODE	CAPACITY	HEIGHT	CASE LBS. (CUBE)	LIST PRICE EA.
Camliters with Flat Lids				
WW1500CW	1½ L	10"	8.04 (1.56)	\$ 13.60
WW1000CW	1 L	9¾"	7 (1.13)	10.45
WW500CW	½ L	7⅞"	4.25 (0.69)	7.70
WW250CW	¼ L	6¼"	2.14 (0.32)	4.65

Lids

WW1000LS (Pour Spout Lid for 1½ L, 1 L and ½ L)	0.2 (0.11)	0.95
WW1000L (Replacement Lid for 1½ L, 1 L and ½ L)	0.62 (0.06)	0.95
WW250L (Replacement Lid for ¼ L)	0.13 (0.06)	0.95

Case Pack: 12 InStock Color: Clear (135).



WW1000L - Flat Lid



WW1000LS - Pour Spout



Beverage Dispenser, Pail With Bail & Swirl Bowls®

6-Gallon Beverage Dispenser



- Perfect for mixing and serving concentrated beverages.
- Standard and metric graduations are printed on dispenser.
- Impact resistant polyethylene withstands temperatures from -40°F to 160°F (-40°C to 70°C).

CODE	CASE LBS. (CUBE)	LIST PRICE EA.
DSPR6	3.79 (1.52)	\$ 45.35
Case Pack: 1 Color: White (148). DSPR6 Capacity: 6 gallons (22,7 L).		



Pail with Bail – Poly



- A large, multi-purpose, 22 quart (20,8 L) pail, ideal for mixing, storing and transporting.
- Durable polyethylene withstands temperatures from -40°F to 160°F (-40°C to 70°C), and is stain resistant.
- Snap-tight, thumb tab cover sold separately.

CODE	CASE LBS. (CUBE)	LIST PRICE EA.
PWB22	14.43 (3.29)	\$ 26.50
RFSC12(cover)	3.75 (0.42)	4.95
Case Pack: 6 Color: White (148). All graduations are approximate.		



Swirl Bowls

- Ideal for hot or cold side dishes, desserts, dips, or fruit.
- Fits on a plate or stacks in place on a buffet station.
- Available in virtually unbreakable Camwear® polycarbonate or break resistant SAN.

Colors:
SRB5CW and SRB13CW available in: Clear (135), Black (110), White (148).
SRB5 and SRB13 available in: Clear (152), Black (110), White (148).



CLSRB5 Disposable lid not NSF listed.



Disposable lid available



SRB13CW

SRB5CW

CODE	CAPACITY	CASE PACK	CASE LBS. (CUBE)	LIST PRICE EA.
Camwear Polycarbonate				
SRB5CW	5 oz.	24	3 (0.23)	\$ 2.25
SRB13CW	13 oz.	24	5.15 (0.33)	4.45
SAN				
SRB5	5 oz.	24	3 (0.23)	1.85
SRB13	13 oz.	24	4.46 (0.33)	3.40
Disposable Lid				
CLSRB5	—	1,000	10 (2.24)	146.45

Disposable Lid Color: Clear (152).

Camwear® Wine Buckets, Punch Bowls & Bud Vase

Wine Buckets

- Chill and showcase wine or champagne.
- Tough Camwear polycarbonate won't crack or break and is easy to clean.
- Chrome stand available for space saving table side service.

Color: Clear (135).
Stand Color: Chrome (136).



CODE	SIZE D x H	CASE LBS. (CUBE)	LIST PRICE EA.
Bucket			
WC100CW	8" x 9½"	2 (0.50)	\$ 40.95
WC100CWNH (without handles)	8" x 9"	1.74 (0.50)	23.55
Stand			
WCS30	—	4 (1.59)	92.15

Case Pack: 1



Pebbled Pedestal Punch Bowls

- Perfect for parties, weddings and receptions.
- Made of virtually unbreakable Camwear polycarbonate.
- Attractive pebbled exterior is scratch resistant and smooth interior is easy to clean.

Color: Pebbled (176).

Capacities are calculated to rim.



CODE	INSIDE DIAMETER	APPROX. CAPACITY	CASE LBS. (CUBE)	LIST PRICE EA.
PPB15	15"	11.2 qt.	2.6 (1.27)	\$ 74.40
PPB18	18"	20.2 qt.	4.6 (2.12)	98.15
PPB23	23"	40.0 qt.	8.3 (4.38)	168.85

Case Pack: 1

Bud Vase

- Ideal for dining rooms, cafeteria tables and patient or room service trays.
- Made of virtually unbreakable Camwear polycarbonate.
- Fill with a fresh rose bud or a colorful faux flower.

Colors: Clear (135), White (148).



CODE	DESCRIPTION	CASE LBS. (CUBE)	LIST PRICE EA.
BV6CW	6" Bud Vase	2.21 (0.36)	\$ 3.50

Case Pack: 12

Promote Your Brand

Personalize tumblers, barware, pitchers or other table service items with your logo or design. Use personalized drinkware in promotions.

Food storage products can also be personalized to identify menu items, add fill lines for recipes or to add instructions in multiple languages to help ensure product quality and consistency.

 Look for this icon that identifies items that can be personalized.

IMPRINTING TABLE SERVICE AND STORAGE ITEMS

Minimum Quantity: 6 Cases

Sample Turnaround Time: 7-10 business days after receipt of approved artwork

Print Area: ¼" to 4", subject to printable area on each item

PERSONALIZATION CHARGES (NET)

Sample Charge: \$ 50.00 (Charge will be billed on sample order, credited on first purchase order)

Plate Charge: \$ 75.00 (Billed on sample order, one time charge)

Set-Up Charge: \$ 50.00 (per order)

Cost Per Imprint: \$ 0.30 (per side)

HOW TO ORDER A SAMPLE

1. Request a Sample

Contact your local Cambro representative to complete and submit your sample request to Cambro.

2. Provide Artwork

Provide ready to use artwork, digital format only. Completed sample request form must be submitted to Cambro **PRIOR** to artwork being sent. If artwork is incomplete, graphic support services are available at \$ 50.00 per hour.

3. Submit Artwork

E-mail artwork to your Cambro Rep or direct to Cambro at letsgetpersonal@cambro.com. Title e-mail subject with logo name and provide contact info. **File dimensions:** 100% reproduction size, 300dpi resolution.

File type:

Adobe® Illustrator®, Photoshop®.

File format: jpeg, tiff, and eps.

Or mail digital artwork to:
Cambro Attn: Kristie Patterson,
7601 Clay Avenue,
Huntington Beach, CA 92648.

4. Questions

Call Kristie Patterson
at 714-230-4125 direct
or 800-854-7631 ext. 4125.

5. Sample Approval

A signed sample approval form must be faxed to Cambro customer service prior to processing any purchase orders. This is included with each sample.



CHOOSE ANY ONE OF THESE STANDARD IMPRINT COLORS



Due to the catalog printing process, the colors shown may not be exact.

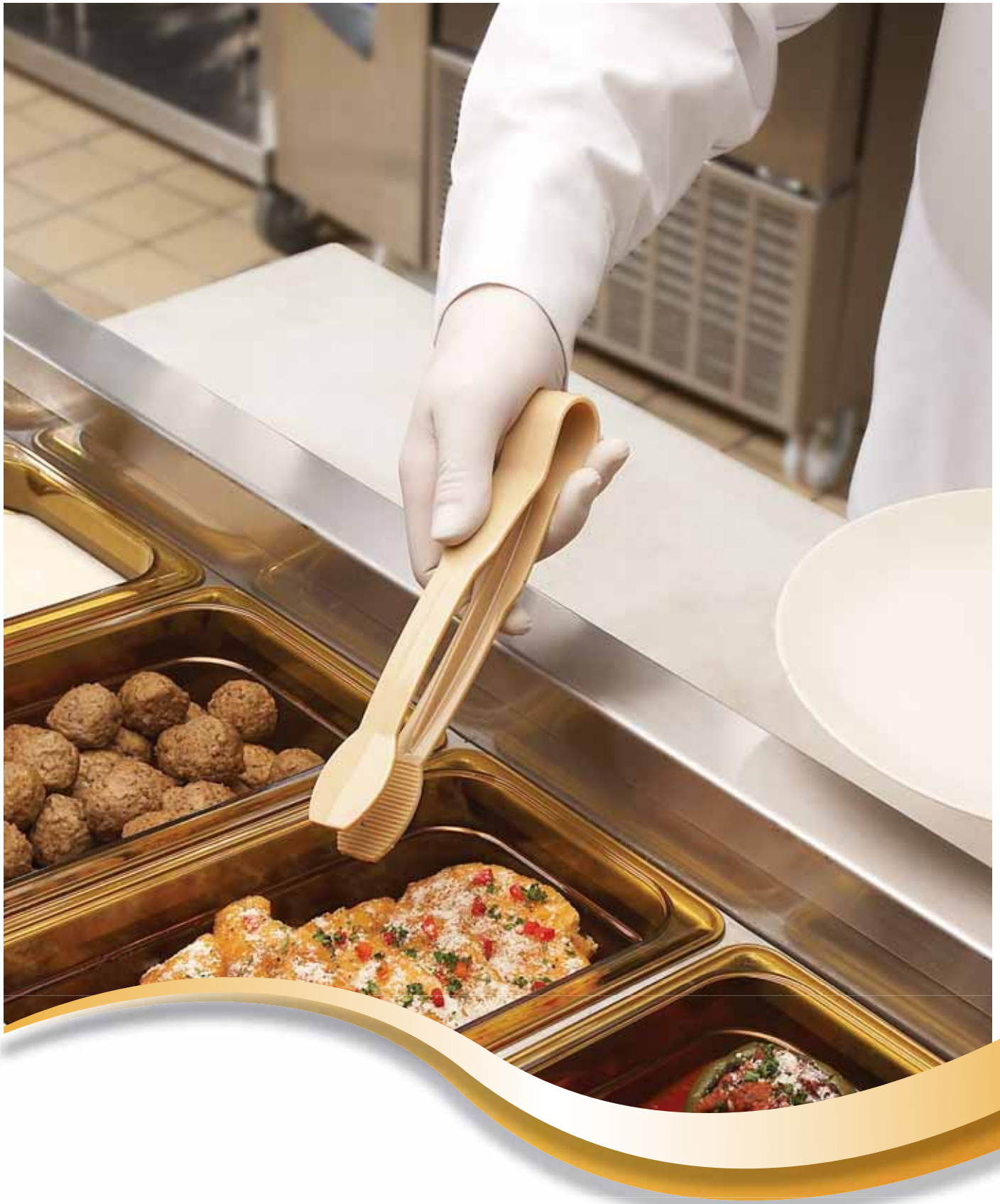

DISPLAY

Deli Crock & Platter

- Prep, store and serve all in one with contemporary style at an economical price.
- Crocks and platter are made of SAN, making them impact, stain and chip resistant.
- Ideal for supermarket delis, sandwich shops, buffets and catered events.
- Handed covers are made of crystal clear, virtually unbreakable Camwear® polycarbonate.

Crock and Platter Colors: Clear (152), Black (110), White (148), Red (404).

Crock Cover Color: Clear (135).

Deli Crocks are covered by the following U.S. Patents D 504,283 S, D 503,871 S & D 494,419 S. Scalloped Food Service Cover is covered by the following U.S. Patent D 509,705 S.



Prep, stack, store and serve all in one.



Interstacking saves storage space.



Avoid cross contamination and keep food fresh by using clear cover with handle.



Lid can be used as a riser to provide additional height on the buffet table or in a deli display case.



Cover doubles as a false bottom for presentation and to reduce waste.

Crocks & Platter



CODE	DC5	DC10	DP15
DESCRIPTION	Crock	Crock	Platter
DIM. W x D x H	10 ¹ / ₁₆ " x 6 ¹³ / ₁₆ " x 3 ³ / ₁₆ "	13 ³ / ₁₆ " x 10 ⁷ / ₁₆ " x 3 ³ / ₁₆ "	11 ³ / ₁₆ " x 15 ³ / ₄ " x 2 ³ / ₁₆ "
APPROX. CAPACITY	2.2 qt.	4.9 qt.	3.4 qt.
CASE LBS. (CUBE)	3.93 (0.30)	7.1 (1.4)	6.25 (0.49)
LIST PRICE EACH	\$ 10.90	\$ 15.00	\$ 12.85

Case Pack: 6

Covers



CODE	DCC5 fits DC5	DCC10 fits DC10
DIM. W x D x H	9 ³ / ₁₆ " x 5 ⁷ / ₁₆ " x 1 ¹ / ₁₆ "	12 ³ / ₁₆ " x 9 ⁹ / ₁₆ " x 1 ¹ / ₁₆ "
APPROX. CAPACITY	0.9 qt.	2.0 qt.
CASE LBS. (CUBE)	2.50 (0.21)	5 (0.38)
LIST PRICE EACH	\$ 7.65	\$ 10.65

Case Pack: 6



ShowFest® Display Bowls & Trays

- Showcase cold deli, buffet and salad bar items.
- Made from SAN for impact, stain, break & chip resistance.
- Variety of shapes and sizes to make the best use of display area.

Colors: Black (110), White (148).

Triangle trays are covered under U.S. Patent D 419,364.



Scalloped Ovals



CODE	SFV1015
DIM. W x L x H	10" x 15" x 2½"
APPROX. CAPACITY	3.0 qt.
CASE LBS. (CUBE)	4.8 (0.63)
LIST PRICE EACH	\$ 17.45
Case Pack: 6	

Scalloped Rectangles



CODE	SFR1012
DIM. W x L x H	10" x 12½" x 3"
APPROX. CAPACITY	4.5 qt.
CASE LBS. (CUBE)	5.99 (0.46)
LIST PRICE EACH	\$ 16.75
Case Pack: 6	



Octagonals



CODE	SFG1012	SFG1015	SFG820	SFG1220
DIM. W x L x H	10" x 12" x 2"	10" x 15" x 2"	8" x 20" x 2"	12" x 20" x 2"
APPROX. CAPACITY	3.0 qt.	3.5 qt.	4.0 qt.	6.0 qt.
CASE LBS. (CUBE)	5.16 (0.41)	6.25 (0.51)	6.64 (0.53)	9.82 (0.78)
LIST PRICE EACH	\$ 16.75	\$ 17.85	\$ 19.00	\$ 22.80
Case Pack: 6				

Triangles



CODE	SFT1010	SFT1212	SFT1515
DIM. W x L x H	10" x 10" x 12" x 2½"	12" x 12" x 15" x 2½"	15" x 15" x 20" x 2½"
APPROX. CAPACITY	2.0 qt.	3.0 qt.	4.5 qt.
CASE LBS. (CUBE)	2.8 (0.40)	3.8 (0.54)	7.1 (0.82)
LIST PRICE EACH	\$ 15.85	\$ 17.15	\$ 19.90
Case Pack: 6			

Camwear® Polycarbonate Bowls

Round Pebbled Bowls

- Textured on the outside for an elegant look, smooth on the inside for easy cleaning.
- Made of virtually unbreakable Camwear polycarbonate for years of dependable service.
- Ideal for fruit, salads, snacks and desserts.

Color: Pebbled (176).

Capacities are calculated to rim.



Ribbed Bowls

- Stylish, contemporary appearance for a dramatic presentation.
- Made of virtually unbreakable Camwear polycarbonate that won't break like glass.
- Bowls are durable and lightweight. Will not chip and crack like acrylic.
- Resistant to stains, acids and odors.

Colors: Clear (135), Black (110), White (148)*.

* Rectangular Ribbed Bowls are not available in White (148).

Capacities are calculated to rim.



Round Pebbled Bowls



CODE	PSB6	PSB8	PSB10	PSB12
INSIDE DIAMETER	6"	8"	10"	12"
APPROX. CAPACITY	18.8 oz.	1.8 qt.	3.2 qt.	5.8 qt.
CASE PACK	12	12	12	12
CASE LBS. (CUBE)	2.50 (0.19)	4.43 (0.43)	9.25 (0.79)	12.75 (1.30)
LIST PRICE EACH	\$ 3.55	\$ 6.05	\$ 11.95	\$ 15.45

InStock Color: Pebbled (176).

Round Pebbled Bowls



CODE	PSB15	PSB18	PSB23
INSIDE DIAMETER	15"	18"	23"
APPROX. CAPACITY	11.2 qt.	20.2 qt.	40 qt.
CASE PACK	4	4	4
CASE LBS. (CUBE)	7 (1.19)	12.25 (2.09)	19.50 (4.08)
LIST PRICE EACH	\$ 25.15	\$ 40.05	\$ 61.00

InStock Color: Pebbled (176).

Rectangular Ribbed Bowls



CODE	RSB912CW	RSB1014CW	RSB1419CW
INSIDE DIAMETER	9" x 12 $\frac{1}{2}$ "	10 $\frac{3}{4}$ " x 14 $\frac{9}{16}$ "	14 $\frac{1}{4}$ " x 19 $\frac{3}{8}$ "
APPROX. CAPACITY	2.9 qt.	5 qt.	12 qt.
CASE PACK	12	4	4
CASE LBS. (CUBE)	8.75 (0.66)	4.64 (0.51)	8.85 (1.11)
LIST PRICE EACH	\$ 12.65	\$ 18.50	\$ 30.00

Rectangular Ribbed Bowls are not available in White (148).

Round Ribbed Bowls



CODE	RSB6CW	RSB8CW	RSB10CW	RSB12CW
INSIDE DIAMETER	6"	8"	10"	12"
APPROX. CAPACITY	18.8 oz.	1.65 qt.	3.2 qt.	5.8 qt.
CASE PACK	12	12	12	12
CASE LBS. (CUBE)	6.9 (0.2)	5.92 (0.51)	11.50 (0.91)	19.75 (1.69)
LIST PRICE EACH	\$ 4.55	\$ 8.85	\$ 16.20	\$ 27.00



CODE	RSB15CW	RSB18CW	RSB23CW
INSIDE DIAMETER	15"	18"	22 $\frac{7}{8}$ "
APPROX. CAPACITY	11.2 qt.	20.2 qt.	40 qt.
CASE PACK	4	4	4
CASE LBS. (CUBE)	8.25 (1.32)	13.4 (2.05)	22 (4.00)
LIST PRICE EACH	\$ 34.90	\$ 50.25	\$ 75.70

InStock Color: Black (110).

Bell Shaped, Budget & Fiberglass Bowls

Camwear® Bell-Shaped Pebbled Bowls

- Perfect for showcasing fruits and salads.
- A versatile alternative to Cambro traditional Round Pebbled Bowls.
- Made from virtually unbreakable Camwear polycarbonate.

Color: Pebbled (176).

Capacities are calculated to rim.



CODE	BSB10	BSB12	BSB18
INSIDE DIAMETER	9 $\frac{7}{8}$ "	12"	18"
APPROX. CAPACITY	2.1 qt.	4.0 qt.	12.5 qt.
CASE PACK	12	4	4
CASE LBS. (CUBE)	7.25 (0.48)	4 (0.52)	9 (1.50)
LIST PRICE EACH	\$ 11.95	\$ 15.40	\$ 32.45

Color: Pebbled (176).

Budget Salad Bowls

- An economical serving choice for fruit, salads, snacks and desserts.
- Impact resistant FDA approved material resists stains, acids and odors.

Colors: Birch (174), Black (110).

Capacities are calculated to rim.



CODE	SB55	SB60	SB80
INSIDE DIAMETER	5 $\frac{11}{16}$ "	6"	8"
APPROX. CAPACITY	10.9 oz.	12.6 oz.	31.2 oz.
CASE LBS. (CUBE)	8.75 (0.56)	11 (0.54)	19.25 (1.07)
LIST PRICE EACH	\$ 1.85	\$ 2.20	\$ 4.45

Case Pack: 72



Fiberglass Bowls

- Combines the look of warm wood grains with the durability of fiberglass.
- Colors won't fade even after years of service and washing.

Color: Dark Basketweave (301).

For a swatch of this color and pattern, see Camtray group section.

Capacities are calculated to rim.



CODE	6F	8F
INSIDE DIAMETER	6 $\frac{1}{8}$ "	8"
APPROX. CAPACITY	14.3 oz.	31.2 oz.
CASE LBS. (CUBE)	2.17 (0.15)	4.25 (0.23)
LIST PRICE EACH	\$ 11.65	\$ 13.55

Case Pack: 12



Camwear® Polycarbonate Display Covers & Trays

- Display covers protect freshness of pastries, breads and desserts.
- Virtually unbreakable Camwear polycarbonate features the upscale look of glass.
- Openings on side or end provide quick and easy access to contents without removing cover.

Display Covers Color: Clear (135).

Display Trays Color: Clear (135), Black (110).



Display Trays are stackable.
Display Trays cannot be personalized.
Refer to page 18 for Market Tray information.



RD1220CW



RD1220CWH



DD1220BECW



RD1200CW

CODE	APPROX. DIMENSIONS W x D x H*	DESCRIPTION	CASE PACK	CASE LBS. (CUBE)	LIST PRICE EA.
Display Covers					
RD1200CW	12" x 12" x 8 1/4"	Cake cover	1	2.14 (0.73)	\$ 29.95
DD1220CW	21 1/8" x 14 3/4" x 8"	Dome cover	1	4.2 (1.56)	51.75
DD1220ECW	21 1/8" x 14 3/4" x 8"	Dome w/end cut	1	3.76 (1.54)	65.40
DD1220BECW	21 1/8" x 14 3/4" x 8"	Dome w/2 ends cut	1	3.6 (1.62)	79.65
DD1220SCW	21 1/8" x 14 3/4" x 8"	Dome w/side cut	1	3.8 (1.75)	65.40
DD1826CW	26 3/4" x 18 7/8" x 8 7/8"	Dome cover	1	5.2 (2.73)	72.60
RD926CW	26 3/4" x 10" x 6 1/4"	Rectangular cover	1	3.29 (1.04)	48.20
RD1220CW	21 1/8" x 14 3/4" x 5 5/8"	Rectangular cover	1	4.06 (1.11)	54.75
RD1220CWH	21 1/8" x 14 3/4" x 5"	Rectangular w/hinge	1	4.14 (0.93)	77.90
RD1826CW	26 3/4" x 18 7/8" x 6 1/4"	Rectangular cover	1	6 (1.93)	70.95
RD1826CWH	26 3/4" x 18 3/4" x 5 5/8"	Rectangular w/hinge	1	5.84 (1.58)	82.80
Display Tray – Fits with all 1220 Covers					
DT1220CW	12" x 20"	Tray	1	0.86 (0.29)	20.85
Market Tray – Fits with all 1826 Covers					
1826MT	25 13/16" x 17 13/16" x 1 1/16"	Tray	6	16.58 (0.88)	31.65

* Dimensions include handle(s). Handle height is 13/16".



Display Tray – DT1220CW



Dome with side cut – DD1220SCW

Crocks And Ladles

Crocks

- Ideal for use with salad bars, on buffet tables or at food stations.
- Resists stains and odors caused by vinegar, salad oils, or mayonnaise.
- Made of high impact FDA accepted material.
- Smooth surface is easy-to-clean.

Solid Color Crock Colors:
Cranberry (416), Black (110), Beige (133),
Reddish Brown (195), White (148).
Lid Color: White (148).
Clear Crock Color: Clear (152).

* Lids for Solid Color and Clear Crocks are not interchangeable.



Camwear® Ladles

- Portion control bowls serve the perfect amount of dressing or food ingredient.
- Angled for easy handling.
- Designed with a side rest so ladles don't slip into crocks or serving bowls.
- Made of virtually unbreakable Camwear polycarbonate for years of dependable service.

Colors: Black (110), Beige (133),
Clear (135), White (148),
Reddish Brown (195).

* Cambro's assortment pack offers 8 imprinted ladles and 4 with no imprinting. The 8 imprints include: 1 Thousand Island, 1 French, 1 House, 1 Italian, 1 Bleu Cheese, 1 Ranch, 1 Low Cal, 1 Caesar. This makes a perfect start-up set for a salad bar.

Custom Order Ladle Imprints – See personalization section for information, ordering and pricing. Maximum imprint area is 1" x 1/2". Six dozen minimum.

No broken cartons on assortment pack or imprinted ladles. Special order item not carried in stock, non-returnable.



Imprinted Ladles shown.

CODE	CAPACITY	CASE PACK	CASE LBS. (CUBE)	LIST PRICE EA.
Solid Color Crocks				
CP12	1.2 Quart w/Lid	12	7 (1.07)	\$ 8.25
CP15	1.5 Quart w/Lid	6	4.2 (0.71)	10.25
CP27	2.7 Quart w/Lid	6	6 (1.13)	11.70
Lids For Solid Color Crocks				
CPL12*	Fits Colored CP12 Crock	12	0.8 (0.08)	1.40
CPL27*	Fits Colored CP15 & CP27	12	1.03 (0.13)	1.45
Clear Crocks				
CCP12	1.2 Quart w/Lid	12	8 (1.07)	9.45
CCP15	1.5 Quart w/Lid	6	5 (0.69)	14.80
CCP27	2.7 Quart w/Lid	6	6.25 (1.15)	15.75
Lids For Clear Crocks				
CCPL12*	Fits Clear CCP12 Crock	12	6.16 (0.08)	1.35
CCPL27*	Fits Clear CCP15 & CCP27	12	13.27 (0.13)	1.40

CODE	HEIGHT	TOP DIAMETER	CUT OUT DIAMETER
Solid Color Crock with Lid			
CP12	5 1/16"	5 1/16"	4 3/4"
CP15	4 5/16"	6 3/8"	6 1/16"
CP27	6 3/4"	6 3/8"	6 3/8"
Clear Color Crock with Lid			
CCP12	5 3/8"	5 1/4"	4 7/8"
CCP15	4 3/8"	6 3/4"	6 1/4"
CCP27	6 7/8"	6 3/4"	6 3/16"

InStock Color: Black (110).

CODE	DESCRIPTION	LENGTH	CAPACITY	CASE LBS. (CUBE)	LIST PRICE EA.
LD85	Plain	8 1/2"	3/4 oz.	1 (0.09)	\$ 3.30
LD85A*	Assortment	8 1/2"	3/4 oz.	1 (0.09)	4.75
LD105	Plain	10 1/16"	1 oz.	1.25 (0.13)	3.30
LD105A*	Assortment	10 1/16"	1 oz.	1.25 (0.13)	4.75
LD130	Plain	13"	1 oz.	1.25 (0.11)	3.70

Case Pack: 12 InStock Color: Black (110).

Serving Spoons, Camtensils® & Turners

Camwear® Serving Spoons

- Made of virtually unbreakable polycarbonate, Camwear spoons won't tarnish, bend or dent.
- A wide handle and molded in thumb rest ensures a solid, ergonomic grip.
- Spoons feature a notched back to rest on pans.
- Spoon capacities are approximate and are not intended for measuring.

Colors: Black (110), Beige (133), Clear (135), White (148) Red (404).



Camwear Polycarbonate Serving Spoons



CODE	SP0P10CW	SP0P11CW	SP0P13CW
DESCRIPTION	¾ oz. 10" Perforated Salad Spoon	11" Perforated Deli Spoon	13" Perforated Deli Spoon
DIMENSIONS	10¼" x 1⅛"	11⅞" x 2⅞"	13⅞" x 2⅞"
CASE LBS. (CUBE)	0.65 (0.04)	1 (0.01)	2.22 (0.25)
LIST PRICE EACH	\$ 2.85	\$ 3.50	\$ 6.00

Case Pack: 12

Camwear Solid Serving Spoons



CODE	SP08CW	SP010CW	SP011CW	SP013CW
DESCRIPTION	½ oz. 8" Salad Spoon	¾ oz. 10" Buffet Spoon	11" Deli Spoon	13" Deli Spoon
DIMENSIONS	8⅞" x 1½"	10¼" x 1⅛"	11⅞" x 2⅞"	13⅞" x 2⅞"
CASE LBS. (CUBE)	0.54 (0.03)	0.67 (0.04)	1.50 (0.09)	2.22 (0.26)
LIST PRICE EACH	\$ 2.60	\$ 2.85	\$ 3.50	\$ 6.00

Case Pack: 12 InStock Color: Black (110).



High Heat Camtensils, Spoons and Turners

- Ideal for preparing and serving hot and cold foods.
- Made of a durable high heat material that withstands temperatures from -40°F to 375°F (-40°C to 190°C).
- Handle includes a hole for hanging when not in use and notches to rest on pans.

Colors: Amber (150), Black (110).



High Heat Solid Spoons & Turners



CODE	SP013	SPA14
DESCRIPTION	13" Solid Spoon	14" Solid Turner
DIMENSIONS	13⅞" x 2⅞"	14⅞" x 3½"
CASE LBS. (CUBE)	2.35 (0.25)	7 (0.65)
LIST PRICE EACH	\$ 8.65	\$ 9.70

Case Pack: 12

High Heat Perforated Spoons & Slotted Turners



CODE	SP0P13	SPASL14
DESCRIPTION	13" Perforated Spoon	14" Slotted Turner
DIMENSIONS	13⅞" x 2⅞"	14⅞" x 3½"
CASE LBS. (CUBE)	2.35 (0.26)	3.6 (0.3)
LIST PRICE EACH	\$ 8.65	\$ 9.70

Case Pack: 12



High Heat Spoons and Turners now available in Black.



Lugano® Tongs

- Colored tongs are made from a durable heat resistant material that withstands temperatures up to 300°F (149°C).
- Ideal for serving cold and hot food, even from steam tables.
- Clear tongs are made from virtually unbreakable polycarbonate, which is safe to 210°F (99°C).

Lugano Flat and Scallop Grip Tongs

- Easily grasp hard to hold items such as salad greens and tomatoes.
- Scallop Tongs feature an ergonomic design and secure finger grip.
- Flat Tongs are ribbed to provide a secure hold.

Colors: Black (110), Beige (133), * Clear (135), ** Red (404), White (148).

Two year warranty on colored tongs.

* Clear is safe to 210°F (99°C).
** Red is NSF to 210°F (99°C).



Flat Grip Tongs



CODE	TG6	TG9
LENGTH	6"	9"
CASE LBS. (CUBE)	1 (0.05)	1.64 (0.21)
LIST PRICE EACH	\$ 2.45	\$ 3.90

Case Pack: 12

Scallop Grip Tongs



CODE	6TGS	9TGS	12TGS
LENGTH	6"	9"	12"
CASE LBS. (CUBE)	0.81 (0.07)	1.85 (0.16)	2.5 (0.22)
LIST PRICE EACH	\$ 2.50	\$ 3.90	\$ 5.90

Case Pack: 12 InStock Color: Black (110).

Lugano Angled and Easy-Grasp Tongs

- Angled tongs feature an ergonomic design that makes it easy to serve a variety of foods.
- Easy-Grasp Tongs combine a fork and spoon, providing a secure grip for hard to hold items.

Colors: Black (110), Beige (133), Clear (135), White (148).

Two year warranty on colored tongs.

Easy-Grasp Lugano Tongs are not NSF listed.



Angled Tongs



CODE	TGA8	TGA11
DESCRIPTION	Angled Tong	Angled Tong
DIMENSIONS	8¼"	10 ³ / ₁₆ "
CASE LBS. (CUBE)	2.2 (0.19)	2.86 (0.24)
LIST PRICE EACH	\$ 3.85	\$ 4.50

Case Pack: 12 InStock Color: Black (110).

Easy-Grasp Tongs



CODE	TGG6	TGG9
DESCRIPTION	Easy-Grasp Tong	Easy-Grasp Tong
DIMENSIONS	6"	9½"
CASE LBS. (CUBE)	1.39 (0.16)	2.25 (0.25)
LIST PRICE EACH	\$ 3.85	\$ 4.15

Case Pack: 12 InStock Color: Black (110).



Camwear® Polycarbonate Shakers/Dredges & Condiment Jars

Camwear Shakers/ Dredges

- A staple in the kitchen, at the condiment station or on the dining table.
- Clear virtually unbreakable Camwear polycarbonate and color coded lids make it easy to identify contents.
- Dishwasher safe and unaffected by food acids.

Shaker Color: Clear (135).



96SKRLF
Fine Ground



96SKRLD
Salt & Pepper



96SKRLM
Med. Ground



96SKRLC
Cheese



96SKRLP
Parsley

CODE	COLOR	APPROX. CAPACITY	CASE LBS. (CUBE)	LIST PRICE EA.
Shakers (complete with lids)				
96SKRF (w/fine ground lid)	—	10 oz.	3.09 (0.30)	\$ 5.70
96SKRP (w/parsley lid)	—	10 oz.	3.09 (0.30)	5.70
96SKRD (w/salt & pepper lid)	—	10 oz.	3.09 (0.30)	5.70
96SKRC (w/cheese lid)	—	10 oz.	3.09 (0.30)	5.70
96SKRM (w/medium ground lid)	—	10 oz.	3.10 (0.30)	5.70

InStock Color: Clear (135).

Replacement Lids

96SKRLF fine ground lid	Green (407)	—	0.24 (0.09)	0.95
96SKRLP parsley lid	White (148)	—	1.12 (0.01)	0.95
96SKRLD salt & pepper lid	Beige (406)	—	0.28 (0.05)	0.95
96SKRLC cheese lid	Yellow (405)	—	0.26 (0.05)	0.95
96SKRLM medium ground lid	Rose (408)	—	0.26 (0.07)	0.95

Case Pack: 12

Camwear Condiment Jars

- Use to hold condiments such as mustard, ketchup, dressings, jam or salsa.
- Made of clear, virtually unbreakable Camwear polycarbonate.
- Lids are slotted to hold serving spoons when not in use.

Color: Clear (135).



CODE	APPROX. CAPACITY	SIZE H x D	CASE PACK	CASE LBS. (CUBE)	LIST PRICE EA.
Jar & Cover					
CJ80CW	8 oz.	4" x 3 3/4"	24	0.8 (0.23)	\$ 8.25

* Spoons not included



SHELVING

Camshelving®



Easy and Quick to Clean



Easy to Adjust and Configure

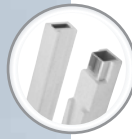

Unquestionably Strong, Durable and Stable



Rust Free

CAMGUARD
ANTIMICROBIAL SHELF PLATES



Store and Transport
Food Safely



COMPONENT

Listed by NSF International, an independent, not-for-profit organization which certifies products that meet their criteria for sanitation and cleanability.



Dishwasher Safe
Except mobile parts



Fit for Food
Products



Cadmium-Free



Recyclable
Polypropylene

Consultant Cut
Sheets and CAD
drawings are
available on
www.cambro.com,
KCL or AutoQuotes

Camshelving is covered by EU Patent #0686817 A2.

Easy And Quick To Clean



- Inhibits the growth of mold, fungus and bacteria.
- Camguard works continuously to suppress the growth of microbes between cleanings.
- All shelf plates are embedded with Camguard antimicrobial so it will not scrape off, wash off or wear out.



For a Sanitary Storage Area

- Shelf plates are easy to remove and run through the dishwasher.
- Smooth polypropylene surface quickly wipes clean.
- Spills clean quickly and easily, reducing the risk of cross-contamination.
- Camshelving® is weldless, so liquids and dirt cannot get inside crevices.

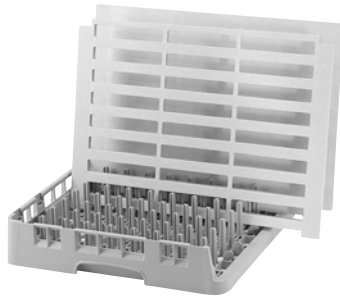

Shelf plates can be placed in an open end Camrack® OETR314 and washed in a commercial dishwasher.

Strong And Durable

Strong as Steel

- Posts and traverses are the weight bearing components, constructed with a steel core and encapsulated by a thick polypropylene outer layer.
- Inner steel core ensures that Camshelving is strong, durable and stable.

- Thick, polypropylene outer layer will not chip, break or corrode.
- Post connectors provide exceptional cross stabilization.

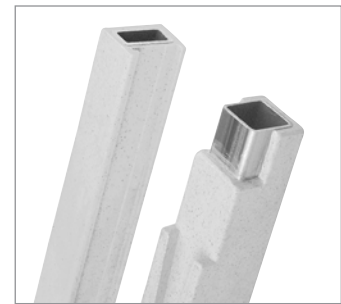

Weight bearing components are made with a steel core.

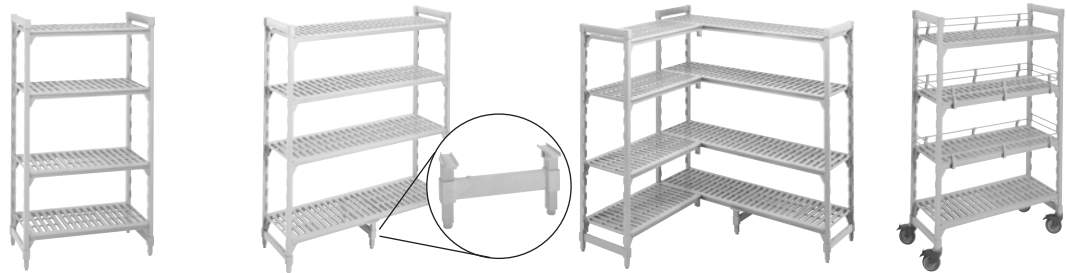

	SINGLE UNIT - 4 Shelves	SINGLE UNIT - 4 Shelves	DUNNAGE STAND	CORNER UNIT (Attached Unit)	MOBILE UNIT
TRAVERSE LENGTH	24" to 48" (610 mm to 1220 mm)	54" to 72" (1380 mm to 1830 mm)	54" to 72" (1380 mm to 1830 mm)	24" to 48" (610 mm to 1220 mm)	24" to 48" (610 mm to 1220 mm)
WEIGHT BEARING CAPACITY PER SHELF	800 lbs. (363 kg)	600 lbs. (272 kg)	1000 lbs. (454 kg)	400 lbs. (181 kg)	—
WEIGHT BEARING CAPACITY PER UNIT	3200 lbs. (1451 kg)	2400 lbs. (1089 kg)	—	1600 lbs. (726 kg)	750 lbs. (340 kg)

Dunnage Stands are used only on the bottom shelf. Recommended for traverses 54" (1380 mm) or longer.

Corner Connectors are recommended for use on traverses 48" (1220 mm) or less.

Due to the weight bearing capacity of casters, maximum weight load on an entire Mobile Camshelving Unit is 750 lbs. (340 kg).

Easy To Assemble & Adjust

Build Any Configuration and Fit Any Size Area

- Create a space efficient layout for any area.
- Assembles in minutes, requiring only the use of a mallet.
- Shelves can be adjusted in 4" (100 mm) increments without disassembling the entire unit.
- Two units can be connected together with shelves at alternating heights for maximum storage flexibility.
- Corner Connectors attach units to create a 90° angle or U shape.

POST HEIGHT	DOVETAIL INCREMENT	NUMBER OF POSITIONS PER POST
Stationary		
32" (820 mm)	4" (100 mm)	6
56" (1430 mm)	4" (100 mm)	12
64" (1630 mm)	4" (100 mm)	14
72" (1830 mm)	4" (100 mm)	16
84" (2140 mm)	4" (100 mm)	19
Mobile		
35" (890 mm)	4" (100 mm)	6
59" (1500 mm)	4" (100 mm)	12
67" (1700 mm)	4" (100 mm)	14
75" (1910 mm)	4" (100 mm)	16

Rust Free

For Use in Any Area, Wet or Dry

- Camshelving is weldless with no exposed metal, so it remains rust free.
- Safe to -36°F (-38°C), making Camshelving the ideal shelving system for freezers, walk-ins or any wet or humid environment.
- Not even salt water or sea air will corrode Camshelving.



Lifetime limited warranty against rust and corrosion for traverses and stationary posts.

EASY TO ADJUST!

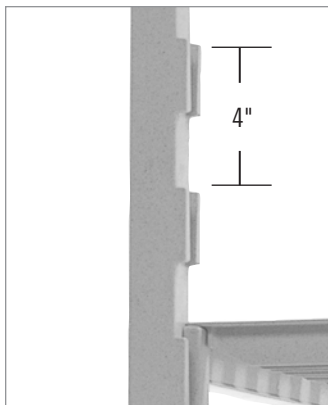

Shelves can be adjusted in 4" (100 mm) increments, without disassembling the unit.

EASY TO ASSEMBLE!



Traverses slide easily down onto dovetail.



Dry Storage Room



Cold Storage Room

Free Camshelving® Consulting



Cambro provides a free consulting service to maximize your storage area. No cost or obligation.

1. Simply provide the dimensions of the storage space, number of shelves per unit, height of the posts, and any additional requirements you have.

2. Cambro will provide a recommended floor plan and product order list.
3. Your Cambro distributor or sales representative will contact you with pricing.

4. To contact the Camshelving Consulting Department please call 1 800 854 7631 and ask the operator to direct you to the Camshelving Consulting department, extensions 4113 or 4189. Or by email; mperez@cambro.com or ldelgado@cambro.com.

Components

Camshelving® is a modular system that allows the flexibility to assemble shelving to fit any size area. The key components, including posts, post connectors, traverses and shelf plates, are available in a variety of

sizes. They can be easily configured to custom build shelving to maximize storage space. Unique design elements such as shared posts and corner connectors simplify assembly and increase storage capacity.

Traverses

Traverses have a steel core with a polypropylene exterior to provide strength and durability.

Traverses connect to the post by sliding on to the dovetail on the post.

Two traverses are needed to build one shelf, and they define the length of the unit.

Shelf Plates

Shelf Plates are made of polypropylene. Dishwasher safe.

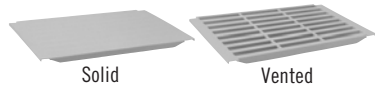

Solid

Vented

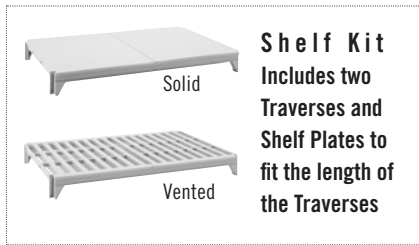

Shelf Kit
Includes two Traverses and Shelf Plates to fit the length of the Traverses

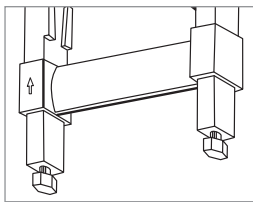

Posts For Stationary Unit

Posts have a steel core with a polypropylene exterior to provide strength and durability.

Posts define the height of the shelving unit and are measured with the leveling foot fully engaged.

Post for Stationary Unit



Stationary Unit

Post Connectors

Post connectors hold two posts together and define the width of the unit.

They are made of polypropylene and provide excellent cross stabilization.

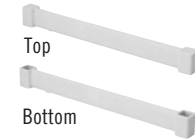

Top

Bottom

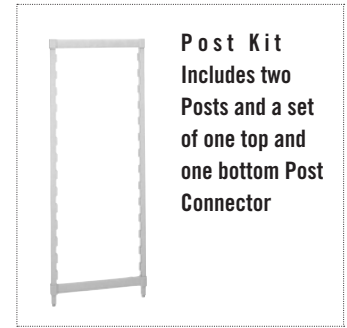

Post Kit
Includes two Posts and a set of one top and one bottom Post Connector

Posts For Mobile Camshelving

Mobile Camshelving posts must be used to build mobile Camshelving units.

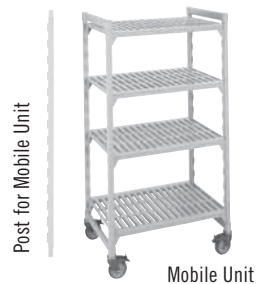

Post for Mobile Unit

Mobile Unit



Casters

Available in standard for dry storage or premium for freezers, cold, or wet applications.

Maximize Space Utilization

Camshelving® is available in starter and add-on units for ease of ordering and assembly.

Starter Units

- Available in stationary or mobile units.
- Starter units ship complete with two post kits, traverses and shelf plates to build an entire unit.

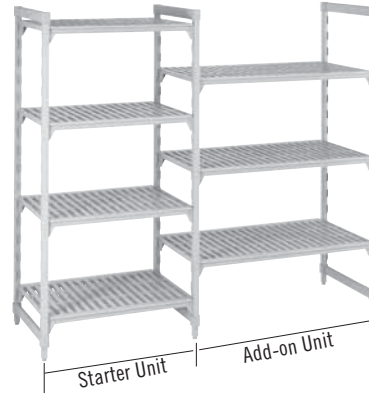

Add-On Units

- Add-On units ship complete with one post kit, traverses and shelf plates to attach to an adjoining unit.
- The traverses on both the first and second unit share the middle post.
- No add-on clips or S-hooks required.
- There is no loss of weight bearing capacity when built in a straight line.

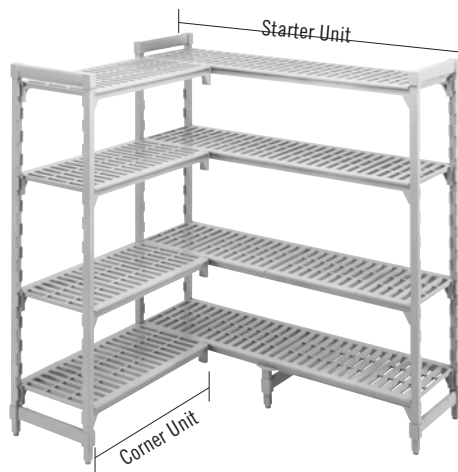

Corner Units & U-Shape Units

- Corner connectors can be used to build corner units and U-Shape units.
- Traverses snap onto corner connectors just like they snap onto the dovetails of the posts.

Corner Connector Set

- Attaches a basic unit to a second unit at a 90° angle or to form a U-shape.
- A set of corner connectors are needed for each shelf.



* Corner connectors are recommended for use on traverses equal to or shorter than 48" (1220 mm), and covered by U.S. Patent D498,664S.

Dunnage Stand

- Increases weight bearing capacity to 1000 lbs. (454 kg) on the bottom shelf.
- Recommended for units 54" (1380 mm) or longer.

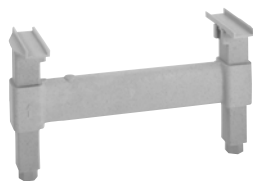

* Dunnage stands are covered by U.S. Patent US 6,981,454B2.

Fence System

- Prevents stored items from falling off shelving units.
- Ideal for mobile shelving.

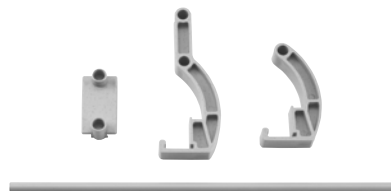

Mobile Units

- Mobile Camshelving units are built by using posts for mobile carts and inserting casters.
- Mobile units are not designed to serve as transport carts.
- Casters sold separately.



Mobile unit shown with optional fencing.

Seismic Foot

- Bolts a post to the floor for a more stable base.



Wall Fastener

- Fastens a unit to a wall as a safety precaution.
- Screws not included.



Identification Tag

- Easily clips onto traverses to identify stored items.
- Made of PVC.
- Includes 12 HACCP labels.



Donut Bumper

- Protects mobile Camshelving.
- 3½" (90 mm) Bumper.



Camshelving® Configuration Details

- The following charts are provided to assist in developing a footprint for your storage area.
- They can also be used to help determine your actual shelf space.
- Traverse measurements are based on outside, or overall unit length.
- This includes the posts.
- The overall length varies slightly when using a basic unit, add-on unit, intermediate unit or corner unit.
- These variations are outlined below.

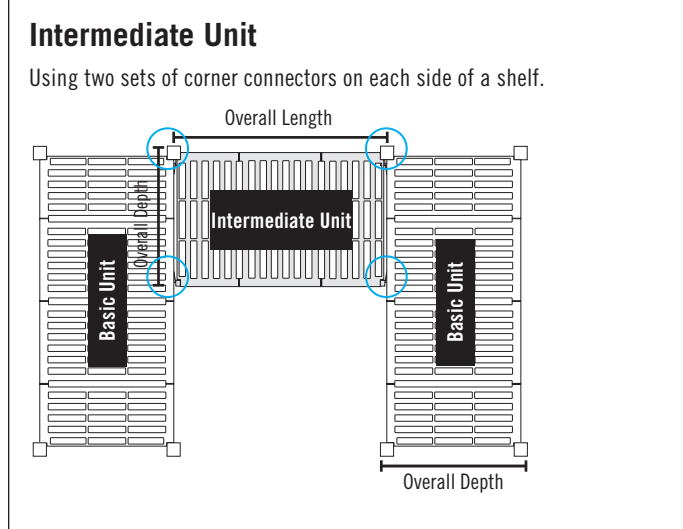
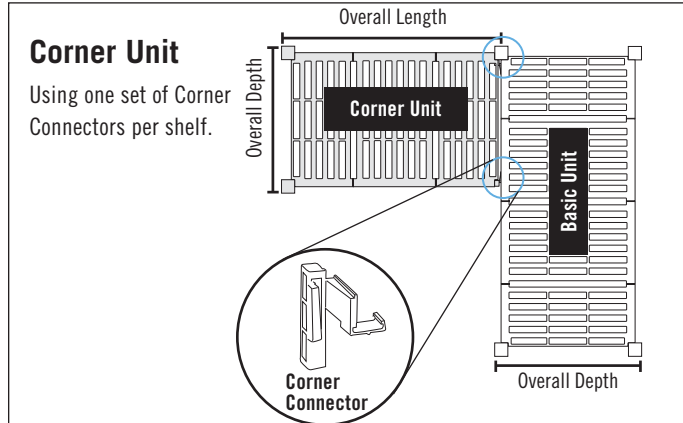
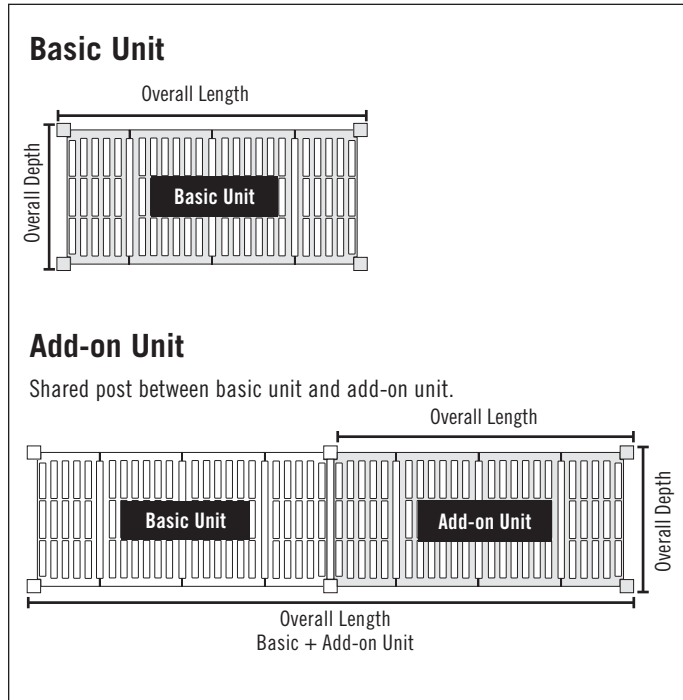

UNIT	BASIC UNIT OVERALL LENGTH	ADD-ON UNIT OVERALL LENGTH	BASIC + ADD-ON UNIT OVERALL LENGTH
24" (610 mm)	24" (610 mm)	22¼" (565 mm)	46¼" (1175 mm)
30" (760 mm)	30" (760 mm)	28¼" (720 mm)	58¼" (1480 mm)
36" (910 mm)	36" (910 mm)	34¼" (870 mm)	70¼" (1780 mm)
42" (1070 mm)	42" (1070 mm)	40¼" (1025 mm)	82¼" (2095 mm)
48" (1220 mm)	48" (1220 mm)	46¼" (1175 mm)	94¼" (2395 mm)
54" (1380 mm)	54" (1380 mm)	52¼" (1330 mm)	106¼" (2710 mm)
60" (1530 mm)	60" (1530 mm)	58¼" (1480 mm)	118¼" (3010 mm)
72" (1830 mm)	72" (1830 mm)	70¼" (1790 mm)	142¼" (3620 mm)

UNIT	CORNER UNIT OVERALL LENGTH	INTERMEDIATE UNIT OVERALL LENGTH
24" (610 mm)	23" (585 mm)	22" (560 mm)
30" (760 mm)	29" (740 mm)	28" (715 mm)
36" (910 mm)	35" (890 mm)	34" (865 mm)
42" (1070 mm)	41" (1045 mm)	40" (1020 mm)
48" (1220 mm)	47" (1195 mm)	46" (1170 mm)

Corner Connectors are recommended for use on traverses 48" (1220 mm) or less.

Shelf Spacing

Dovetails are spaced every 4" (100 mm)

POST HEIGHT	NUMBER OF POSITIONS PER POST	POST HEIGHT	NUMBER OF POSITIONS PER POST
Stationary		Mobile	
32" (820 mm)	6	35" (890 mm)	6
56" (1430 mm)	12	59" (1500 mm)	12
64" (1630 mm)	14	67" (1700 mm)	14
72" (1830 mm)	16	75" (1910 mm)	16
84" (2140 mm)	19		



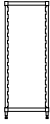
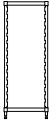
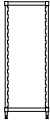

Stationary Post Kits and Accessories

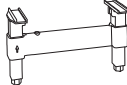
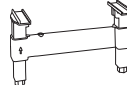
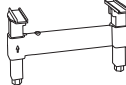
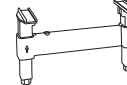
Stationary Post Kits					
HEIGHT	WIDTH	14"	18"	21"	24"
		360 mm	460 mm	540 mm	610 mm
32" 820 mm	CODE	CSPK1432	CSPK1832	CSPK2132	CSPK2432
	CASE LBS. (CUBE)	8.6 (0.30)	8.91 (0.32)	9.2 (0.31)	9.69 (0.3)
	CASE KG (CUBE M ³)	3,9 (0,01)	4,04 (0,01)	4,17 (0,01)	4,4 (0,01)
	LIST PRICE KIT	\$ 69.25	\$ 74.10	\$ 76.90	\$ 77.75
56" 1430 mm	CODE	CSPK1456	CSPK1856	CSPK2156	CSPK2456
	CASE LBS. (CUBE)	13.18 (0.47)	13.49 (0.47)	13.78 (0.47)	14.27 (0.47)
	CASE KG (CUBE M ³)	5,98 (0,01)	6,12 (0,01)	6,25 (0,01)	6,47 (0,01)
	LIST PRICE KIT	\$ 94.60	\$ 99.45	\$ 102.30	\$ 103.10
64" 1630 mm	CODE	CSPK1464	CSPK1864	CSPK2164	CSPK2464
	CASE LBS. (CUBE)	14.77 (0.46)	15.07 (0.46)	15.37 (0.46)	15.86 (0.46)
	CASE KG (CUBE M ³)	6,7 (0,01)	6,84 (0,01)	6,97 (0,01)	7,19 (0,01)
	LIST PRICE KIT	\$ 103.20	\$ 108.05	\$ 110.85	\$ 111.65
72" 1830 mm	CODE	CSPK1472	CSPK1872	CSPK2172	CSPK2472
	CASE LBS. (CUBE)	16.73 (0.52)	17.04 (0.52)	17.33 (0.52)	17.82 (0.52)
	CASE KG (CUBE M ³)	7,59 (0,01)	7,73 (0,01)	7,86 (0,01)	8,08 (0,01)
	LIST PRICE KIT	\$ 105.65	\$ 110.45	\$ 113.10	\$ 114.15
84" 2140 mm	CODE	CSPK1484	CSPK1884	CSPK2184	CSPK2484
	CASE LBS. (CUBE)	19 (0.61)	19.3 (0.61)	19.59 (0.61)	20.08 (0.61)
	CASE KG (CUBE M ³)	8,62 (0,02)	8,75 (0,02)	8,89 (0,02)	9,11 (0,02)
	LIST PRICE KIT	\$ 122.70	\$ 127.65	\$ 130.25	\$ 131.25



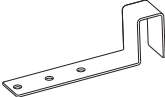





Case Pack: 1 Color: Speckled Gray (480).

Dunnage Stands					
HEIGHT	WIDTH	14"	18"	21"	24"
		360 mm	460 mm	540 mm	610 mm
6 1/2" 165 mm	CODE	CSDS14	CSDS18	CSDS21	CSDS24
	CASE LBS. (CUBE)	2.6 (0.18)	2.9 (0.22)	3.1 (0.26)	3.3 (0.30)
	CASE KG (CUBE M ³)	1,2 (0,0050)	1,3 (0,0062)	1,4 (0,0074)	1,5 (0,0085)
	LIST PRICE KIT	\$ 69.05	\$ 71.30	\$ 73.10	\$ 74.95

Case Pack: 1 Color: Speckled Gray (480).









Accessories						
		Seismic Foot	Wall Fastener	Corner Connectors	Id Tag 6"	Id Tag 3"
	CODE	CSEQ3	CSWF	CSCC	CSID	CSID3
	DESCRIPTION	Seismic Foot	Wall Fastener	90° Left & Right	6" ID Tag	3" ID Tag
	COLOR	Silver	Silver	Speckled Gray (480)	White/Clear	White/Clear
	SIZE: L x W x H	4" x 3 3/4" x 2 3/16" (100 x 85 x 60 mm)	9 7/8" x 1 1/8" x 2 1/8" (238 x 48 x 73 mm)	—	1" x 6" (25 x 150 mm)	1" x 3" (25 x 80 mm)
	CASE LBS. (CUBE)	1.43 (0.04)	4.08 (0.27)	0.38 (0.05)	0.82 (0.08)	0.58 (0.06)
	CASE KG (CUBE M ³)	0,017 (0,011)	1,85 (0,0006)	0,017 (0,014)	0,35 (0,0079)	0,35 (0,0079)
	CASE PACK	4 each	4 each	1 set of 2 parts	12 each	12 each
	LIST PRICE EA.	\$ 33.00	\$ 25.00	\$ 5.40	\$ 2.25	\$ 2.25

Solid Shelf Kits

									
WIDTH	LENGTH	24"	30"	36"	42"	48"	54"	60"	72"
		610 mm	760 mm	910 mm	1070 mm	1220 mm	1380 mm	1530 mm	1830 mm
14" 360 mm	CODE	CS1424SK	CS1430SK	CS1436SK	CS1442SK	CS1448SK	CS1454SK	CS1460SK	CS1472SK
	CASE LBS. (CUBE)	6.9 (1.0)	8.52 (1.0)	10.37 (1.38)	12.54 (1.69)	13.65 (1.39)	15.69 (1.73)	17.34 (2.07)	21.08 (2.50)
	CASE KG (CUBE M ³)	3,13 (0,03)	3,86 (0,03)	4,7 (0,04)	5,69 (0,05)	6,19 (0,04)	7,12 (0,05)	7,87 (0,06)	9,56 (0,07)
	LIST PRICE KIT	\$ 65.20	\$ 80.95	\$ 89.95	\$ 103.60	\$ 114.20	\$ 127.75	\$ 137.80	\$ 161.65
18" 460 mm	CODE	CS1824SK	CS1830SK	CS1836SK	CS1842SK	CS1848SK	CS1854SK	CS1860SK	CS1872SK
	CASE LBS. (CUBE)	7.62 (1.0)	9.39 (1.0)	11.37 (1.38)	13.85 (1.69)	14.93 (1.39)	17.29 (1.73)	19.25 (2.07)	23.28 (2.50)
	CASE KG (CUBE M ³)	3,46 (0,03)	4,26 (0,03)	5,16 (0,04)	6,28 (0,05)	6,77 (0,04)	7,84 (0,05)	8,73 (0,06)	10,56 (0,07)
	LIST PRICE KIT	\$ 68.45	\$ 84.20	\$ 93.60	\$ 112.05	\$ 118.10	\$ 136.60	\$ 149.60	\$ 173.55
21" 540 mm	CODE	CS2124SK	CS2130SK	CS2136SK	CS2142SK	CS2148SK	CS2154SK	CS2160SK	CS2172SK
	CASE LBS. (CUBE)	8.54 (1.0)	10.49 (1.0)	12.79 (1.38)	15.38 (1.69)	16.84 (1.39)	19.31 (1.73)	21.38 (2.07)	25.90 (2.5)
	CASE KG (CUBE M ³)	3,87 (0,03)	4,76 (0,03)	5,8 (0,04)	6,98 (0,05)	7,64 (0,04)	8,76 (0,05)	9,70 (0,06)	11,75 (0,07)
	LIST PRICE KIT	\$ 76.10	\$ 95.25	\$ 106.45	\$ 126.50	\$ 136.10	\$ 156.05	\$ 169.90	\$ 199.15
24" 610 mm	CODE	CS2424SK	CS2430SK	CS2436SK	CS2442SK	CS2448SK	CS2454SK	CS2460SK	CS2472SK
	CASE LBS. (CUBE)	8.85 (1.0)	11.05 (1.0)	13.54 (1.38)	16.26 (1.69)	18.04 (1.39)	20.64 (1.73)	22.84 (2.07)	27.81 (2.50)
	CASE KG (CUBE M ³)	4,01 (0,03)	5,01 (0,03)	6,14 (0,04)	7,38 (0,05)	8,18 (0,04)	9,36 (0,05)	10,36 (0,06)	12,61 (0,07)
	LIST PRICE KIT	\$ 81.00	\$ 100.05	\$ 112.35	\$ 130.05	\$ 142.50	\$ 160.45	\$ 173.95	\$ 203.95





Case Pack: 1 Color: Speckled Gray (480).

Vented Shelf Kits

									
WIDTH	LENGTH	24"	30"	36"	42"	48"	54"	60"	72"
		610 mm	760 mm	910 mm	1070 mm	1220 mm	1380 mm	1530 mm	1830 mm
14" 360 mm	CODE	CS1424VK	CS1430VK	CS1436VK	CS1442VK	CS1448VK	CS1454VK	CS1460VK	CS1472VK
	CASE LBS. (CUBE)	6.73 (1.0)	8.26 (1.0)	10.02 (1.38)	12.12 (1.69)	13.11 (1.39)	15.1 (1.73)	16.68 (2.07)	20.24 (2.5)
	CASE KG (CUBE M ³)	3,05 (0,03)	3,75 (0,03)	4,54 (0,04)	5,50 (0,05)	5,95 (0,04)	6,85 (0,05)	7,57 (0,06)	9,18 (0,07)
	LIST PRICE KIT	\$ 63.60	\$ 79.05	\$ 87.60	\$ 100.30	\$ 111.10	\$ 123.65	\$ 132.65	\$ 155.80
18" 460 mm	CODE	CS1824VK	CS1830VK	CS1836VK	CS1842VK	CS1848VK	CS1854VK	CS1860VK	CS1872VK
	CASE LBS. (CUBE)	7.32 (1.0)	8.98 (1.0)	10.89 (1.38)	13.23 (1.69)	14.27 (1.39)	16.49 (1.73)	18.30 (2.07)	22.14 (2.5)
	CASE KG (CUBE M ³)	3,32 (0,03)	4,07 (0,03)	4,94 (0,04)	6 (0,05)	6,47 (0,04)	7,48 (0,05)	8,3 (0,06)	10,04 (0,07)
	LIST PRICE KIT	\$ 65.25	\$ 80.70	\$ 89.40	\$ 106.70	\$ 112.95	\$ 130.15	\$ 141.95	\$ 165.00
21" 540 mm	CODE	CS2124VK	CS2130VK	CS2136VK	CS2142VK	CS2148VK	CS2154VK	CS2160VK	CS2172VK
	CASE LBS. (CUBE)	7.96 (1.0)	9.78 (1.0)	11.88 (1.38)	14.4 (1.69)	15.61 (1.39)	18.01 (1.73)	20.01 (2.07)	24.21 (2.5)
	CASE KG (CUBE M ³)	3,61 (0,03)	4,44 (0,03)	5,39 (0,04)	6,53 (0,05)	7,08 (0,04)	8,17 (0,05)	9,08 (0,06)	10,98 (0,07)
	LIST PRICE KIT	\$ 73.10	\$ 90.60	\$ 100.95	\$ 120.65	\$ 128.10	\$ 147.70	\$ 161.15	\$ 187.95
24" 610 mm	CODE	CS2424VK	CS2430VK	CS2436VK	CS2442VK	CS2448VK	CS2454VK	CS2460VK	CS2472VK
	CASE LBS. (CUBE)	8.31 (1.0)	10.38 (1.0)	12.70 (1.38)	15.35 (1.69)	16.89 (1.39)	19.43 (1.73)	21.56 (2.07)	26.22 (2.5)
	CASE KG (CUBE M ³)	3,77 (0,03)	4,71 (0,03)	5,76 (0,04)	6,96 (0,05)	7,66 (0,04)	8,81 (0,05)	9,78 (0,06)	11,89 (0,07)
	LIST PRICE KIT	\$ 74.80	\$ 93.10	\$ 104.75	\$ 122.25	\$ 133.85	\$ 150.20	\$ 162.30	\$ 191.15

Case Pack: 1 Color: Speckled Gray (480).

Vented Starter Units 18" Width

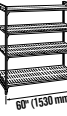



WIDTH 18" 460 mm						
HEIGHT	LENGTH	36"	42"	48"	54"	60"
		910 mm	1070 mm	1220 mm	1380 mm	1530 mm
64" 1630 mm	CODE - 4 SHELVES	CSU48366	CSU48426	CSU48486	CSU48546	CSU48606
	CASE LBS. (CUBE)	72.82 (5.92)	80.24 (5.92)	85.36 (5.92)	92.22 (5.92)	98.92 (5.92)
	CASE KG (CUBE M ³)	33,03 (0,17)	36,4 (0,17)	38,72 (0,17)	41,83 (0,17)	44,87 (0,17)
	LIST PRICE KIT	\$ 573.70	\$ 642.90	\$ 667.90	\$ 736.70	\$ 783.90
64" 1630 mm	CODE - 5 SHELVES	CSU58366	CSU58426	CSU58486	CSU58546	CSU58606
	CASE LBS. (CUBE)	82.36 (5.92)	91.63 (5.92)	98.04 (5.92)	106.61 (5.92)	114.99 (5.92)
	CASE KG (CUBE M ³)	37,36 (0,17)	41,56 (0,17)	44,47 (0,17)	48,36 (0,17)	52,16 (0,17)
	LIST PRICE KIT	\$ 663.10	\$ 749.60	\$ 780.85	\$ 866.85	\$ 925.85
72" 1830 mm	CODE - 4 SHELVES	CSU48367	CSU48427	CSU48487	CSU48547	CSU48607
	CASE LBS. (CUBE)	76.34 (5.92)	83.76 (5.92)	88.89 (5.92)	95.75 (5.92)	102.44 (5.92)
	CASE KG (CUBE M ³)	34,63 (0,17)	37,99 (0,17)	40,32 (0,17)	43,43 (0,17)	46,47 (0,17)
	LIST PRICE KIT	\$ 578.50	\$ 647.70	\$ 672.70	\$ 741.50	\$ 788.70
72" 1830 mm	CODE - 5 SHELVES	CSU58367	CSU58427	CSU58487	CSU58547	CSU58607
	CASE LBS. (CUBE)	88.27 (5.92)	98.28 (5.92)	104.85 (5.92)	110.14 (5.92)	118.51 (5.92)
	CASE KG (CUBE M ³)	40,04 (0,17)	44,58 (0,17)	47,56 (0,17)	49,96 (0,17)	53,75 (0,17)
	LIST PRICE KIT	\$ 667.90	\$ 754.40	\$ 785.65	\$ 871.65	\$ 930.65

Case Pack: 1

Color/InStock Color: Speckled Gray (480).

Dimensions provided with line drawings above are actual dimensions.

Vented Add-On Units





WIDTH 18" 460 mm						
HEIGHT	LENGTH	36"	42"	48"	54"	60"
		910 mm	1070 mm	1220 mm	1380 mm	1530 mm
64" 1630 mm	CODE - 4 SHELVES	CSA48366	CSA48426	CSA48486	CSA48546	CSA48606
	CASE LBS. (CUBE)	58.84 (5.92)	66.26 (5.92)	71.38 (5.92)	78.24 (5.92)	84.94 (5.92)
	CASE KG (CUBE M ³)	26,69 (0,17)	30,05 (0,17)	32,38 (0,17)	35,49 (0,17)	38,53 (0,17)
	LIST PRICE KIT	\$ 465.65	\$ 534.85	\$ 559.85	\$ 628.65	\$ 675.85
64" 1630 mm	CODE - 5 SHELVES	CSA58366	CSA58426	CSA58486	CSA58546	CSA58606
	CASE LBS. (CUBE)	68.38 (5.92)	77.65 (5.92)	84.06 (5.92)	92.63 (5.92)	101.01 (5.92)
	CASE KG (CUBE M ³)	31,02 (0,17)	35,22 (0,17)	38,13 (0,17)	42,02 (0,17)	45,82 (0,17)
	LIST PRICE KIT	\$ 555.05	\$ 641.55	\$ 672.80	\$ 758.80	\$ 817.80
72" 1830 mm	CODE - 4 SHELVES	CSA48367	CSA48427	CSA48487	CSA48547	CSA48607
	CASE LBS. (CUBE)	60.6 (5.92)	68.02 (5.92)	73.15 (5.92)	80 (5.92)	86.7 (5.92)
	CASE KG (CUBE M ³)	27,49 (0,17)	30,85 (0,17)	33,18 (0,17)	36,29 (0,17)	39,33 (0,17)
	LIST PRICE KIT	\$ 468.05	\$ 537.25	\$ 562.25	\$ 631.05	\$ 678.25
72" 1830 mm	CODE - 5 SHELVES	CSA58367	CSA58427	CSA58487	CSA58547	CSA58607
	CASE LBS. (CUBE)	70.14 (5.92)	79.41 (5.92)	85.82 (5.92)	94.4 (5.92)	102.77 (5.92)
	CASE KG (CUBE M ³)	31,81 (0,17)	36,02 (0,17)	38,93 (0,17)	42,82 (0,17)	46,62 (0,17)
	LIST PRICE KIT	\$ 557.45	\$ 643.95	\$ 675.20	\$ 761.20	\$ 820.20

Case Pack: 1

Color/InStock Color: Speckled Gray (480).

Dimensions provided with line drawings above are actual dimensions.

Vented Starter Units 21" Width





WIDTH 21" 540 mm						
HEIGHT	LENGTH	36" 910 mm	42" 1070 mm	48" 1220 mm	54" 1380 mm	60" 1530 mm
64" 1630 mm	CODE - 4 SHELVES	CSU41366	CSU41426	CSU41486	CSU41546	CSU41606
	CASE LBS. (CUBE)	78 (7.39)	86.17 (7.39)	91.95 (7.39)	99.56 (7.39)	107.01 (7.39)
	CASE KG (CUBE M ³)	35,38 (0,21)	39,09 (0,21)	41,71 (0,21)	45,16 (0,21)	48,54 (0,21)
	LIST PRICE KIT	\$ 625.50	\$ 704.30	\$ 734.10	\$ 812.50	\$ 866.30
64" 1630 mm	CODE - 5 SHELVES	CSU51366	CSU51426	CSU51486	CSU51546	CSU51606
	CASE LBS. (CUBE)	88.53 (7.39)	98.74 (7.39)	105.97 (7.39)	115.48 (7.39)	124.79 (7.39)
	CASE KG (CUBE M ³)	40,16 (0,21)	44,79 (0,21)	48,07 (0,21)	52,38 (0,21)	56,60 (0,21)
	LIST PRICE KIT	\$ 726.45	\$ 824.95	\$ 862.20	\$ 960.20	\$ 1,027.45
72" 1830 mm	CODE - 4 SHELVES	CSU41367	CSU41427	CSU41487	CSU41547	CSU41607
	CASE LBS. (CUBE)	81.53 (7.39)	89.7 (7.39)	95.48 (7.39)	103.09 (7.39)	110.54 (7.39)
	CASE KG (CUBE M ³)	36,98 (0,21)	40,69 (0,21)	43,31 (0,21)	46,76 (0,21)	50,14 (0,21)
	LIST PRICE KIT	\$ 630.00	\$ 708.80	\$ 738.60	\$ 817.00	\$ 870.80
72" 1830 mm	CODE - 5 SHELVES	CSU51367	CSU51427	CSU51487	CSU51547	CSU51607
	CASE LBS. (CUBE)	92.06 (7.39)	102.27 (7.39)	109.49 (7.39)	119 (7.39)	128.32 (7.39)
	CASE KG (CUBE M ³)	41,76 (0,21)	46,39 (0,21)	49,66 (0,21)	53,98 (0,21)	58,20 (0,21)
	LIST PRICE KIT	\$ 730.95	\$ 829.45	\$ 866.70	\$ 964.70	\$ 1,031.95

Case Pack: 1

Color/InStock Color: Speckled Gray (480).

Dimensions provided with line drawings above are actual dimensions.

Vented Add-On Units





WIDTH 21" 540 mm						
HEIGHT	LENGTH	36" 910 mm	42" 1070 mm	48" 1220 mm	54" 1380 mm	60" 1530 mm
64" 1630 mm	CODE - 4 SHELVES	CSA41366	CSA41426	CSA41486	CSA41546	CSA41606
	CASE LBS. (CUBE)	63.73 (7.39)	71.9 (7.39)	77.68 (7.39)	85.29 (7.39)	92.74 (7.39)
	CASE KG (CUBE M ³)	28,91 (0,21)	32,61 (0,21)	35,23 (0,21)	38,69 (0,21)	42,07 (0,21)
	LIST PRICE KIT	\$ 514.65	\$ 593.45	\$ 623.25	\$ 701.65	\$ 755.45
64" 1630 mm	CODE - 5 SHELVES	CSA51366	CSA51426	CSA51486	CSA51546	CSA51606
	CASE LBS. (CUBE)	74.26 (7.39)	84.47 (7.39)	91.7 (7.39)	101.21 (7.39)	110.52 (7.39)
	CASE KG (CUBE M ³)	33,68 (0,21)	38,31 (0,21)	41,59 (0,21)	45,91 (0,21)	50,13 (0,21)
	LIST PRICE KIT	\$ 615.60	\$ 714.10	\$ 751.35	\$ 849.35	\$ 916.60
72" 1830 mm	CODE - 4 SHELVES	CSA41367	CSA41427	CSA41487	CSA41547	CSA41607
	CASE LBS. (CUBE)	65.49 (7.39)	73.66 (7.39)	79.44 (7.39)	87.05 (7.39)	94.5 (7.39)
	CASE KG (CUBE M ³)	29,71 (0,21)	33,41 (0,21)	36,03 (0,21)	39,49 (0,21)	42,86 (0,21)
	LIST PRICE KIT	\$ 516.90	\$ 595.70	\$ 625.50	\$ 703.90	\$ 757.70
72" 1830 mm	CODE - 5 SHELVES	CSA51367	CSA51427	CSA51487	CSA51547	CSA51607
	CASE LBS. (CUBE)	76.02 (7.39)	86.23 (7.39)	93.46 (7.39)	102.97 (7.39)	112.28 (7.39)
	CASE KG (CUBE M ³)	34,48 (0,21)	39,11 (0,21)	42,39 (0,21)	46,71 (0,21)	50,93 (0,21)
	LIST PRICE KIT	\$ 617.85	\$ 716.35	\$ 753.60	\$ 851.60	\$ 918.85

Case Pack: 1

Color/InStock Color: Speckled Gray (480).

Dimensions provided with line drawings above are actual dimensions.

Vented Starter Units 24" Width





WIDTH 24" 610 mm						
HEIGHT	LENGTH	36" 910 mm	42" 1070 mm	48" 1220 mm	54" 1380 mm	60" 1530 mm
64" 1630 mm	CODE - 4 SHELVES	CSU44366	CSU44426	CSU44486	CSU44546	CSU44606
	CASE LBS. (CUBE)	83.18 (8.49)	91.88 (8.49)	99.01 (8.49)	107.14 (8.49)	115.12 (9.46)
	CASE KG (CUBE M ³)	37,73 (0,24)	41,68 (0,24)	44,91 (0,24)	48,6 (0,24)	52,22 (0,27)
	LIST PRICE KIT	\$ 642.30	\$ 712.30	\$ 758.70	\$ 824.10	\$ 872.50
64" 1630 mm	CODE - 5 SHELVES	CSU54366	CSU54426	CSU54486	CSU54546	CSU54606
	CASE LBS. (CUBE)	94.53 (8.49)	105.4 (8.49)	114.31 (8.49)	124.48 (8.49)	134.44 (9.46)
	CASE KG (CUBE M ³)	42,88 (0,24)	47,81 (0,24)	51,85 (0,24)	56,46 (0,24)	60,98(0,27)
	LIST PRICE KIT	\$ 747.05	\$ 834.55	\$ 892.55	\$ 974.30	\$ 1,034.80
72" 1830 mm	CODE - 4 SHELVES	CSU44367	CSU44427	CSU44487	CSU44547	CSU44607
	CASE LBS. (CUBE)	86.71 (8.49)	95.4 (8.49)	102.53 (8.49)	110.66 (8.49)	123.76 (9.46)
	CASE KG (CUBE M ³)	39,33 (0,24)	43,27 (0,24)	46,51 (0,24)	50,19 (0,24)	56,14 (0,27)
	LIST PRICE KIT	\$ 647.30	\$ 717.30	\$ 763.70	\$ 829.10	\$ 877.50
72" 1830 mm	CODE - 5 SHELVES	CSU54367	CSU54427	CSU54487	CSU54547	CSU54607
	CASE LBS. (CUBE)	102.29 (8.49)	113.48 (8.49)	123.59 (8.49)	128 (8.49)	144.37 (9.46)
	CASE KG (CUBE M ³)	46,4 (0,24)	51,47 (0,24)	56,06 (0,24)	58,06 (0,24)	65,48 (0,27)
	LIST PRICE KIT	\$ 752.05	\$ 839.55	\$ 897.55	\$ 979.30	\$ 1,039.80

Case Pack: 1

Color: Speckled Gray (480).

Dimensions provided with line drawings above are actual dimensions.

Vented Add-On Units

WIDTH 24" 610 mm						
HEIGHT	LENGTH	36" 910 mm	42" 1070 mm	48" 1220 mm	54" 1380 mm	60" 1530 mm
64" 1630 mm	CODE - 4 SHELVES	CSA44366	CSA44426	CSA44486	CSA44546	CSA44606
	CASE LBS. (CUBE)	68.42 (8.49)	77.12 (8.49)	84.24 (8.49)	92.38 (8.49)	100.35 (9.46)
	CASE KG (CUBE M ³)	31,03 (0,24)	34,98 (0,24)	38,21 (0,24)	41,90 (0,24)	45,52 (0,27)
	LIST PRICE KIT	\$ 530.65	\$ 600.65	\$ 647.05	\$ 712.45	\$ 760.85
64" 1630 mm	CODE - 5 SHELVES	CSA54366	CSA54426	CSA54486	CSA54546	CSA54606
	CASE LBS. (CUBE)	79.77 (8.49)	90.64 (8.49)	99.54 (8.49)	109.71 (8.49)	119.68 (9.46)
	CASE KG (CUBE M ³)	36,18 (0,24)	41,11 (0,24)	45,15 (0,24)	49,76 (0,24)	54,29 (0,27)
	LIST PRICE KIT	\$ 635.40	\$ 722.90	\$ 780.90	\$ 862.65	\$ 923.15
72" 1830 mm	CODE - 4 SHELVES	CSA44367	CSA44427	CSA44487	CSA44547	CSA44607
	CASE LBS. (CUBE)	70.18 (8.49)	78.88 (8.49)	86 (8.49)	94.14 (8.49)	102.11 (9.46)
	CASE KG (CUBE M ³)	31,83 (0,24)	35,78 (0,24)	39,01 (0,24)	42,70 (0,24)	46,32 (0,27)
	LIST PRICE KIT	\$ 533.15	\$ 603.15	\$ 649.55	\$ 714.95	\$ 763.35
72" 1830 mm	CODE - 5 SHELVES	CSA54367	CSA54427	CSA54487	CSA54547	CSA54607
	CASE LBS. (CUBE)	81.53 (8.49)	92.4 (8.49)	101.31 (8.49)	111.47 (8.49)	121.44 (9.46)
	CASE KG (CUBE M ³)	36,98 (0,24)	41,91 (0,24)	45,95 (0,24)	50,56 (0,24)	55,08 (0,27)
	LIST PRICE KIT	\$ 637.90	\$ 725.40	\$ 783.40	\$ 865.15	\$ 925.65

Case Pack: 1

Color: Speckled Gray (480).

Dimensions provided with line drawings above are actual dimensions.

84" Shelving

- 84" (2140 mm) Camshelving® provides maximum storage capacity in limited space.
- Ideal for operations with high product turnover and extensive menu offerings.
- Add a dunnage stand for greater stability and weight bearing capability.





DUE TO THE HEAVY WEIGHT OF 84" (2140 MM) SHELVING, STARTER AND ADD-ON UNITS WILL BE SHIPPED IN MULTIPLE CARTONS.

Starter Units will ship in three separate cartons: two cartons containing one post kit each, and one carton containing five sets of shelf kits.

Add-On Units will ship in two separate cartons: one carton containing one post kit and one carton containing five sets of shelf kits.







Vented Starter Units 24" Width

WIDTH 24" 610 mm						
HEIGHT	LENGTH	36" 910 mm	42" 1070 mm	48" 1220 mm	54" 1380 mm	60" 1530 mm
84" 2140 mm	CODE - 5 SHELVES	CSU54368PKG480	CSU54428PKG480	CSU54488PKG480	CSU54548PKG480	CSU54608PKG480
	POST KIT BOX (2)	2 Post Kits	2 Post Kits	2 Post Kits	2 Post Kits	2 Post Kits
	CASE LBS. (CUBE)	40.16 (1.23)	40.16 (1.23)	40.16 (1.23)	40.16 (1.23)	40.16 (1.23)
	CASE KG (CUBE M³)	18,22 (0,0346)	18,22 (0,0346)	18,22 (0,0346)	18,22 (0,0346)	18,22 (0,0346)
	SHELF KIT BOX (1)	Set of 5 Shelf Kits	Set of 5 Shelf Kits	Set of 5 Shelf Kits	Set of 5 Shelf Kits	Set of 5 Shelf Kits
	CASE LBS. (CUBE)	62.77 (5.28)	73.57 (6.16)	83.1 (7.04)	95.85 (7.92)	104.64 (8.8)
	CASE KG (CUBE M³)	28,47 (0,15)	33,37 (0,174)	37,69 (0,199)	43,48 (0,224)	47,46 (0,249)
LIST PRICE KIT	\$ 786.25	\$ 873.75	\$ 931.75	\$ 1,013.50	\$ 1,074.00	

Case Pack: Three cartons per unit
Shipping weight listed above is per carton.

Color: Speckled Gray (480). Dimensions provided with line drawings above are actual dimensions.

Vented Add-On Units

WIDTH 24" 610 mm						
HEIGHT	LENGTH	36" 910 mm	42" 1070 mm	48" 1220 mm	54" 1380 mm	60" 1530 mm
84" 2140 mm	CODE - 5 SHELVES	CSA54368PKG480	CSA54428PKG480	CSA54488PKG480	CSA54548PKG480	CSA54608PKG480
	POST KIT BOX (1)	1 Post Kit	1 Post Kit	1 Post Kit	1 Post Kit	1 Post Kit
	CASE LBS. (CUBE)	20.08 (0.61)	20.08 (0.61)	20.08 (0.61)	20.08 (0.61)	20.08 (0.61)
	CASE KG (CUBE M³)	9,11 (0,02)	9,11 (0,02)	9,11 (0,02)	9,11 (0,02)	9,11 (0,02)
	SHELF KIT BOX (1)	Set of 5 Shelf Kits	Set of 5 Shelf Kits	Set of 5 Shelf Kits	Set of 5 Shelf Kits	Set of 5 Shelf Kits
	CASE LBS. (CUBE)	62.77 (5.28)	73.57 (6.16)	83.1 (7.04)	95.85 (7.92)	104.64 (8.8)
	CASE KG (CUBE M³)	28,47 (0,15)	33,37 (0,17)	37,69 (0,20)	43,48 (0,22)	47,46 (0,25)
LIST PRICE KIT	\$ 655.00	\$ 742.50	\$ 800.50	\$ 882.25	\$ 942.75	

Case Pack: Two cartons per unit

Color: Speckled Gray (480). Dimensions provided with line drawings above are actual dimensions.



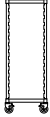
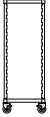
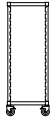



Mobile Post Kits & Casters

Mobile Post Kits Casters are not included and must be ordered separately.				
HEIGHT	WIDTH	18" 460 mm	21" 540 mm	24" 610 mm
35" 890 mm	CODE	CSPRK1835	CSPRK2135	CSPRK2435
	CASE LBS. (CUBE)	7.93 (0.32)	8.23 (0.32)	8.72 (0.32)
	CASE KG (CUBE M³)	3,6 (0,0091)	3,73 (0,0091)	3,96 (0,0091)
	LIST PRICE KIT	\$ 76.60	\$ 79.30	\$ 80.25
59" 1500 mm	CODE	CSPRK1859	CSPRK2159	CSPRK2459
	CASE LBS. (CUBE)	12.93 (0.41)	13.23 (0.41)	13.72 (0.41)
	CASE KG (CUBE M³)	5,86 (0,0116)	6 (0,0116)	6,22 (0,0116)
	LIST PRICE KIT	\$ 103.40	\$ 106.15	\$ 107.00
67" 1700 mm	CODE	CSPRK1867	CSPRK2167	CSPRK2467
	CASE LBS. (CUBE)	14.57 (0.46)	14.86 (0.46)	15.35 (0.46)
	CASE KG (CUBE M³)	6,61 (0,01)	6,74 (0,01)	6,96 (0,01)
	LIST PRICE KIT	\$ 112.40	\$ 115.05	\$ 115.90
75" 1910 mm	CODE	CSPRK1875	CSPRK2175	CSPRK2475
	CASE LBS. (CUBE)	16.43 (0.52)	16.73 (0.52)	17.22 (0.52)
	CASE KG (CUBE M³)	7,45 (0,01)	7,59 (0,01)	7,81 (0,01)
	LIST PRICE KIT	\$ 114.80	\$ 117.50	\$ 118.40

Case Pack: 1

Color: Speckled Gray (480).

Casters are not included and must be ordered separately.

		Premium	Premium	Standard	Standard	Standard	Donut Bumper
Casters							
	DIAMETER	5" 127 mm	5" 127 mm	5" 127 mm	5" 127 mm	5" 127 mm	3½" 90 mm
	CODE	CSCSL	CSCTL	CSSB	CSCS	CSCR	CSRDB
	DESCRIPTION	Swivel Caster	Total Locking Caster	Swivel Chrome with Brake Caster	Swivel Chrome Caster	Rigid Chrome Caster	Donut Bumper
	CASE LBS. (CUBE)	2.16 (0.16)	2.17 (0.16)	2.41 (0.16)	2.22 (0.16)	2.35 (0.16)	0.74 (0.05)
	CASE KG (CUBE M³)	0,98 (0,004)	0,98 (0,004)	1,09 (0,004)	1,01 (0,004)	1,07 (0,004)	0,34 (0,001)
	LIST PRICE EACH	\$ 56.00	\$ 68.00	\$ 45.40	\$ 40.25	\$ 40.25	\$ 9.30







Caster Case Pack: 2

Donut Bumper Case Pack: 4.

PREMIUM CASTERS The premium line is made with a zinc plated post and a non-marking polyurethane wheel. Recommended for use in wet areas or in walk-in refrigerators and freezers.

STANDARD CASTERS The standard casters are chrome plated and can be used for dry storage.

Vented Mobile Starter Units







		Premium	Standard	Premium	Standard	Premium	Standard
WIDTH 18" 460 mm							
HEIGHT (with casters)	LENGTH	36"	36"	42"	42"	48"	48"
		910 mm	910 mm	1070 mm	1070 mm	1220 mm	1220 mm
67" 1700 mm	CODE - 4 SHELVES	CSUR48366	CSURS48366	CSUR48426	CSURS48426	CSUR48486	CSURS48486
	CASE LBS. (CUBE)	80.01 (5.92)	80.62 (5.92)	87.43 (5.92)	88.04 (5.92)	92.56 (5.92)	93.17 (5.92)
	CASE KG (CUBE M³)	36,29 (0,17)	36,57 (0,17)	39,66 (0,17)	39,93 (0,17)	41,98 (0,17)	42,26 (0,17)
	LIST PRICE KIT	\$ 830.40	\$ 753.70	\$ 899.60	\$ 822.90	\$ 924.60	\$ 847.90
67" 1700 mm	CODE - 5 SHELVES	CSUR58366	CSURS58366	CSUR58426	CSURS58426	CSUR58486	CSURS58486
	CASE LBS. (CUBE)	89.55 (5.92)	90.16 (5.92)	98.83 (5.92)	99.43 (5.92)	105.24 (5.92)	105.85 (5.92)
	CASE KG (CUBE M³)	40,62 (0,17)	40,90 (0,17)	44,83 (0,17)	45,10 (0,17)	47,74 (0,17)	48,01 (0,17)
	LIST PRICE KIT	\$ 919.80	\$ 843.10	\$ 1,006.30	\$ 929.60	\$ 1,037.55	\$ 960.85
75" 1910 mm	CODE - 4 SHELVES	CSUR48367	CSURS48367	CSUR48427	CSURS48427	CSUR48487	CSURS48487
	CASE LBS. (CUBE)	83.34 (5.92)	83.95 (5.92)	90.76 (5.92)	91.37 (5.92)	95.89 (5.92)	96.5 (5.92)
	CASE KG (CUBE M³)	37,80 (0,17)	38,08 (0,17)	41,17 (0,17)	41,44 (0,17)	43,49 (0,17)	43,77 (0,17)
	LIST PRICE KIT	\$ 835.20	\$ 758.50	\$ 904.40	\$ 827.70	\$ 929.40	\$ 852.70
75" 1910 mm	CODE - 5 SHELVES	CSUR58367	CSURS58367	CSUR58427	CSURS58427	CSUR58487	CSURS58487
	CASE LBS. (CUBE)	92.89 (5.92)	93.49 (5.92)	102.16 (5.92)	102.77 (5.92)	108.57 (5.92)	109.18 (5.92)
	CASE KG (CUBE M³)	42,13 (0,17)	42,41 (0,17)	46,34 (0,17)	46,62 (0,17)	49,25 (0,17)	49,52 (0,17)
	LIST PRICE KIT	\$ 924.60	\$ 847.90	\$ 1,011.10	\$ 934.40	\$ 1,042.35	\$ 965.65

Case Pack: 1







Color: Speckled Gray (480).

Premium Casters: include two non-corrosive swivel locking casters (CSCSL) and two total locking casters (CSCTL).

Standard Casters: include two swivel chrome casters (CSCS) and two swivel chrome with brakes (CSSB).

		Premium	Standard	Premium	Standard	Premium	Standard
WIDTH 21" 540 mm							
HEIGHT (with casters)	LENGTH	36"	36"	42"	42"	48"	48"
		910 mm	910 mm	1070 mm	1070 mm	1220 mm	1220 mm
67" 1700 mm	CODE - 4 SHELVES	CSUR41366	CSURS41366	CSUR41426	CSURS41426	CSUR41486	CSURS41486
	CASE LBS. (CUBE)	85.2 (7.39)	85.81 (7.39)	93.37 (7.39)	93.98 (7.39)	99.15 (7.39)	99.75 (7.39)
	CASE KG (CUBE M³)	38,65 (0,21)	38,92 (0,21)	42,35 (0,21)	42,63 (0,21)	44,97 (0,21)	45,25 (0,21)
	LIST PRICE KIT	\$ 881.90	\$ 805.20	\$ 960.70	\$ 884.00	\$ 990.50	\$ 913.80
67" 1700 mm	CODE - 5 SHELVES	CSUR51366	CSURS51366	CSUR51426	CSURS51426	CSUR51486	CSURS51486
	CASE LBS. (CUBE)	95.73 (7.39)	96.33 (7.39)	105.94 (7.39)	106.55 (7.39)	113.16 (7.39)	113.77 (7.39)
	CASE KG (CUBE M³)	43,42 (0,21)	43,99 (0,21)	48,05 (0,21)	48,33 (0,21)	51,33 (0,21)	51,60 (0,21)
	LIST PRICE KIT	\$ 982.85	\$ 906.15	\$ 1,081.35	\$ 1,004.65	\$ 1,118.60	\$ 1,041.90
75" 1910 mm	CODE - 4 SHELVES	CSUR41367	CSURS41367	CSUR41427	CSURS41427	CSUR41487	CSURS41487
	CASE LBS. (CUBE)	88.53 (7.39)	89.14 (7.39)	96.7 (7.39)	97.31 (7.39)	102.48 (7.39)	103.09 (7.39)
	CASE KG (CUBE M³)	40,16 (0,21)	40,43 (0,21)	43,86 (0,21)	44,14 (0,21)	46,48 (0,21)	46,76 (0,21)
	LIST PRICE KIT	\$ 886.80	\$ 810.10	\$ 965.60	\$ 888.90	\$ 995.40	\$ 918.70
75" 1910 mm	CODE - 5 SHELVES	CSUR51367	CSURS51367	CSUR51427	CSURS51427	CSUR51487	CSURS51487
	CASE LBS. (CUBE)	99.06 (7.39)	99.67 (7.39)	109.27 (7.39)	109.88 (7.39)	116.5 (7.39)	117.1 (7.39)
	CASE KG (CUBE M³)	44,93 (0,21)	45,21 (0,21)	49,56 (0,21)	49,84 (0,21)	52,84 (0,21)	53,12 (0,21)
	LIST PRICE KIT	\$ 987.75	\$ 911.05	\$ 1,086.25	\$ 1,009.55	\$ 1,123.50	\$ 1,046.80

Vented Mobile Starter Units

		Premium	Standard	Premium	Standard	Premium	Standard
WIDTH 24" 610 mm							
HEIGHT (with casters)	LENGTH	36" 910 mm	36" 910 mm	42" 1070 mm	42" 1070 mm	48" 1220 mm	48" 1220 mm
67" 1700 mm	CODE - 4 SHELVES	CSUR44366	CSURS44366	CSUR44426	CSURS44426	CSUR44486	CSURS44486
	CASE LBS. (CUBE)	90.38 (8.49)	90.99 (8.49)	99.07 (8.49)	99.68 (8.49)	106.2 (8.49)	106.81 (8.49)
	CASE KG (CUBE M³)	41 (0,24)	41,27 (0,24)	44,94 (0,24)	45,21 (0,24)	48,17 (0,24)	48,45 (0,24)
	LIST PRICE KIT	\$ 898.80	\$ 821.90	\$ 968.80	\$ 891.90	\$ 1,015.20	\$ 938.30
67" 1700 mm	CODE - 5 SHELVES	CSUR54366	CSURS54366	CSUR54426	CSURS54426	CSUR54486	CSURS54486
	CASE LBS. (CUBE)	101.72 (8.49)	102.33 (8.49)	112.59 (8.49)	113.2 (8.49)	121.5 (8.49)	122.11 (8.49)
	CASE KG (CUBE M³)	46,14 (0,24)	46,42 (0,24)	51,07 (0,24)	51,35 (0,24)	55,11 (0,24)	55,39 (0,24)
	LIST PRICE KIT	\$ 1,003.55	\$ 926.65	\$ 1,091.05	\$ 1,014.15	\$ 1,149.05	\$ 1,072.15
75" 1910 mm	CODE - 4 SHELVES	CSUR44367	CSURS44367	CSUR44427	CSURS44427	CSUR44487	CSURS44487
	CASE LBS. (CUBE)	93.71 (8.49)	94.32 (8.49)	106.06 (8.49)	103.01 (8.49)	109.53 (8.49)	110.14 (8.49)
	CASE KG (CUBE M³)	42,51 (0,24)	42,78 (0,24)	48,11 (0,24)	46,72 (0,24)	49,68 (0,24)	49,96 (0,24)
	LIST PRICE KIT	\$ 903.80	\$ 827.10	\$ 973.80	\$ 897.10	\$ 1,020.20	\$ 943.50
75" 1910 mm	CODE - 5 SHELVES	CSUR54367	CSURS54367	CSUR54427	CSURS54427	CSUR54487	CSURS54487
	CASE LBS. (CUBE)	105.06 (8.49)	105.66 (8.49)	115.93 (8.49)	116.53 (8.49)	124.83 (8.49)	125.44 (8.49)
	CASE KG (CUBE M³)	47,65 (0,24)	47,93 (0,24)	52,58 (0,24)	52,86 (0,24)	56,62 (0,24)	56,9 (0,24)
	LIST PRICE KIT	\$ 1,008.55	\$ 931.85	\$ 1,096.05	\$ 1,019.35	\$ 1,154.05	\$ 1,077.35



Case Pack: 1

Color: Speckled Gray (480).

Premium Casters: include two non-corrosive swivel locking casters (CSCSL) and two total locking casters (CSCTL).

Standard Casters: include two swivel chrome casters (CSCS) and two swivel chrome with brakes (CSSB).

Fence System

PRODUCT	FITS	24"	30"	36"	42"	48"	54"	60"	72"
	Traverse	610 mm	760 mm	910 mm	1070 mm	1220 mm	1380 mm	1530 mm	1830 mm
Double Level Traverse Fence 4" (10 cm) 	CODE	CSFT242	CSFT302	CSFT362	CSFT422	CSFT482	CSFT542	CSFT602	CSFT722
	# OF BRACKETS	2	2	2	3	4	4	4	5
	# OF RODS	2	2	2	2	2	2	2	2
	CASE LBS. (CUBE)	1.94 (0.23)	2.06 (0.30)	2.17 (0.37)	2.31 (0.43)	2.43 (0.50)	2.56 (0.57)	2.68 (0.64)	2.93 (0.77)
	CASE KG (CUBE M³)	3,53 (0,0235)	4,36 (0,0235)	5,19 (0,0235)	6,03 (0,0274)	6,85 (0,0300)	7,68 (0,035)	18,30 (0,039)	10,07 (0,047)
	LIST PRICE KIT	\$ 26.10	\$ 28.70	\$ 31.35	\$ 34.95	\$ 37.65	\$ 41.20	\$ 43.80	\$ 50.10
Single Level Traverse Fence 2" (5 cm) 	CODE	CSFT241	CSFT301	CSFT361	CSFT421	CSFT481	CSFT541	CSFT601	CSFT721
	# OF BRACKETS	2	2	2	3	3	4	4	5
	# OF RODS	1	1	1	1	1	1	1	1
	CASE LBS. (CUBE)	1.74 (0.13)	1.80 (0.17)	1.86 (0.21)	1.91 (0.25)	1.99 (0.29)	2.07 (0.33)	2.13 (0.37)	2.27 (0.45)
	CASE KG (CUBE M³)	3,78 (0,0235)	4,63 (0,0235)	5,47 (0,0235)	6,53 (0,0274)	7,16 (0,03)	8,22 (0,0351)	9,05 (0,039)	10,84 (0,047)
	LIST PRICE KIT	\$ 19.80	\$ 21.10	\$ 22.40	\$ 23.80	\$ 25.85	\$ 27.90	\$ 29.20	\$ 32.60

PRODUCT	FITS	14"	18"	21"	24"
	Post Connector	360 mm	460 mm	540 mm	610 mm
End Fence 	CODE	CSFE14	CSFE18	CSFE21	CSFE24
	# OF BRACKETS	2	2	2	2
	# OF RODS	2	2	2	2
	CASE LBS. (CUBE)	1.73 (0.03)	1.81 (0.05)	1.87 (0.06)	1.93 (0.07)
	CASE KG (CUBE M³)	3,53 (0,0235)	4,36 (0,0235)	5,19 (0,0235)	6,03 (0,0274)
	LIST PRICE KIT	\$ 19.75	\$ 21.35	\$ 22.55	\$ 23.80

Case Pack: 1

Color: Speckled Gray (480).

Camshelving® High Density Storage System

High Density Camshelving maximizes storage capacity by eliminating aisles and utilizing all available space. Ideal for operations with limited space or that need to use their space more effectively. Floor track system provides safe and easy access to stored product. Heavy weight loads roll securely on raised floor track.



*Increases
Storage Capacity
up to **40%***

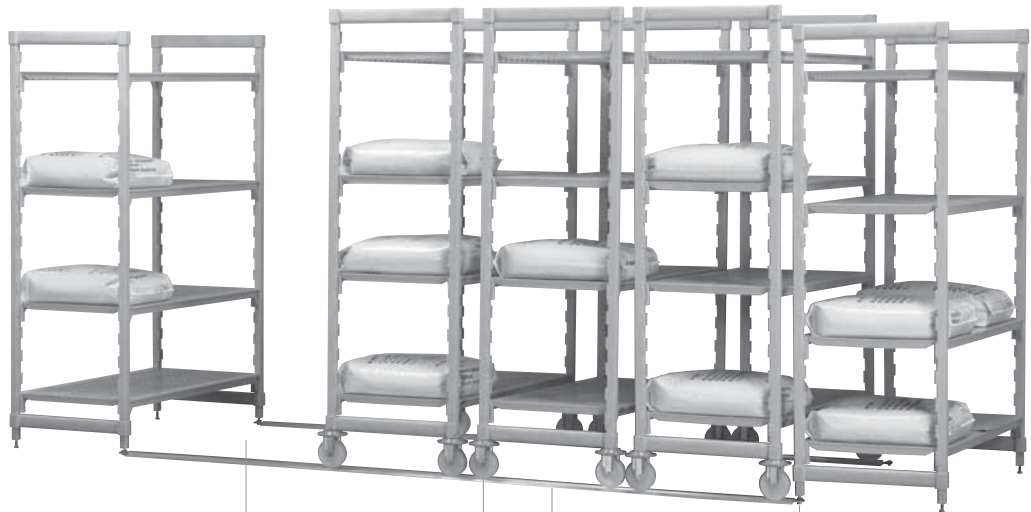

Easy to Clean

- Camshelving is the most hygienic high density storage system available.
- Raised track ensures dirt will not get trapped, and is easy to clean.
- Aluminum track and stainless steel hardware are rust resistant.
- Shelf plates easily wipe clean or can be removed and run through the dishwasher.

Ergonomic Access to Stored Product

Active aisle of 30"-36" provides easy access to all stored product. Low profile sloped rail design ensures easy access to product using the active aisle.



Roll Easily and Securely

Grooved casters roll easily and securely on raised track. Can be used on any surface, including tile and choppy floors.

Raised Track

Raised track provides a smooth and level surface to easily roll mobile units. It ensures dirt will not get trapped, and is easy to clean. Mobile Units with heavy weight loads roll smoothly on track.

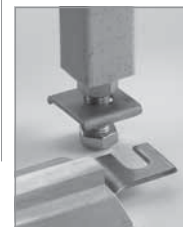

Easy Glide Floor Tracks

The track simply connects to the bottom of the Stationary Camshelving Unit. No bolts or drilling into the floor are required.

Camshelving® High Density Storage System

Easy to Order

- Camshelving stationary units act as the system anchor.
- Mobile units with exclusive high density casters are available with vented or solid shelves.
- Mobile units can be ordered in convenient starter units, or custom built using Camshelving mobile post kits, shelf kits and high density casters.*

- Raised track kits ship with all hardware necessary for installation.
- * Refer to pages 64 and 69 for components to build custom size mobile Camshelving units.

Easy to Configure and Assemble

1. Determine your room size and needs. Multiple track kits can be used together to build the desired length of track.**
2. Choose starter unit size. Existing Camshelving stationary units can be retrofitted and utilized as the system anchors.
3. Select high density mobile units. Choose either starter units, or build custom size units from components.
4. Different width stationary and mobile units may be used in a single run of track.

** It is recommended to use a stationary unit for every 15' of track to further stabilize the system.

System Components

- A Stationary Units
- B Mobile Units
- C Track
- D Active Aisle

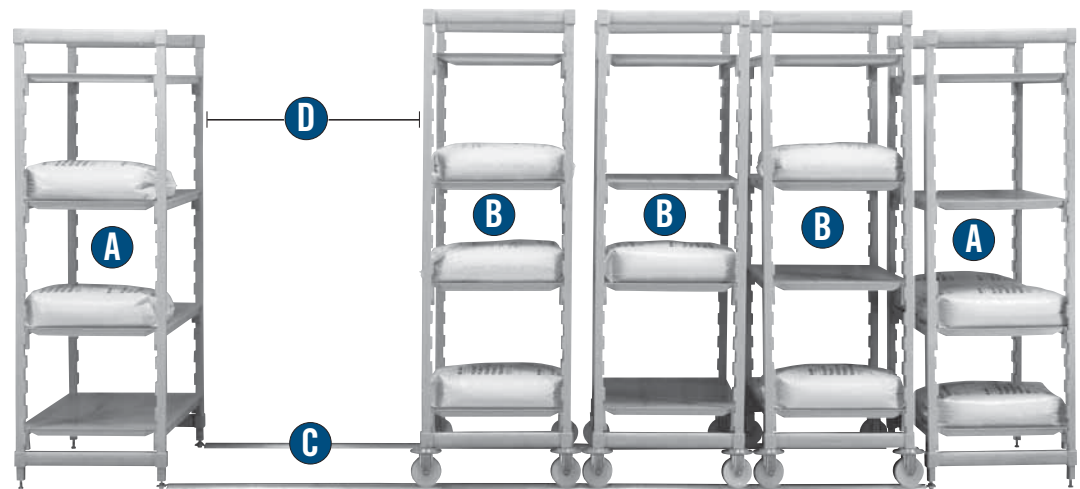

High Density Mobile Units include 4 High Density Casters.

Weight bearing capacity of High Density Mobile Camshelving Units is 750 lbs. (340 kg).

It is recommended to use Fencing with High Density Camshelving. Refer to page 71 for product details.

All necessary hardware is included in the track kit.

CODE	DESCRIPTION	SIZE	CASE PACK	CASE LBS. (CUBE)	LIST PRICE EA.
Track Kits					
CSHDTK10	10' Track Kit for 3 Mobile Units*	120"	1	23.4 (0.34)	\$ 620.00
CSHDTK12	12' Track Kit for 4 Mobile Units*	144"	1	27.2 (0.40)	715.00
CSHDTK145	14.5' Track Kit for 5 Mobile Units*	174"	1	32.3 (0.6)	805.00
High Density Mobile Starter Units with Vented Shelves					
CSUHD44486	Mobile Unit 4 Vented Shelves	24" x 48" x 67"	1	105.66 (8.49)	926.70
CSUHD44487	Mobile Unit 4 Vented Shelves	24" x 48" x 75"	1	108.99 (8.49)	931.70
CSUHD44427	Mobile Unit 4 Vented Shelves	24" x 42" x 75"	1	101.87 (8.49)	885.30
CSUHD44367	Mobile Unit 4 Vented Shelves	24" x 36" x 75"	1	93.17 (8.49)	815.30
High Density Mobile Starter Units with Solid Shelves					
CSUHD44486S	Mobile Unit 4 Solid Shelves	24" x 48" x 67"	1	110.27 (8.49)	961.30
CSUHD44487S	Mobile Unit 4 Solid Shelves	24" x 48" x 75"	1	113.6 (8.49)	966.30
CSUHD44427S	Mobile Unit 4 Solid Shelves	24" x 42" x 75"	1	115.52 (8.49)	916.50
CSUHD44367S	Mobile Unit 4 Solid Shelves	24" x 36" x 75"	1	96.56 (8.49)	845.70
Accessories					
CSHDDB	High Density Donut Bumper		4	2.01 (0.05)	10.70
CSHDC	High Density Caster		2	4.10 (0.16)	42.00

Color: Speckled Gray (480) **Track Kits Color:** (000)

* Track holds up to 24" wide mobile units.

Security Cage For Camshelving®

- Provides safe storage for valuables such as steaks, seafood, wine, champagne and spirits.
- Stainless steel material is safe for use in coolers and freezers.
- Ideal for securing personal items such as purses and backpacks.
- Unique modular design provides the flexibility to retrofit one shelf at a time or an entire shelving unit.



Fits on US Standard Camshelving and Elements Series Units 24" (61 cm) wide, 48" (122 cm) in length and longer.



Ideal for use in coolers and freezers.

CODE	DIMENSIONS W x L x H	CASE LBS. (CUBE)	LIST PRICE EA.
CSSC2448	25¼" x 42½" x 18" (64 x 108 x 46 cm)	31½ (5.73)	\$ 640.00

Case Pack: 1 Padlock not included.

Divider Bar for Camshelving®

- Creates a custom storage unit that can accommodate a variety of storage products and sizes on a single Camshelving unit.
- Angled and straight designs hold food pans and boxes straight or on an angle for more ergonomic reach.
- Divider bars fit on 24" (610 mm) wide Camshelving units and hold up to 200 lbs. (91 kg) per shelf.
- Divider bars feature a raised bar on the front edge to keep racks and pans from sliding off the front of the unit.



Camracks® fit on divider bars to create a warewashing drying and storage station.



Divider bars can accommodate any size food pans from GN 1/1 to GN 1/9.



12" x 18" food boxes with sliding lids can be used with divider bars for hygienic food storage.

CODE	DESCRIPTION	CASE LBS. (CUBE)	LIST PRICE EA.
CSDBA	Divider Bar Angled	1.9 (0.096)	\$ 5.50
CSDBS	Divider Bar Straight	1.9 (0.096)	5.50

Case Pack: 4 Color: Speckled Gray (480).

Tray Slide Rack for Camshelving®

- Holds six 18" x 26" sheet pans.
- Made from Aluminum which is safe for use in coolers and freezers.
- Fits on Camshelving and Camshelving Elements Series Units 24" wide and 24" in length or longer.



CODE	DIMENSIONS D x L x H	CASE LBS. (CUBE)	LIST PRICE EA.
CSTSR	23" x 20¾" x 20"	15 (5.65)	\$ 287.00

Case Pack: 1 InStock Color: (000).

Camshelving® Wall Shelves And Storesafe® Shelf Extenders

Wall Shelves

- Expand storage space in kitchens, above work stations and sinks.
- Features virtually indestructible I-beam supports that hold up to 150 lbs. (68 kg) per shelf.
- Durable polypropylene withstands temperatures up to 190°F (88°C), and will not rust or corrode.
- Snap fit rail design allows shelves to snap on and off for easy cleaning.
- 2" (5 cm) backsplash and marine front edge controls spills and cross contamination.

Shelf Extenders

- Convert empty wall space into a functional storage area.
- Use with or without Camshelving Wall Shelves.
- Peg strips withstand temperatures up to 190°F (88°C), and will not rust or corrode.

Wall Shelf Color: Speckled Gray (480).

Extender Peg Strip Color: Black (110).

Wall Shelf Kits are covered by the following U.S. Patents D 508,646S & D 512,867 S.



Shelf Extenders ship in one carton with all hardware and includes:

LENGTH	PEG STRIPS	BRACKETS	HOOKS
36"	3	2	6
48"	3	3	9



CODE	CSWS1436SK	CSWS1448SK	CSWS1436VK	CSWS1448VK
DESCRIPTION	36" x 14" Wall Shelf, Solid	48" x 14" Wall Shelf, Solid	36" x 14" Wall Shelf, Vented	48" x 14" Wall Shelf, Vented
EXTERIOR DIMENSIONS	L 36" x W 14" x H 13½"	L 48" x W 14" x H 13½"	L 36" x W 14" x H 13½"	L 48" x W 14" x H 13½"
CASE LBS. (CUBE)	10 (1.31)	12.50 (1.73)	9.75 (1.31)	11.50 (1.73)
LIST PRICE EACH	\$ 145.15	\$ 166.65	\$ 145.15	\$ 166.65

Case Pack: 1

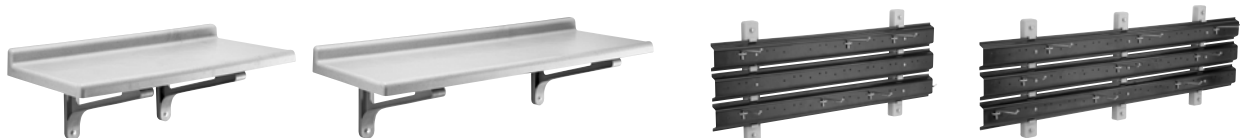

CODE	CSWS1836SK	CSWS1848SK	CSWS36EK	CSWS48EK
DESCRIPTION	36" x 18" Wall Shelf, Solid	48" x 18" Wall Shelf, Solid	36" Shelf Extender	48" Shelf Extender
EXTERIOR DIMENSIONS	L 36" x W 18" x H 13½"	L 48" x W 18" x H 13½"	L 35½" x W 2" x H 15½"	L 47½" x W 2" x H 15½"
CASE LBS. (CUBE)	11.77 (1.54)	14.45 (2.05)	6 (0.37)	8.25 (0.49)
LIST PRICE EACH	\$ 166.65	\$ 182.75	\$ 205.00	\$ 305.00

Case Pack: 1

Camshelving®

ELEMENTS SERIES



The Future of Shelving



Strong as Steel

State-of-the-art, composite material is as strong as steel.



Lifetime Warranty

Lifetime warranty against rust and corrosion, ideal for use in cold, hot, wet and dry environments.



Easy To Clean

Dishwasher safe, removable shelf plates are embedded with Camguard® antimicrobial protection.



Camshelving® Elements Series

STRONG TECHNOLOGY



- Composite material is as strong as steel.
- 78" (1980 mm) stationary traverse is the longest and strongest in the industry; supports loads up to 600 lbs. (272 kg) per shelf.
- 60% lighter in weight than steel; easy to set up, adjust and change configurations.
- Resistant to moisture; won't rust or corrode.

HYGIENIC DESIGN



- Non-porous surface simply wipes clean.
- Shelf plates are easily removed for thorough dishwasher cleaning.
- Camguard® Antimicrobial protection is permanently embedded in shelf plates.
- Camguard works continuously to suppress the growth of microbes between cleanings.

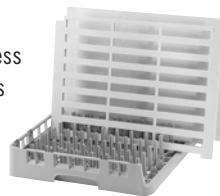

SHELVING FOR LIFE



- Lifetime warranty against corrosion and rust.
- Withstands temperatures as cold as -36°F (-38°C) or warm environments up to 190°F (88°C).
- Ideal for wet, dry, cold or humid environments.
- Impervious to moisture and chemicals.
- Won't peel, dent or warp; corrosion resistant.

Weight Capacity

	TRAVERSE LENGTH	WEIGHT BEARING CAPACITY	
		PER SHELF	PER UNIT
Single Unit (4 shelves)	30"- 48"	800 lbs.	3200 lbs.
	760 mm - 1220 mm	363 kg	1451 kg
Single Unit (4 shelves)	54"- 78"	600 lbs.	2400 lbs.
	1380 mm - 1530 mm	272 kg	1089 kg
Dunnage Stand	54"- 78" 1380 mm - 1980 mm	1000 lbs.	—
		454 kg bottom shelf only	
Corner Unit (4 shelves)	36"- 48"	400 lbs.	1600 lbs.
	910 mm - 1220 mm	180 kg	720 kg
Mobile Unit (4 shelves)	36"- 60" 910 mm - 1530 mm	—	900 lbs.
		—	409 kg

Dunnage Stands are recommended for units 54" (1380 mm) or longer.

Corner Connectors are recommended for use on traverses 48" (1220 mm) or less.

Due to the weight bearing capacity of casters, maximum weight load on an entire Mobile Elements unit is 900 lbs. (409 kg).



Camshelving® Elements Series Stationary Traverse Dovetails are covered by Patent # D 623,929. Camshelving® Elements Series Stationary Traverse Corner Connectors are covered by Patent # D 624,764. Other Camshelving® Elements Series Components are Patent Pending.

Maximize Space Utilization

Elements is available in partially assembled starter and add-on units for ease of ordering and assembly.

4-Shelf Stationary Starter Units

- Ship complete in one box with two post kits, 8 stationary traverses, 32 stationary dovetails and shelf plates to build one entire unit.



Dunnage Stand

- Increases weight bearing capacity to 1000 lbs. (454 kg) on the bottom shelf.
- Recommended for units 54" (1380 mm) or longer.

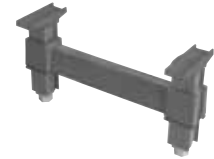

4-Shelf Add-On Units

- Ship complete in one box with one post kit, 8 traverses, 32 dovetails and shelf plates to attach to an adjoining unit.
- The traverses on both units share the middle posts, maximizing space.
- No add-on clips or S-hooks required.
- No loss of weight bearing capacity when built in a straight line.



Seismic Foot

- Bolts a post to the floor for a more stable base.
- Screws not included.



Corner Units & U-Shape Units

- Corner connectors can be used to build Corner and U-Shaped units.
- Corner connectors easily snap onto traverses.
- Corner connector set attaches a starter unit to a second unit at a 90° angle or to form a U-shape.
- A set of corner connectors are needed for each shelf.



Corner connectors are recommended for use on traverses equal to or shorter than 48" (1220 mm), and are covered by U.S. Patent D624,764.

Wall Fastener

- Fastens a unit to a wall as a safety precaution.
- Screws not included.



Identification Tag

- Easily clips onto traverses to identify stored items.
- Made of PVC.
- Includes 12 HACCP labels.



4-Shelf Mobile Starter Units

- Mobile starter units ship complete in one box with 2 post kits, 8 mobile traverses, 32 mobile dovetails, shelf plates and 4 casters.
- Mobile traverses feature a 45° gusset for maximum cross-stabilization.
- Available with standard or premium casters.
- Mobile units are not designed to serve as transport carts.
- Mobile traverses and mobile dovetails are required to build a Mobile Elements Series Unit.



Donut Bumper

- Protects posts and casters.
- 5" (127 mm) Bumper.



Camshelving® Elements Series Configuration Details

- The following charts are provided to assist in developing a footprint for your storage area.
- They can also be used to help determine your actual shelf space.
- Shelf measurements are based on outside, or overall unit length & width including the posts.
- The overall length varies slightly when using an add-on, intermediate or corner unit.
- These variations are outlined below.

Shelf Spacing

Notches for dovetails are spaced every 4" (100 mm).

POST HEIGHT	NUMBER OF POSITIONS PER POST	POST HEIGHT WITH CASTER	NUMBER OF POSITIONS PER POST
Stationary		Mobile	
64" (1630 mm)	14	70" (1778 mm)	14
72" (1830 mm)	16	78" (1980 mm)	16
84" (2140 mm)	19		

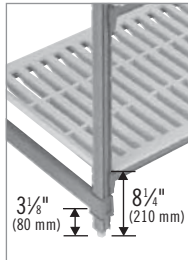

Easy To Adjust

Build Any Configuration and Fit Any Size Area

- Create a space efficient layout for any area.
- Assembles requiring only the use of a rubber mallet.
- Shelves can be adjusted in 4" (100 mm) increments without disassembling the entire unit.
- Two units can be connected together by sharing posts with shelves at alternating heights for maximum storage flexibility.
- Corner Connectors attach units to create a 90° angle or U-shape.

POST HEIGHT	DOVETAIL INCREMENT	NUMBER OF POSITIONS PER POST
Stationary		
64" (1630 mm)	4" (100 mm)	14
72" (1830 mm)	4" (100 mm)	16
84" (2140 mm)	4" (100 mm)	19
Mobile		
70" (1778 mm)	4" (100 mm)	14
78" (1980 mm)	4" (100 mm)	16

Shelving Consulting

Cambro provides a free consulting service to maximize your storage area. No cost or obligation.

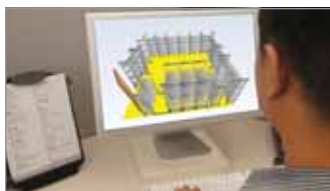

1. Simply provide the dimensions of the storage space, number of shelves per unit, height of the posts, and any additional requirements you have.
2. Cambro will provide a recommended floor plan, 3-D view and product order list in Excel.
3. Your Cambro distributor or sales representative will contact you with pricing.
4. To contact the Camshelving Consulting Department please call 1 800 854 7631 and ask the operator to direct you to the Camshelving Consulting department, extensions 4113 or 4189. Or by email; mperez@cambro.com or ldelgado@cambro.com.

Starter Unit

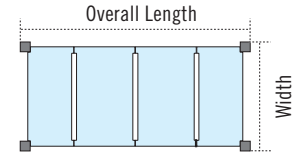

Add-on Unit

Shared posts between starter unit and add-on unit maximize space.

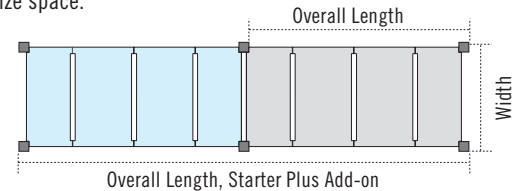

Corner Unit

Using one set of Corner Connectors per shelf.

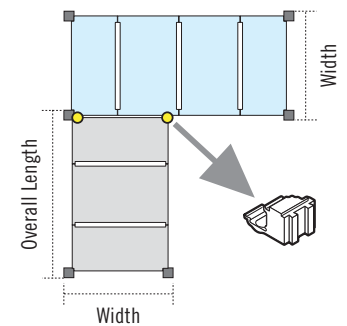

U-Shaped Unit

Requires two sets of corner connectors per shelf.

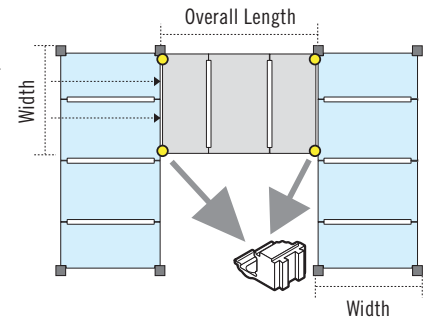

UNIT	CORNER UNIT OVERALL LENGTH	INTERMEDIATE UNIT OVERALL LENGTH
30" (760 mm)	29" (740 mm)	28" (715 mm)
36" (910 mm)	35" (890 mm)	34" (865 mm)
42" (1070 mm)	41" (1045 mm)	40" (1020 mm)
48" (1220 mm)	47" (1195 mm)	46" (1170 mm)

Corner Connectors are recommended for use on traverses 48" (1220 mm) or less.

UNIT	STARTER UNIT OVERALL LENGTH	ADD-ON UNIT OVERALL LENGTH	STARTER + ADD-ON UNIT OVERALL LENGTH
30" (760 mm)	30" (760 mm)	28 1/4" (720 mm)	58 1/4" (1480 mm)
36" (910 mm)	36" (910 mm)	34 1/4" (870 mm)	70 1/4" (1780 mm)
42" (1070 mm)	42" (1070 mm)	40 1/4" (1025 mm)	82 1/4" (2095 mm)
48" (1220 mm)	48" (1220 mm)	46 1/4" (1175 mm)	94 1/4" (2395 mm)
54" (1380 mm)	54" (1380 mm)	52 1/4" (1330 mm)	106 1/4" (2710 mm)
60" (1530 mm)	60" (1530 mm)	58 1/4" (1480 mm)	118 1/4" (3010 mm)
72" (1830 mm)	72" (1830 mm)	70 1/4" (1790 mm)	142 1/4" (3620 mm)
78" (1980 mm)	78" (1980 mm)	76 1/4" (1940 mm)	154 1/4" (3920 mm)



Stationary Post Kits

Camshelving®
Elements Series

HEIGHT 64" 1630 mm	WIDTH	14"	18"	21"	24"
		360 mm	460 mm	540 mm	610 mm
72" 1830 mm	CODE	EPK1464	EPK1864	EPK2164	EPK2464
	CASE LBS. (CUBE)	8.43 (0.46)	8.66 (0.46)	8.84 (0.46)	9.02 (0.46)
	CASE KG (CUBE M³)	3,82 (0,01)	3,93 (0,01)	4,01 (0,01)	4,09 (0,01)
	LIST PRICE KIT	\$ 77.70	\$ 81.30	\$ 83.40	\$ 84.05
84" 2140 mm	CODE	EPK1472	EPK1872	EPK2172	EPK2472
	CASE LBS. (CUBE)	9.27 (0.52)	9.50 (0.52)	9.68 (0.52)	9.86 (0.52)
	CASE KG (CUBE M³)	4,20 (0,01)	4,31 (0,01)	4,39 (0,01)	4,47 (0,01)
	LIST PRICE KIT	\$ 79.45	\$ 83.15	\$ 85.15	\$ 85.90
84" 2140 mm	CODE	EPK1484	EPK1884	EPK2184	EPK2484
	CASE LBS. (CUBE)	10.49 (0.61)	10.72 (0.61)	10.90 (0.61)	11.08 (0.61)
	CASE KG (CUBE M³)	4,76 (0,02)	4,86 (0,02)	4,94 (0,02)	5,02 (0,02)
	LIST PRICE KIT	\$ 92.35	\$ 96.10	\$ 98.05	\$ 98.80

Includes 2 stationary posts with leveling feet installed, 1 top post connector, 1 bottom post connector, 8 post connector wedges in a bag and instructions.
Case Pack: 1 Color: Brushed Graphite (580).

Optional Accessories

Dunnage Stands

HEIGHT 6 1/2" 165 mm	WIDTH	14"	18"	21"	24"
		360 mm	460 mm	540 mm	610 mm
6 1/2" 165 mm	CODE	EDS14	EDS18	EDS21	EDS24
	CASE LBS. (CUBE)	1.94 (0.18)	2.06 (0.22)	2.14 (0.26)	2.23 (0.30)
	CASE KG (CUBE M³)	0,88 (0,001)	0,93 (0,006)	0,97 (0,007)	1,01 (0,008)
	LIST PRICE KIT	\$ 49.50	\$ 51.10	\$ 52.45	\$ 53.70

Case Pack: 1 Color: Brushed Graphite (580).

Accessories

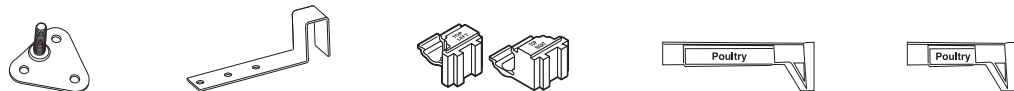

DESCRIPTION	Seismic Foot	Wall Fastener	90° Left & Right Corner Connectors	ID Tag 6"	ID Tag 3"
CODE	CSEQ3	CSWF	ECC	CSID	CSID3
COLOR	Silver	Silver	Brushed Graphite (580)	White/Clear	White/Clear
CASE LBS. (CUBE)	1.43 (0.04)	4.08 (0.27)	0.70 (0.04)	0.82 (0.28)	0.58 (0.28)
CASE KG (CUBE M³)	0,62 (0,011)	1,85 (0,006)	0,32 (0,001)	0,37 (0,01)	0,35 (0,01)
CASE PACK	4 each	4 each	1 set	12 each	12 each
LIST PRICE EACH	\$ 33.00	\$ 25.00	\$ 5.80	\$ 2.25	\$ 2.25

Solid Single Shelf Kits for Stationary Units

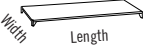
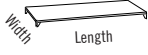

Camshelving®
Elements Series

	LENGTH	30"	36"	42"	48"
		760 mm	910 mm	1070 mm	1220 mm
WIDTH 14" 360 mm	CODE	ESK1430S	ESK1436S	ESK1442S	ESK1448S
	CASE LBS. (CUBE)	6.68 (0.96)	8.23 (1.51)	9.77 (2.03)	10.50 (1.54)
	CASE KG (CUBE M³)	3,03 (0,03)	3,73 (0,04)	4,43 (0,06)	4,76 (0,04)
	LIST PRICE KIT	\$ 60.25	\$ 69.65	\$ 80.20	\$ 88.45
18" 460 mm	CODE	ESK1830S	ESK1836S	ESK1842S	ESK1848S
	CASE LBS. (CUBE)	7.55 (0.96)	9.23 (1.51)	11.09 (2.03)	11.78 (1.54)
	CASE KG (CUBE M³)	3,42 (0,03)	4,19 (0,04)	5,03 (0,06)	5,34 (0,04)
	LIST PRICE KIT	\$ 61.95	\$ 72.45	\$ 86.75	\$ 91.35
21" 540 mm	CODE	ESK2130S	ESK2136S	ESK2142S	ESK2148S
	CASE LBS. (CUBE)	8.38 (0.96)	10.65 (1.51)	12.61 (2.03)	13.70 (1.54)
	CASE KG (CUBE M³)	3,80 (0,03)	4,83 (0,04)	5,72 (0,06)	6,21 (0,04)
	LIST PRICE KIT	\$ 70.40	\$ 82.45	\$ 97.90	\$ 105.35
24" 610 mm	CODE	ESK2430S	ESK2436S	ESK2442S	ESK2448S
	CASE LBS. (CUBE)	9.13 (0.96)	11.40 (1.51)	13.50 (2.03)	14.90 (1.54)
	CASE KG (CUBE M³)	4,14 (0,03)	5,17 (0,04)	6,12 (0,06)	6,76 (0,04)
	LIST PRICE KIT	\$ 75.10	\$ 86.95	\$ 100.70	\$ 110.30
	LENGTH	54"	60"	72"	78"
		1380 mm	1530 mm	1830 mm	1980 mm CAMBRO Exclusive
WIDTH 14" 360 mm	CODE	ESK1454S	ESK1460S	ESK1472S	ESK1478S
	CASE LBS. (CUBE)	12.15 (2.49)	13.66 (2.77)	15.79 (3.31)	16.73 (3.60)
	CASE KG (CUBE M³)	5,51 (0,07)	6,20 (0,08)	7,16 (0,09)	7,59 (0,10)
	LIST PRICE KIT	\$ 98.90	\$ 106.65	\$ 125.15	\$ 134.35
18" 460 mm	CODE	ESK1854S	ESK1860S	ESK1872S	ESK1878S
	CASE LBS. (CUBE)	13.74 (2.49)	15.58 (2.77)	17.98 (3.31)	18.92 (3.60)
	CASE KG (CUBE M³)	6,23 (0,07)	7,07 (0,08)	8,16 (0,09)	8,58 (0,10)
	LIST PRICE KIT	\$ 105.75	\$ 115.80	\$ 134.35	\$ 143.70
21" 540 mm	CODE	ESK2154S	ESK2160S	ESK2172S	ESK2178S
	CASE LBS. (CUBE)	15.77 (2.49)	17.70 (2.77)	20.61 (3.31)	21.55 (3.60)
	CASE KG (CUBE M³)	7,15 (0,07)	8,03 (0,08)	9,35 (0,09)	9,78 (0,10)
	LIST PRICE KIT	\$ 120.80	\$ 131.55	\$ 154.15	\$ 165.40
24" 610 mm	CODE	ESK2454S	ESK2460S	ESK2472S	ESK2478S
	CASE LBS. (CUBE)	17.10 (2.49)	19.16 (2.77)	22.51 (3.31)	23.45 (3.60)
	CASE KG (CUBE M³)	7,75 (0,07)	8,69 (0,08)	10,21 (0,09)	10,64 (0,10)
	LIST PRICE KIT	\$ 124.20	\$ 134.65	\$ 157.85	\$ 169.50

Includes solid shelf plates for 1 shelf, 2 stationary traverses, 1 bag of 8 stationary traverse dovetails (4 each A and B) and instructions.
Case Pack: 1 **Color:** Brushed Graphite (580).

Vented Single and 4-Shelf Kits for Stationary Units

Camshelving®
Elements Series

	LENGTH	30"	36"	42"	48"
		760 mm	910 mm	1070 mm	1220 mm
14" A 360 mm	CODE	ESK1430V	ESK1436V	ESK1442V	ESK1448V
	CASE LBS. (CUBE)	6.41 (0.96)	7.88 (1.51)	9.36 (2.03)	9.97 (1.54)
	CASE KG (CUBE M³)	2.91 (0,03)	3,57 (0,04)	4,24 (0,06)	4,52 (0,04)
	LIST PRICE KIT	\$ 59.05	\$ 67.85	\$ 77.65	\$ 86.00
18" A 460 mm	CODE	ESK1830V	ESK1836V	ESK1842V	ESK1848V
	CASE LBS. (CUBE)	7.14 (0.96)	8.75 (1.51)	10.46 (2.03)	11.12 (1.54)
	CASE KG (CUBE M³)	3,24 (0,03)	3,97 (0,04)	4,75 (0,06)	5,05 (0,04)
	LIST PRICE KIT	\$ 59.35	\$ 69.20	\$ 82.60	\$ 87.45
21" A 540 mm	CODE	ESK2130V	ESK2136V	ESK2142V	ESK2148V
	CASE LBS. (CUBE)	7.65 (0.96)	9.74 (1.51)	11.64 (2.03)	12.46 (1.54)
	CASE KG (CUBE M³)	3,47 (0,03)	4,42 (0,04)	5,28 (0,06)	5,65 (0,04)
	LIST PRICE KIT	\$ 66.75	\$ 78.20	\$ 93.35	\$ 99.15
24" A 610 mm	CODE	ESK2430V	ESK2436V	ESK2442V	ESK2448V
	CASE LBS. (CUBE)	8.48 (0.96)	10.55 (1.51)	12.58 (2.03)	13.75 (1.54)
	CASE KG (CUBE M³)	3,85 (0,03)	4,79 (0,04)	5,70 (0,06)	6,24 (0,04)
	LIST PRICE KIT	\$ 71.15	\$ 81.10	\$ 94.65	\$ 103.55
18" B 460 mm	CODE	—	ESK1836V4	—	ESK1848V4
	CASE LBS. (CUBE)		32.10 (3.75)		41.04 (4.31)
	CASE KG (CUBE M³)		14,57 (0,11)		18,63 (0,12)
	LIST PRICE KIT		\$ 276.80		\$ 349.80
24" B 610 mm	CODE	—	ESK2436V4	—	ESK2448V4
	CASE LBS. (CUBE)		39.31 (3.75)		51.53 (4.31)
	CASE KG (CUBE M³)		17,85 (0,11)		23,39 (0,12)
	LIST PRICE KIT		\$ 324.40		\$ 414.20
	LENGTH	54"	60"	72"	78" CAMBRO Exclusive
		1380 mm	1530 mm	1830 mm	1980 mm
14" A 360 mm	CODE	ESK1454V	ESK1460V	ESK1472V	ESK1478V
	CASE LBS. (CUBE)	11.55 (2.49)	13.01 (2.77)	14.95 (3.31)	15.89 (3.60)
	CASE KG (CUBE M³)	5,24 (0,07)	5,90 (0,08)	6,78 (0,09)	7,21 (0,10)
	LIST PRICE KIT	\$ 95.75	\$ 102.70	\$ 120.55	\$ 129.50
18" A 460 mm	CODE	ESK1854V	ESK1860V	ESK1872V	ESK1878V
	CASE LBS. (CUBE)	12.94 (2.49)	14.62 (2.77)	16.85 (3.31)	17.79 (3.60)
	CASE KG (CUBE M³)	5,87 (0,07)	6,63 (0,08)	7,64 (0,09)	8,07 (0,10)
	LIST PRICE KIT	\$ 100.75	\$ 109.90	\$ 127.75	\$ 136.75
21" A 540 mm	CODE	ESK2154V	ESK2160V	ESK2172V	ESK2178V
	CASE LBS. (CUBE)	14.46 (2.49)	16.34 (2.77)	18.91 (3.31)	19.85 (3.60)
	CASE KG (CUBE M³)	6,56 (0,07)	7,41 (0,08)	8,58 (0,09)	9,00 (0,10)
	LIST PRICE KIT	\$ 114.35	\$ 124.75	\$ 145.50	\$ 155.90
24" A 610 mm	CODE	ESK2454V	ESK2460V	ESK2472V	ESK2478V
	CASE LBS. (CUBE)	15.88 (2.49)	17.88 (2.77)	20.93 (3.31)	21.87 (3.60)
	CASE KG (CUBE M³)	7,20 (0,07)	8,11 (0,08)	9,49 (0,09)	9,92 (0,10)
	LIST PRICE KIT	\$ 116.25	\$ 125.65	\$ 147.95	\$ 159.20
18" B 460 mm	CODE	—	ESK1860V4	—	—
	CASE LBS. (CUBE)		51.36 (5.84)		
	CASE KG (CUBE M³)		23,32 (0,16)		
	LIST PRICE KIT		\$ 439.60		
24" B 610 mm	CODE	—	ESK2460V4	—	—
	CASE LBS. (CUBE)		64.40 (5.84)		
	CASE KG (CUBE M³)		29,24 (0,16)		
	LIST PRICE KIT		\$ 502.60		

A - SINGLE SHELF - Includes vented shelf plates for 1 shelf, 2 stationary traverses, 1 bag of 8 stationary traverse dovetails (4 each A and B) and instructions.
 B - FOUR SHELVES - Includes vented shelf plates for 4 shelves, 8 stationary traverses, 1 bag of 32 stationary traverse dovetails (16 each A and B) and instructions.
 Case Pack: 1 Color: Brushed Graphite (580).

Vented 4-Shelf Stationary Starter Units 18" Width (460 mm)

Camshelving®
Elements Series

 HEIGHT 64" 1630 mm	LENGTH	36"	42"	48"	54"	60"
		910 mm	1070 mm	1220 mm	1380 mm	1530 mm
64" 1630 mm	CODE	ESU183664	ESU184264	ESU184864	ESU185464	ESU186064
	CASE LBS. (CUBE)	49.99 (5.92)	54.53 (5.92)	58.94 (5.92)	63.64 (5.92)	68.26 (5.92)
	CASE KG (CUBE M³)	22.68 (0,17)	24,74 (0,17)	26,74 (0,17)	28,87 (0,17)	30,96 (0,17)
	LIST PRICE KIT	\$ 439.40	\$ 493.00	\$ 512.40	\$ 565.60	\$ 602.20
72" 1830 mm	CODE	ESU183672	ESU184272	ESU184872	ESU185472	ESU186072
	CASE LBS. (CUBE)	51.27 (5.92)	55.81 (5.92)	60.22 (5.92)	64.92 (5.92)	69.54 (5.92)
	CASE KG (CUBE M³)	23,26 (0,17)	25,32 (0,17)	27,32 (0,17)	29,45 (0,17)	31,54 (0,17)
	LIST PRICE KIT	\$ 443.10	\$ 496.70	\$ 516.10	\$ 569.30	\$ 605.90

Includes 4 stationary posts with leveling feet installed - pre-assembled with post connectors and wedges,
1 bag of 32 stationary traverse dovetails (16 A and 16 B), vented shelf plates (for 4 shelves), 8 stationary traverses and instructions.
Case Pack: 1 Color: Brushed Graphite (580).

Vented 4-Shelf Stationary Starter Units 21" Width (540 mm)

 HEIGHT 64" 1630 mm	LENGTH	36"	42"	48"	54"	60"
		910 mm	1070 mm	1220 mm	1380 mm	1530 mm
64" 1630 mm	CODE	ESU213664	ESU214264	ESU214864	ESU215464	ESU216064
	CASE LBS. (CUBE)	54.94 (7.39)	60.23 (7.39)	65.28 (7.39)	70.74 (7.39)	76.11 (7.39)
	CASE KG (CUBE M³)	24,92 (0,21)	27,32 (0,21)	29,61 (0,21)	32,09 (0,21)	34,52 (0,21)
	LIST PRICE KIT	\$ 479.60	\$ 540.20	\$ 563.40	\$ 624.20	\$ 665.80
72" 1830 mm	CODE	ESU213672	ESU214272	ESU214872	ESU215472	ESU216072
	CASE LBS. (CUBE)	56.22 (7.39)	61.51 (7.39)	66.57 (7.39)	72.02 (7.39)	77.39 (7.39)
	CASE KG (CUBE M³)	25,50 (0,21)	27,90 (0,21)	30,20 (0,21)	32,67 (0,21)	35,10 (0,21)
	LIST PRICE KIT	\$ 483.10	\$ 543.70	\$ 566.90	\$ 627.70	\$ 669.30

Includes 4 stationary posts with leveling feet installed - pre-assembled with post connectors and wedges,
1 bag of 32 stationary traverse dovetails (16 A and 16 B), vented shelf plates (for 4 shelves), 8 stationary traverses and instructions.
Case Pack: 1 Color: Brushed Graphite (580).

Vented 4-Shelf Stationary Starter Units 24" Width (610 mm)

 HEIGHT 64" 1630 mm	LENGTH	36"	42"	48"	54"	60"
		910 mm	1070 mm	1220 mm	1380 mm	1530 mm
64" 1630 mm	CODE	ESU243664	ESU244264	ESU244864	ESU245464	ESU246064
	CASE LBS. (CUBE)	59.50 (8.49)	61.66 (8.49)	71.72 (8.49)	77.70 (8.49)	83.59 (8.49)
	CASE KG (CUBE M³)	26,99 (0,24)	27,97 (0,24)	32,53 (0,24)	35,24 (0,24)	37,92 (0,24)
	LIST PRICE KIT	\$ 492.50	\$ 546.70	\$ 582.30	\$ 633.10	\$ 670.70
72" 1830 mm	CODE	ESU243672	ESU244272	ESU244872	ESU245472	ESU246072
	CASE LBS. (CUBE)	60.78 (8.49)	66.59 (8.49)	72.99 (8.49)	79.98 (8.49)	84.87 (8.49)
	CASE KG (CUBE M³)	27,57 (0,24)	30,21 (0,24)	33,11 (0,24)	35,82 (0,24)	38,50 (0,24)
	LIST PRICE KIT	\$ 496.20	\$ 550.40	\$ 586.00	\$ 636.80	\$ 674.40
* 84" 2140 mm	CODE	ESU243684PKG	ESU244284PKG	ESU244884PKG	ESU245484PKG	ESU246084PKG
	CASE LBS. (CUBE)	61.46 (14.30)	67.27 (15.57)	73.68 (12.57)	80.66 (14.59)	86.55 (15.14)
	CASE KG (CUBE M³)	27,88 (0,14)	30,51 (0,17)	33,42 (0,16)	36,58 (0,2)	39,26 (0,2)
	LIST PRICE KIT	\$ 522.00	\$ 576.20	\$ 611.80	\$ 662.60	\$ 700.20

Includes 4 stationary posts with leveling feet installed - pre-assembled with post connectors and wedges,
1 bag of 32 stationary traverse dovetails (16 A and 16 B), vented shelf plates (for 4 shelves), 8 stationary traverses and instructions.
Case Pack: 1 Color: Brushed Graphite (580).

* Due to the size of 84" (2140 mm) shelving, starter units ship in 3 cartons.

Vented 4-Shelf Stationary Add-On Units 18" Width (460 mm)

Camshelving®
Elements Series

HEIGHT 64" 1630 mm	LENGTH	36"	42"	48"	54"	60"
		910 mm	1070 mm	1220 mm	1380 mm	1530 mm
72" 1830 mm	CODE	EA183664	EA184264	EA184864	EA185464	EA186064
	CASE LBS. (CUBE)	42.35 (5.92)	46.88 (5.92)	51.30 (5.92)	55.99 (5.92)	60.61 (5.92)
	CASE KG (CUBE M³)	19,21 (0,17)	21,27 (0,17)	23,27 (0,17)	25,40 (0,17)	27,49 (0,17)
	LIST PRICE KIT	\$ 358.10	\$ 411.70	\$ 431.10	\$ 484.30	\$ 520.90
72" 1830 mm	CODE	EA183672	EA184272	EA184872	EA185472	EA186072
	CASE LBS. (CUBE)	42.99 (5.92)	47.53 (5.92)	51.94 (5.92)	56.64 (5.92)	61.25 (5.92)
	CASE KG (CUBE M³)	19,50 (0,17)	21,56 (0,17)	23,56 (0,17)	25,69 (0,17)	27,78 (0,17)
	LIST PRICE KIT	\$ 359.95	\$ 413.55	\$ 432.95	\$ 486.15	\$ 522.75

Includes 2 stationary posts with leveling feet installed - pre-assembled with post connectors and wedges,
1 bag of 32 stationary traverse dovetails (16 A and 16 B), vented shelf plates (for 4 shelves), 8 stationary traverses and instructions.
Case Pack: 1 Color: Brushed Graphite (580).

Vented 4-Shelf Stationary Add-On Units 21" Width (540 mm)

HEIGHT 64" 1630 mm	LENGTH	36"	42"	48"	54"	60"
		910 mm	1070 mm	1220 mm	1380 mm	1530 mm
64" 1630 mm	CODE	EA213664	EA214264	EA214864	EA215464	EA216064
	CASE LBS. (CUBE)	47.13 (7.39)	52.41 (7.39)	57.47 (7.39)	62.92 (7.39)	68.29 (7.39)
	CASE KG (CUBE M³)	21,38 (0,21)	23,78 (0,21)	26,07 (0,21)	28,54 (0,21)	30,98 (0,21)
	LIST PRICE KIT	\$ 396.20	\$ 456.80	\$ 480.00	\$ 540.80	\$ 582.40
72" 1830 mm	CODE	EA213672	EA214272	EA214872	EA215472	EA216072
	CASE LBS. (CUBE)	47.77 (7.39)	53.05 (7.39)	58.11 (7.39)	63.56 (7.39)	68.93 (7.39)
	CASE KG (CUBE M³)	21,67 (0,21)	24,07 (0,21)	26,36 (0,21)	28,83 (0,21)	31,27 (0,21)
	LIST PRICE KIT	\$ 397.95	\$ 458.55	\$ 481.75	\$ 542.55	\$ 584.15

Includes 2 stationary posts with leveling feet installed - pre-assembled with post connectors and wedges,
1 bag of 32 stationary traverse dovetails (16 A and 16 B), vented shelf plates (for 4 shelves), 8 stationary traverses and instructions.
Case Pack: 1 Color: Brushed Graphite (580).

Vented 4-Shelf Stationary Add-On Units 24" Width (610 mm)

HEIGHT 64" 1630 mm	LENGTH	36"	42"	48"	54"	60"
		910 mm	1070 mm	1220 mm	1380 mm	1530 mm
64" 1630 mm	CODE	EA243664	EA244264	EA244864	EA245464	EA246064
	CASE LBS. (CUBE)	51.50 (8.49)	57.32 (8.49)	63.72 (8.49)	69.70 (8.49)	73.42 (8.49)
	CASE KG (CUBE M³)	23,36 (0,24)	25,99 (0,24)	28,91 (0,24)	31,62 (0,24)	34,29 (0,24)
	LIST PRICE KIT	\$ 408.45	\$ 462.65	\$ 498.25	\$ 549.05	\$ 586.65
72" 1830 mm	CODE	EA243672	EA244272	EA244872	EA245472	EA246072
	CASE LBS. (CUBE)	52.14 (8.49)	57.96 (8.49)	64.36 (8.49)	70.34 (8.49)	74.26 (8.49)
	CASE KG (CUBE M³)	23,65 (0,24)	26,29 (0,24)	29,20 (0,24)	31,91 (0,24)	34,58 (0,24)
	LIST PRICE KIT	\$ 410.30	\$ 464.50	\$ 500.10	\$ 550.90	\$ 588.50
*84" 2140 mm	CODE	EA243684PKG	EA244284PKG	EA244884PKG	EA245484PKG	EA246084PKG
	CASE LBS. (CUBE)	50.38 (11.62)	56.20 (12.88)	62.60 (10.05)	69.58 (11.91)	75.48 (11.82)
	CASE KG (CUBE M³)	22,85 (0,12)	25,49 (0,16)	28,40 (0,14)	31,56 (0,18)	34,24 (0,18)
	LIST PRICE KIT	\$ 423.20	\$ 477.40	\$ 513.00	\$ 563.80	\$ 601.40

Includes 2 stationary posts with leveling feet installed - pre-assembled with post connectors and wedges,
1 bag of 32 stationary traverse dovetails (16 A and 16 B), vented shelf plates (for 4 shelves), 8 stationary traverses, instructions
Case Pack: 1 Color: Brushed Graphite (580).

* Due to the size of 84" (2140 mm) shelving, add-on units ship in 2 cartons.

Mobile Post Kits

Camshelving®
Elements Series



	WIDTH	18" 460 mm	21" 540 mm	24" 610 mm
HEIGHT 70" 1778 mm	CODE	EMPK1870	EMPK2170	EMPK2470
	CASE LBS. (CUBE)	8.66 (0.46)	8.84 (0.46)	9.02 (0.46)
	CASE KG (CUBE M³)	3,93 (0,01)	4,01 (0,01)	4,09 (0,01)
	LIST PRICE KIT	\$ 84.40	\$ 86.45	\$ 87.15
78" 1980 mm	CODE	EMPK1878	EMPK2178	EMPK2478
	CASE LBS. (CUBE)	9.50 (0.52)	9.68 (0.52)	9.86 (0.52)
	CASE KG (CUBE M³)	4,31 (0,01)	4,39 (0,01)	4,47 (0,01)
	LIST PRICE KIT	\$ 86.25	\$ 88.20	\$ 89.00

Includes 2 mobile posts without leveling feet installed, 1 top post connector, 1 bottom post connector, 8 post connector wedges in a bag and instructions.
Casters are not included and must be ordered separately. **Note:** Height in chart includes casters.
Case Pack: 1 **Color:** Brushed Graphite (580).

Solid Shelf Kits for Mobile Units

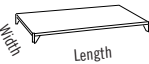

	LENGTH	36" 910 mm	42" 1070 mm	48" 1220 mm	54" 1380 mm	60" 1530 mm
WIDTH 18" 460 mm	CODE	EMSK1836S	EMSK1842S	EMSK1848S	EMSK1854S	EMSK1860S
	CASE LBS. (CUBE)	9.69 (1.51)	11.55 (2.03)	12.25 (1.54)	13.99 (2.63)	15.85 (2.91)
	CASE KG (CUBE M³)	4,40 (0,04)	5,24 (0,06)	5,55 (0,04)	6,35 (0,07)	7,12 (0,08)
	LIST PRICE KIT	\$ 78.95	\$ 93.20	\$ 97.85	\$ 112.20	\$ 122.30
21" 540 mm	CODE	EMSK2136S	EMSK2142S	EMSK2148S	EMSK2154S	EMSK2160S
	CASE LBS. (CUBE)	11.11 (1.51)	13.08 (2.03)	14.16 (1.54)	16.01 (2.63)	17.98 (2.91)
	CASE KG (CUBE M³)	5,04 (0,04)	5,93 (0,06)	6,24 (0,04)	7,26 (0,07)	8,16 (0,08)
	LIST PRICE KIT	\$ 88.95	\$ 104.40	\$ 111.85	\$ 127.30	\$ 138.00
24" 610 mm	CODE	EMSK2436S	EMSK2442S	EMSK2448S	EMSK2454S	EMSK2460S
	CASE LBS. (CUBE)	11.87 (1.51)	13.96 (2.03)	15.36 (1.54)	17.34 (2.63)	19.43 (2.91)
	CASE KG (CUBE M³)	5,38 (0,04)	6,33 (0,06)	6,97 (0,04)	7,86 (0,07)	8,81 (0,08)
	LIST PRICE KIT	\$ 93.40	\$ 107.15	\$ 116.80	\$ 130.70	\$ 141.15

Includes solid shelf plates for 1 shelf, 2 mobile traverses, 1 bag of 8 mobile traverse dovetails (4 each A and B) and instructions.
Case Pack: 1 **Color:** Brushed Graphite (580).

Vented Shelf Kits for Mobile Units

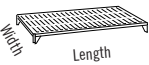

	LENGTH	36" 910 mm	42" 1070 mm	48" 1220 mm	54" 1380 mm	60" 1530 mm
WIDTH 18" 460 mm	CODE	EMSK1836V	EMSK1842V	EMSK1848V	EMSK1854V	EMSK1860V
	CASE LBS. (CUBE)	9.22 (1.51)	10.93 (2.03)	11.59 (1.54)	13.18 (2.63)	14.89 (2.91)
	CASE KG (CUBE M³)	4,18 (0,04)	4,96 (0,06)	5,26 (0,04)	5,97 (0,07)	6,75 (0,08)
	LIST PRICE KIT	\$ 75.70	\$ 89.10	\$ 93.95	\$ 107.20	\$ 116.40
21" 540 mm	CODE	EMSK2136V	EMSK2142V	EMSK2148V	EMSK2154V	EMSK2160V
	CASE LBS. (CUBE)	10.20 (1.51)	12.10 (2.03)	12.93 (1.54)	14.71 (2.63)	16.61 (2.91)
	CASE KG (CUBE M³)	4,63 (0,04)	5,49 (0,06)	5,86 (0,04)	6,67 (0,07)	7,53 (0,08)
	LIST PRICE KIT	\$ 84.65	\$ 99.85	\$ 105.65	\$ 120.80	\$ 131.20
24" 610 mm	CODE	EMSK2436V	EMSK2442V	EMSK2448V	EMSK2454V	EMSK2460V
	CASE LBS. (CUBE)	11.02 (1.51)	13.05 (2.03)	14.21 (1.54)	16.12 (2.63)	18.15 (2.91)
	CASE KG (CUBE M³)	4,99 (0,04)	5,92 (0,06)	6,45 (0,04)	7,31 (0,07)	8,23 (0,08)
	LIST PRICE KIT	\$ 87.60	\$ 101.15	\$ 110.05	\$ 122.70	\$ 132.15

Includes vented shelf plates for 1 shelf, 2 mobile traverses, 1 bag of 8 mobile traverse dovetails (4 each A and B) and instructions.
Case Pack: 1 **Color:** Brushed Graphite (580).

Vented 4-Shelf Mobile Starter Units 18" Width (460 mm)

Camshelving®
Elements Series



HEIGHT	LENGTH	36"	36"	42"	42"	48"	48"
		910 mm PREMIUM	910 mm STANDARD	1070 mm PREMIUM	1070 mm STANDARD	1220 mm PREMIUM	1220 mm STANDARD
70" 1778 mm	CODE	EMU183670P	EMU183670	EMU184270P	EMU184270	EMU184870P	EMU184870
	CASE LBS. (CUBE)	60.13 (5.92)	60.13 (5.92)	64.67 (5.92)	64.67 (5.92)	69.08 (5.92)	69.08 (5.92)
	CASE KG (CUBE M³)	33,48 (0,17)	33,48 (0,17)	36,52 (0,17)	36,52 (0,17)	39,61 (0,17)	39,61 (0,17)
	LIST PRICE KIT	\$ 671.60	\$ 655.60	\$ 725.20	\$ 709.20	\$ 744.60	\$ 728.60
78" 1980 mm	CODE	EMU183678P	EMU183678	EMU184278P	EMU184278	EMU184878P	EMU184878
	CASE LBS. (CUBE)	61.41 (5.92)	61.41 (5.92)	65.95 (5.92)	65.95 (5.92)	70.36 (5.92)	70.36 (5.92)
	CASE KG (CUBE M³)	34,06 (0,17)	34,06 (0,17)	37,09 (0,17)	37,09 (0,17)	40,19 (0,17)	40,19 (0,17)
	LIST PRICE KIT	\$ 675.30	\$ 659.30	\$ 728.90	\$ 712.90	\$ 748.30	\$ 732.30

Premium - Includes 4 mobile posts without leveling feet, post connectors and wedges installed, 1 bag of 32 mobile traverse dovetails (16 each A and B), vented shelf plates, 8 mobile traverses, 4 premium casters and instructions.
Standard - Includes 4 mobile posts without leveling feet, post connectors and wedges installed, 1 bag of 32 mobile traverse dovetails (16 each A and B), vented shelf plates, 8 mobile traverses, 4 standard casters and instructions.
Case Pack: 1 **Color:** Brushed Graphite (580).

Vented 4-Shelf Mobile Starter Units 21" Width (540 mm)



HEIGHT	LENGTH	36"	36"	42"	42"	48"	48"
		910 mm PREMIUM	910 mm STANDARD	1070 mm PREMIUM	1070 mm STANDARD	1220 mm PREMIUM	1220 mm STANDARD
70" 1778 mm	CODE	EMU213670P	EMU213670	EMU214270P	EMU214270	EMU214870P	EMU214870
	CASE LBS. (CUBE)	65.08 (7.39)	65.08 (7.39)	70.37 (7.39)	70.37 (7.39)	75.43 (7.39)	75.43 (7.39)
	CASE KG (CUBE M³)	35,72 (0,21)	35,72 (0,21)	39,10 (0,21)	39,10 (0,21)	42,49 (0,21)	44,82 (0,21)
	LIST PRICE KIT	\$ 711.50	\$ 695.50	\$ 772.30	\$ 756.30	\$ 795.50	\$ 779.50
78" 1980 mm	CODE	EMU213678P	EMU213678	EMU214278P	EMU214278	EMU214878P	EMU214878
	CASE LBS. (CUBE)	66.36 (7.39)	66.36 (7.39)	71.65 (7.39)	71.65 (7.39)	76.71 (7.39)	76.71 (7.39)
	CASE KG (CUBE M³)	36,31 (0,21)	36,31 (0,21)	39,68 (0,21)	39,68 (0,21)	43,07 (0,21)	45,40 (0,21)
	LIST PRICE KIT	\$ 715.00	\$ 699.00	\$ 775.80	\$ 759.80	\$ 799.00	\$ 783.00

Premium - Includes 4 mobile posts without leveling feet, post connectors and wedges installed, 1 bag of 32 mobile traverse dovetails (16 each A and B), vented shelf plates, 8 mobile traverses, 4 premium casters and instructions.
Standard - Includes 4 mobile posts without leveling feet, post connectors and wedges installed, 1 bag of 32 mobile traverse dovetails (16 each A and B), vented shelf plates, 8 mobile traverses, 4 standard casters and instructions.
Case Pack: 1 **Color:** Brushed Graphite (580).

Vented 4-Shelf Mobile Starter Units 24" Width (610 mm)



HEIGHT	LENGTH	36"	36"	42"	42"	48"	48"
		910 mm PREMIUM	910 mm STANDARD	1070 mm PREMIUM	1070 mm STANDARD	1220 mm PREMIUM	1220 mm STANDARD
70" 1778 mm	CODE	EMU243670P	EMU243670	EMU244270P	EMU244270	EMU244870P	EMU244870
	CASE LBS. (CUBE)	69.64 (8.49)	69.64 (8.49)	75.45 (8.49)	75.45 (8.49)	81.86 (8.49)	81.86 (8.49)
	CASE KG (CUBE M³)	37,79 (0,24)	37,79 (0,24)	41,41 (0,24)	41,41 (0,24)	45,40 (0,24)	45,40 (0,24)
	LIST PRICE KIT	\$ 724.70	\$ 708.70	\$ 778.90	\$ 762.90	\$ 814.50	\$ 798.50
78" 1980 mm	CODE	EMU243678P	EMU243678	EMU244278P	EMU244278	EMU244878P	EMU244878
	CASE LBS. (CUBE)	70.92 (8.49)	70.92 (8.49)	76.71 (8.49)	76.71 (8.49)	83.14 (8.49)	83.14 (8.49)
	CASE KG (CUBE M³)	38,37 (0,24)	38,37 (0,24)	41,99 (0,24)	41,99 (0,24)	45,98 (0,24)	45,98 (0,24)
	LIST PRICE KIT	\$ 728.40	\$ 712.40	\$ 782.60	\$ 766.60	\$ 818.20	\$ 802.20

Premium - Includes 4 mobile posts without leveling feet, connectors and wedges installed, 1 bag of 32 mobile traverse dovetails (16 each A and B), vented shelf plates, 8 mobile traverses, 4 premium casters, instructions.
Standard - Includes 4 posts without leveling feet, connectors and wedges installed, 1 bags of 32 mobile traverse dovetails (16 each A and B), shelf plates, 8 mobile traverses, 4 standard casters, instructions
Case Pack: 1 **Color:** Brushed Graphite (580).

Casters and Donut Bumper

Camshelving®
Elements Series



DIAMETER	5" 127 mm PREMIUM	5" 127 mm PREMIUM	5" 127 mm STANDARD	5" 127 mm STANDARD	5" 127 mm
CODE	EMSCBP	EMSCP	EMSCB	EMSC	CSHDDB
DESCRIPTION	Swivel with Brake	Swivel No Brake	Swivel with Brake	Swivel No Brake	Donut Bumper
CASE LBS. (CUBE)	4.75 (0.16)	4.35 (0.16)	4.75 (0.16)	4.35 (0.16)	2.01 (0.05)
CASE KG (CUBE M³)	2,16 (0,005)	1,97 (0,005)	2,16 (0,005)	1,97 (0,005)	0,91 (0,001)
CASE PACK	2	2	2	2	4
LIST PRICE EACH	\$ 55.00	\$ 45.00	\$ 47.00	\$ 45.00	\$ 10.70

PREMIUM CASTERS - Stainless steel with a non-marking polyurethane wheel. Recommended for use in wet areas or in walk-in refrigerators and freezers.
STANDARD CASTERS - Zinc plated with a non-marking polyurethane wheel. Recommended for use in dry storage areas.

Divider Bar for Elements Series

- Creates a custom storage unit that can accommodate a variety of storage products and sizes on a single unit.
- Divider bars fit on 24" (610 mm) wide Elements Series units and hold up to 200 lbs. (91 kg) per shelf.



CODE	DESCRIPTION	CASE LBS. (CUBE)	CASE KG (CUBE M³)	LIST PRICE EA.
EDBA	Divider Bar Angled	1.91 (0.10)	0,87 (0,003)	\$ 4.40
EDBS	Divider Bar Straight	1.91 (0.10)	0,87 (0,003)	4.40

Case Pack: 4 Color: Speckled Gray (480).

Camshelving Elements Cash & Carry 4-Shelf Stationary Starter Unit

- Easy to merchandise in Cash and Carry showrooms. Innovative, lighter-weight packaging features less corrugate and an appealing POS merchandising label.



Contact your Cambro Sales Representative for more information on sizes and pricing.

Dunnage Racks



S-Series Dunnage Racks

- Keep frozen, cold or dry inventory 12" (30,5 cm) safely off the floor.
- One piece construction and sturdy legs provide strength and stability.
- Heavy duty polypropylene is safe to -36°F (-38°C), and will not rust, corrode or bend.
- Choose slotted tops for maximum air circulation around perishable products.
- Solid tops catch spills for easy clean up.

Colors: Dark Brown (131),
Speckled Gray (480).



CODE	EXTERIOR DIMENSIONS H x D x W	LOAD CAPACITY	CASE LBS. (CUBE)	LIST PRICE EA
Solid Top				
DRS30	12" x 21" x 30"	1500 lbs.	22.05 (4.75)	\$ 220.00
DRS36	12" x 21" x 36"	1500 lbs.	26 (5.72)	240.00
DRS48	12" x 21" x 48"	3000 lbs.	35.10 (7.41)	290.00
DRS60	12" x 21" x 60"	3000 lbs.	44.66 (9.53)	330.00
Slotted Top				
DRS300	12" x 21" x 30"	1500 lbs.	20 (4.78)	220.00
DRS360	12" x 21" x 36"	1500 lbs.	25 (5.72)	240.00
DRS480	12" x 21" x 48"	3000 lbs.	34.07 (7.45)	290.00
DRS600	12" x 21" x 60"	3000 lbs.	42.37 (9.36)	330.00

Case Pack: 1 InStock Color: Speckled Gray (480).

Camlink®

Camlink connectors securely lock dunnage racks together for greater stability.



Color: Black (110).

CODE	CASE PACK	LIST PRICE EA.
DRLNK	6	\$ 2.40

Camlink is covered by U.S. Patent D 397,289.

Camlink fits all sizes and styles. One free Camlink supplied with every Dunnage Rack.





STORAGE

Pizza Dough Boxes



Polypropylene

- Ideal for storing, transporting, proofing and cooling dough.
- Lightweight, durable, and break resistant.
- Chemical resistant material won't absorb odors and is easy to clean.
- Boxes nest tightly together to keep out dirt and contaminants, extending product freshness.

- The previous box acts as a tight lid for the box below, reducing the need and expense of covers.
- Withstands temperatures from -40°F to 160°F.*
- Cover can be used as an 18" x 26" tray.

Color: White (148).

Polycarbonate & Polypropylene dough boxes do not inter stack.

* Polypropylene dough boxes are safe for use in high temperature dishwashers.

Caster Type A: 5" Casters: 2 fixed, 2 swivel, 1 with brake.



CD1826PDB

Capacity: 300 Lbs.

Caster Type: A

Holds: DB18263CW, DB18266CW, DB18263P



Camwear® Polycarbonate

- Prevents crusting to increase the storage life of dough.
- Virtually unbreakable polycarbonate construction is reinforced on all sides.
- Boxes won't bend or lose their shape.

- Withstands temperatures from -40°F to 210°F.
- Available in 3" and 6" depths.



DB18263CW

1.800.833.3003

CODE	OUTSIDE DIMENSIONS INSIDE DIMENSIONS	CASE LBS. (CUBE)	LIST PRICE EA.
Polypropylene Pizza Dough Box			
DB18263P	18" x 26" x 3" 16" x 24"	24.35 (5.37)	\$ 39.40
Polypropylene Cover			
DBC1826P	18" x 26"	17.85 (2.27)	26.50
Case Pack: 6 InStock Color: White (148).			
Camwear Pizza Dough Boxes			
DB18263CW	18" x 26" x 3" 16" x 24"	24.03 (4.62)	49.25
DB18266CW	18" x 26" x 6" 16" x 24"	35.5 (9.47)	66.20
Camwear Cover			
DBC1826CW	18" x 26"	14.81 (1.21)	35.90
Case Pack: 6			
Camdolly® For Pizza Dough Boxes			
CD1826PDB**	19 ⁷ / ₈ " x 27 ⁷ / ₈ " x 10 ¹ / ₄ " 17 ¹ / ₁₆ " x 25 ³ / ₈ "	22 (3.67)	340.00
Case Pack: 1 **Optional Strap Available			

Quick Guide To Storage Solutions



Storage Containers

CamSquares® Food Storage Containers

Keeps food fresh and maximizes storage areas.



7	3	2
SIZES	MATERIALS	LID TYPES

Coldfest®

GN Pans

Holds cold food at safe temperatures without ice for hours.



4	1	1	5
SIZES	DEPTH	MATERIAL	LID TYPES

Round Food Storage Containers

Store ingredients or transport ready to serve or partially prepared foods.



8	3	4
SIZES	MATERIALS	LID TYPES

Ingredient Bins

Store dry bulk ingredients such as flour and grain.



6	1	3
CAPACITIES	COLOR	LID TYPES

Food Storage Boxes

Safely store bulk produce, meat, poultry and seafood.



2	5	2	2
SIZES	DEPTHS	MATERIALS	LID TYPES



Materials

Camwear® Polycarbonate

Virtually unbreakable polycarbonate material will not crack, bend or dent. Withstands temperatures from -40°F to 210°F (-40°C to 99°C).



High Heat H-Pans™

High heat material is safe for use in microwaves, ovens and steam tables. Withstands extreme temperatures from -40°F to 375°F (-40°C to 190°C).



Polypropylene

Translucent polypropylene material provides a high chemical resistance. Withstands temperatures from -40°F to 160°F (-40°C to 70°C).



Polyethylene

High chemical and impact resistant material. Withstands temperatures from -40°F to 160°F (-40°C to 70°C).



ABS

High-performance and impact resistant material. Ideal for temperatures at or below 41°F (4°C).



Food Pans

Camwear® Polycarbonate Food Pans

Store, transport and serve all in one pan. Virtually unbreakable polycarbonate will not crack, bend or dent. Withstands temperatures from -40°F to 210°F (-40°C to 99°C).



7 SIZES	4 DEPTHS	3 COLORS	7 LID TYPES
------------	-------------	-------------	----------------

Translucent Food Pans

An economical choice for storage and serving. Ideal for use in cold and ambient environments. Withstands temperatures from -40°F to 160°F (-40°C to 70°C).



6 SIZES	2 DEPTHS	1 COLOR	4 LID TYPES
------------	-------------	------------	----------------

High Heat H-Pans™

Pans can go from prep to cooler to oven to steam table. Withstands temperatures from -40°F to 375°F (-40°C to 190°C).



7 SIZES	3 DEPTHS	2 COLORS	7 LID TYPES
------------	-------------	-------------	----------------

Colander Pans

Liquids drain away from food into the pan below for enhanced food quality and improved food safety.



4 SIZES	2 DEPTHS	2 MATERIALS	3 LID TYPES
------------	-------------	----------------	----------------

Food Pan Lids

Covers protect contents better than plastic wrap or foil while saving time and money. Lids improve food safety and extend product freshness. Fit selected Camwear, High Heat and Poly Food Pans.

Flat Cover

Basic cover available in all pan sizes.



Cover with Handle

Deep molded handle provides secure grip. Available in Black and Clear.



Notched Cover with Handle

Notched cover allows utensils to remain in pan and off of potentially contaminated counters.



FlipLid®

Keeps contents covered yet flips up easily for service.



Notched FlipLid

FlipLid with notch to rest spoon in contents with lid closed.



Seal Cover

Economical cover for all pan sizes. Fits Camwear and High Heat pans.



GripLid®

Lid grips the side of the pan, reducing spills and points of cross contamination. Fits Camwear and High Heat pans.



Seal Cover for Translucent Food Pans

Translucent seal covers provide a tight fit, to protect food quality while eliminating the expense of plastic wrap.



Camwear® Polycarbonate CamSquare® Food Storage Containers

Maximize your storage area with CamSquare food storage containers. The square shape provides 33% better space usage than traditional round containers. Clear polycarbonate provides product visibility for at a glance inventory management. Seal covers feature an inner and outer seal for superior spill resistance, even during transport.

Note: All graduations are approximate.



Tight fitting Seal Cover is spill resistant, saves expense & is safer for employees to handle during transport.



Interstacking saves space when not in use.



Wide molded-in handles on larger sizes ease carrying. Molded-in holes offer quick and sanitary drying.

Stain and odor resistant.

Crystal clear, virtually unbreakable Camwear polycarbonate withstands temperatures from -40°F to 210°F (-40°C to 99°C).

Easy to read graduations printed on the outside for quick inventory management.

Seal Covers for Camwear CamSquares*

- Inner and outer seal provide excellent spill resistance.
- Includes a hole on the corner for hanging during storage.
- Translucent lid easily identifies contents.
- Withstands temperatures from -40°F to 160°F (-40°C to 70°C).

* Seal covers only fit Camwear Square Containers.



CamSquare® Food Storage Containers

Translucent

- Translucent material provides some content visibility and high chemical resistance.
- Withstands temperatures from -40°F to 160°F (-40°C to 70°C).
- Easy to read graduations are printed on the outside for at a glance inventory management.

Note: All graduations are approximate.



Poly

- Economical storage choice.
- Made of impact, stain and chemical resistant material.
- Withstands temperatures from -40°F to 160°F (-40°C to 70°C).

Note: All graduations are approximate.



Covers for CamSquares

- Snap-tight polyethylene covers feature thumb tabs for easy removal.
- Covers fit Camwear®, Translucent and Poly CamSquare Containers.



Personalized Storage Products

Personalize food storage products to identify menu items, add fill lines for recipes, or use personalization in multiple languages to help ensure product quality and consistency.



Camwear® Polycarbonate CamSquare® Food Storage Containers



Camwear

CODE	2SFSCW	4SFSCW	6SFSCW	8SFSCW	12SFSCW**	18SFSCW**	22SFSCW**
CAPACITY	2 qt.	4 qt.	6 qt.	8 qt.	12 qt.	18 qt.	22 qt.
DIM. L x W x H	7¼" x 7¼" x 3¼"	7¼" x 7¼" x 7¾"	8¾" x 8¾" x 7¼"	8¾" x 8¾" x 9¾"	11¼" x 12¼" x 8¾"	11¼" x 12¼" x 12¾"	11¼" x 12¼" x 15¾"
CASE LBS. (CUBE)	3.34 (0.42)	5.28 (0.61)	7.01 (0.97)	8.41 (1.09)	12.98 (2.31)	19.65 (2.74)	24.3 (3.05)
LIST PRICE EACH	\$ 8.55	\$ 13.05	\$ 16.90	\$ 19.85	\$ 26.45	\$ 39.25	\$ 49.75

Case Pack: 6 Color/InStock Color: Clear (135). Height includes covers.

Seal Covers For Camwear CamSquares*



CODE	SFC2SCPP	SFC6SCPP	SFC12SCPP
DESCRIPTION	Fits 2 & 4 qt.	Fits 6 & 8 qt.	Fits 12, 18 & 22 qt.
CASE LBS. (CUBE)	1.25 (0.11)	1.57 (0.16)	2.54 (0.25)
LIST PRICE EACH	\$ 3.45	\$ 4.30	\$ 6.25

Case Pack: 6 InStock Color: Translucent (190).

Note: All graduations are approximate.

* Seal covers fit Camwear Polycarbonate CamSquare containers only.

** Dimensions include handles.



PRORATED

CamSquare® Food Storage Containers



Translucent



CODE	2SFSP	4SFSP	6SFSP	8SFSP	12SFSP**	18SFSP**	22SFSP**
CAPACITY	2 qt.	4 qt.	6 qt.	8 qt.	12 qt.	18 qt.	22 qt.
DIM. L x W x H	7¼" x 7¼" x 3⅝"	7¼" x 7¼" x 7⅝"	8⅝" x 8⅝" x 7¼"	8⅝" x 8⅝" x 9⅝"	11¼" x 12¼" x 8¼"	11¼" x 12¼" x 12⅝"	11¼" x 12¼" x 15¼"
CASE LBS. (CUBE)	2.6 (0.42)	4.45 (0.61)	5.62 (0.98)	6.87 (1.05)	9 (2.34)	14.75 (2.74)	19.10 (3.01)
LIST PRICE EACH	\$ 6.70	\$ 9.20	\$ 11.40	\$ 13.50	\$ 19.05	\$ 25.90	\$ 31.90

Case Pack: 6 Color/InStock Color: Translucent (190). Height includes covers.

Poly



CODE	2SFSP	4SFSP	6SFSP	8SFSP	12SFSP**	18SFSP**	22SFSP**
CAPACITY	2 qt.	4 qt.	6 qt.	8 qt.	12 qt.	18 qt.	22 qt.
DIM. L x W x H	7¼" x 7¼" x 3⅝"	7¼" x 7¼" x 7⅝"	8⅝" x 8⅝" x 7¼"	8⅝" x 8⅝" x 9⅝"	11¼" x 12¼" x 8¼"	11¼" x 12¼" x 12⅝"	11¼" x 12¼" x 15¼"
CASE LBS. (CUBE)	2.43 (0.41)	4.49 (0.61)	5.66 (0.93)	7.4 (1.06)	9 (2.34)	14.75 (2.74)	20.25 (3.05)
LIST PRICE EACH	\$ 6.35	\$ 8.65	\$ 10.75	\$ 12.75	\$ 18.15	\$ 24.55	\$ 30.00

Case Pack: 6 Color: Natural White (148). Height includes covers.

Covers*



CODE	SFC2	SFC6	SFC12
COLOR	Kelly Green (452)	Winter Rose (451)	Midnight Blue (453)
DESCRIPTION	Fits 2 & 4 qt.	Fits 6 & 8 qt.	Fits 12, 18 & 22 qt.
CASE LBS. (CUBE)	1.25 (0.11)	1.64 (0.16)	2.54 (0.25)
LIST PRICE EACH	\$ 3.45	\$ 4.30	\$ 6.25

Case Pack: 6 InStock Color: Kelly Green (452), Winter Rose (451), Midnight Blue (453).

Note: All graduations are approximate.

* PolyCovers fit Camwear, Translucent and Poly CamSquare Containers.

** Dimensions include handles.



Camwear® Polycarbonate Round Food Storage Containers

Store ingredients or transport ready to serve or partially prepared foods. Clear Camwear polycarbonate allows for easy content identification at a glance. Reduces risk of contamination and enhances food safety. Round shape promotes proper air circulation, ideal for stirring soups and sauces.

Note: All graduations are approximate.

Note: To order Round Food Storage Containers without imprinted graduations, simply add "N" to the end of the code number.

Lids are not interchangeable.



Seal Cover provides excellent spill resistance.

Crystal clear, virtually unbreakable Camwear polycarbonate withstands temperatures from -40°F to 210°F (-40°C to 99°C).

Molded-in handles ease carrying. Molded-in holes offer quick and sanitary drying.



Resists food acids, oils & alcohol. Stain and odor resistant.

Interstacking saves space when not in use.

Easy to read graduations on the outside for at a glance inventory management.

Camwear Polycarbonate Covers

- Snap on covers fit tightly.
- Stain resistant to food acids and oils.
- Withstands temperatures from -40°F to 210°F (-40°C to 99°C).



Round Seal Covers

- Inner and outer seal provide excellent spill resistance.
- Safe from -40°F to 160°F (-40°C to 70°C).
- Thumb tab for easy removal.

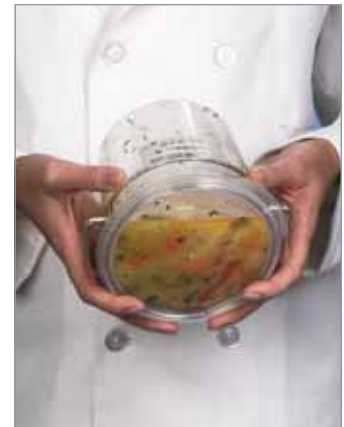

Round Food Storage Containers

Translucent

- Translucent material offers some product visibility.
- Rounds are durable and resistant to stains.
- Withstands temperatures from -40°F to 160°F (-40°C to 70°C).
- Snap on covers fit tightly to protect contents and extend product freshness.

Note: All graduations are approximate.

Note: To order Round Food Storage Containers without imprinted graduations, simply add "N" to the end of the code number.

Lids are not interchangeable.



Poly

- Impact, stain and chemical resistant material.
- An affordable storage choice.
- Safe from -40°F to 160°F (-40°C to 70°C).
- Snap on covers fit tightly yet are easily removed.

Note: All graduations are approximate.

Note: To order Round Food Storage Containers without imprinted graduations, simply add "N" to the end of the code number.

Lids are not interchangeable.



Camwear® Polycarbonate Round Food Storage Containers



Camwear Polycarbonate



CODE	RFSCW1	RFSCW2	RFSCW4	RFSCW6	RFSCW8	RFSCW12	RFSCW18	RFSCW22
CAPACITY	1 qt.	2 qt.	4 qt.	6 qt.	8 qt.	12 qt.	18 qt.	22 qt.
DIMENSIONS	Top Dia. 6 ¹ / ₁₆ " Height 5"	Top Dia. 8 ³ / ₁₆ " Height 4 ³ / ₁₆ "	Top Dia. 8 ⁷ / ₁₆ " Height 8 ⁷ / ₁₆ "	Top Dia. 9 ¹⁵ / ₁₆ " Height 7 ¹⁵ / ₁₆ "	Top Dia. 9 ¹⁵ / ₁₆ " Height 10 ⁷ / ₈ "	Top Dia. 14 ⁷ / ₈ " Height 8 ³ / ₈ "	Top Dia. 14 ⁷ / ₈ " Height 12"	Top Dia. 14 ⁷ / ₈ " Height 15"
CASE PACK	12	12	12	12	12	6	6	6
CASE LBS. (CUBE)	4.50 (0.44)	6.57 (0.70)	10.75 (0.83)	3.47 (0.31)	15.75 (1.46)	11.52 (1.79)	16.25 (2.63)	19.17 (3.27)
LIST PRICE EACH	\$ 6.65	\$ 9.20	\$ 15.55	\$ 18.20	\$ 23.05	\$ 32.55	\$ 44.65	\$ 51.40

Color/InStock Color: Clear (135). Top diameter dimension includes handle. Height dimension includes cover.
Two year warranty on Polycarbonate Rounds.



Camwear Covers

DESCRIPTION	CASE PACK	CODE	CASE LBS. (CUBE)	LIST PRICE EA.
Fits 1 qt.	12	RFSCWC1	1.25 (0.08)	\$ 2.40
Fits 2 & 4 qt.	12	RFSCWC2	2.75 (0.24)	4.30
Fits 6 & 8 qt.	12	RFSCWC6	3.47 (0.31)	5.45
Fits 12, 18 & 22 qt.	6	RFSCWC12	4.2 (0.42)	12.45

Color/InStock Color: Clear (135).

Seal Covers for Camwear Rounds

DESCRIPTION	CASE PACK	CODE	CASE LBS. (CUBE)	LIST PRICE EA.
Fits 1 qt.	12	RFS1SCPP	1.04 (0.05)	\$ 2.05
Fits 2 & 4 qt.	12	RFS2SCPP	2.03 (0.37)	3.15
Fits 6 & 8 qt.	12	RFS6SCPP	2.7 (0.27)	3.25
Fits 12, 18 & 22 qt.	6	RFS12SCPP	3.23 (0.51)	7.00

Color/InStock Color: Translucent (190).

Round Food Storage Containers



Translucent



CODE	RFS1PP	RFS2PP	RFS4PP	RFS6PP	RFS8PP	RFS12PP	RFS18PP	RFS22PP
CAPACITY	1 qt.	2 qt.	4 qt.	6 qt.	8 qt.	12 qt.	18 qt.	22 qt.
DIMENSIONS	Top Dia. 6 ¹ / ₁₆ " Height 5"	Top Dia. 8 ³ / ₁₆ " Height 4 ³ / ₁₆ "	Top Dia. 8 ³ / ₁₆ " Height 8 ³ / ₁₆ "	Top Dia. 9 ¹⁵ / ₁₆ " Height 7 ¹⁵ / ₁₆ "	Top Dia. 9 ¹⁵ / ₁₆ " Height 10 ⁷ / ₈ "	Top Dia. 14 ⁷ / ₈ " Height 8 ³ / ₈ "	Top Dia. 14 ⁷ / ₈ " Height 12"	Top Dia. 14 ⁷ / ₈ " Height 15"
CASE PACK	12	12	12	12	12	6	6	6
CASE LBS. (CUBE)	2.9 (0.45)	3.68 (0.68)	6 (0.83)	8.50 (1.44)	11.35 (1.40)	7.26 (1.74)	10 (2.63)	3.70 (1.56)
LIST PRICE EACH	\$ 4.30	\$ 4.75	\$ 5.55	\$ 6.70	\$ 8.90	\$ 15.85	\$ 19.25	\$ 22.60

Color/InStock Color: Translucent (190). Top diameter dimension includes handle. Height dimension includes cover.

Poly



CODE	RFS1	RFS2	RFS4	RFS6	RFS8	RFS12	RFS18	RFS22
CAPACITY	1 qt.	2 qt.	4 qt.	6 qt.	8 qt.	12 qt.	18 qt.	22 qt.
DIMENSIONS	Top Dia. 6 ¹ / ₁₆ " Height 5"	Top Dia. 8 ³ / ₁₆ " Height 4 ³ / ₁₆ "	Top Dia. 8 ³ / ₁₆ " Height 8 ³ / ₁₆ "	Top Dia. 9 ¹⁵ / ₁₆ " Height 7 ¹⁵ / ₁₆ "	Top Dia. 9 ¹⁵ / ₁₆ " Height 10 ⁷ / ₈ "	Top Dia. 14 ⁷ / ₈ " Height 8 ³ / ₈ "	Top Dia. 14 ⁷ / ₈ " Height 12"	Top Dia. 14 ⁷ / ₈ " Height 15"
CASE PACK	12	12	12	12	12	6	6	6
CASE LBS. (CUBE)	3.06 (0.44)	3.96 (0.66)	6.25 (0.95)	8.76 (1.36)	11.57 (1.41)	7.50 (1.83)	10.24 (2.49)	13.61 (3.28)
LIST PRICE EACH	\$ 4.15	\$ 4.45	\$ 5.10	\$ 6.35	\$ 8.30	\$ 14.90	\$ 18.10	\$ 21.30

Color: Natural White (148). Top diameter dimension includes handle. Height dimension includes cover.

Covers for Translucent Rounds

DESCRIPTION	CASE PACK	CODE	CASE LBS. (CUBE)	LIST PRICE EA.
Fits 1 qt.	12	RFSC1PP	0.6 (0.08)	\$ 1.60
Fits 2 & 4 qt.	12	RFSC2PP	1.40 (0.13)	1.65
Fits 6 & 8 qt.	12	RFSC6PP	2.10 (0.20)	2.35
Fits 12, 18 & 22 qt.	6	RFSC12PP	3.6 (0.42)	5.45

Color/InStock Color: Translucent (190).

Covers for Poly Rounds

DESCRIPTION	CASE PACK	CODE	CASE LBS. (CUBE)	LIST PRICE EA.
Fits 1 qt.	12	RFSC1	0.78 (0.08)	\$ 1.40
Fits 2 & 4 qt.	12	RFSC2	1.44 (0.13)	1.45
Fits 6 & 8 qt.	12	RFSC6	2.2 (0.21)	2.05
Fits 12, 18 & 22 qt.	6	RFSC12	3.75 (0.42)	4.95

Color: Natural White (148).

Camwear® Food Storage Boxes – Eliminate the hazard of cross contamination.

Extend the freshness of ingredients and eliminate points of cross contamination by transferring product into food boxes at the receiving dock. A safe solution for storing bulk fruits and vegetables. Clear polycarbonate allows visibility for product identification. Snap tight Camwear covers or SlidingLids™, sold separately, won't come off during transportation.

SlidingLids are covered by the following U.S. Patents D 447,906 S & 6,540,098 B1.

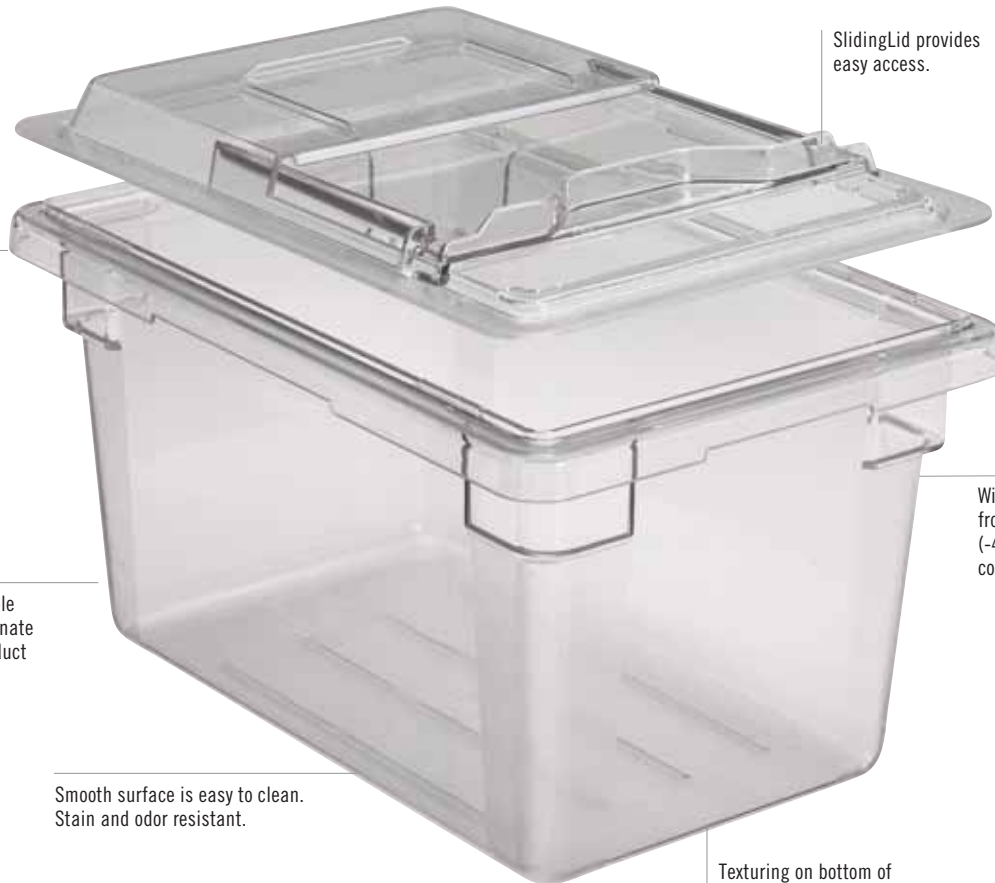

SlidingLid provides easy access.

Molded-in handles ease carrying.

Withstands temperatures from -40°F to 210°F (-40°C to 99°C) for use in coolers and freezers.

Crystal clear, durable Camwear polycarbonate allows for easy product identification.

Smooth surface is easy to clean. Stain and odor resistant.

Texturing on bottom of boxes reduces scratching.

Camwear Flat Lids

- Snap-tight covers won't come off during transport.
- Top molded-in rails for safer, more secure stacking.
- Durable Camwear polycarbonate is safe from -40°F to 210°F (-40°C to 99°C).



Camwear SlidingLids fits Camwear Food Storage Boxes

- Lid slides back to easily access contents, minimizing handling.
- Reduces the risk of cross contamination since lid remains on food box.
- Made of virtually unbreakable Camwear polycarbonate.



Food Storage Boxes

ColanderKits™

- A complete food safety system packaged in one carton.
- Store raw meats, fish on ice or bulk produce safely.
- Juices and liquids drip into the food box below for quick and easy disposal.
- Reduces handling and risk of cross contamination.



Camwear® Colanders

- Enhances food quality and reduces risk of cross contamination.
- Liquids and juices drain directly into food box for improved food safety.
- Ideal for draining fruits and vegetables, thawing meat or poultry, or storing seafood on ice.



Camwear Drain Shelves

- Camwear drain shelves fit in both Camwear boxes and white poly boxes.
- Lifts contents out of liquids to enhance food quality and freshness.
- Made of virtually unbreakable polycarbonate.



Poly Food Storage Boxes

- Economical choice for storing bulk produce and ingredients.
- Impact, stain and chemical resistant material.
- Withstands temperatures from -40°F to 160°F (-40°C to 70°C).

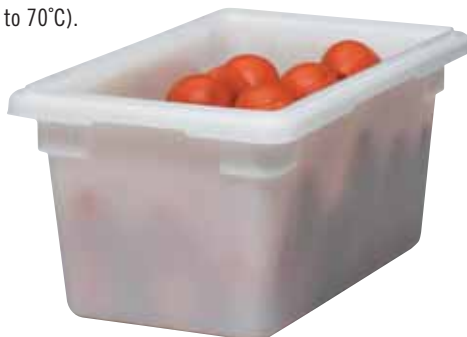

Camwear Safety Red and Yellow Food Storage Boxes

- Helps prevent cross-contamination between raw meats, poultry and other food products.
- Red and Translucent yellow color clearly identifies product inside.
- Matching flat cover also available.



Camwear® Food Boxes



Camwear Polycarbonate



CODE	18263CW	❖● 18266CW	18269CW
DIMENSIONS	18" x 26" x 3½"	18" x 26" x 6"	18" x 26" x 9"
APPROX. CAPACITY	5.0 gal.	8.75 gal.	13.0 gal.
CASE PACK	6	6	4
CASE LBS. (CUBE)	21.93 (2.14)	30.05 (4.61)	27.03 (4.45)
LIST PRICE EACH	\$ 44.00	\$ 57.00	\$ 75.00



CODE	182612CW	182615CW	12183CW	❖● 12186CW	❖ 12189CW
DIMENSIONS	18" x 26" x 12"	18" x 26" x 15"	12" x 18" x 3½"	12" x 18" x 6"	12" x 18" x 9"
APPROX. CAPACITY	17.0 gal.	22.0 gal.	1.75 gal.	3.0 gal.	4.75 gal.
CASE PACK	4	3	6	6	6
CASE LBS. (CUBE)	34.4 (5.56)	31.68 (6.56)	12.15 (1.01)	16.02 (2.13)	20.45 (2.70)
LIST PRICE EACH	\$ 91.35	\$ 107.80	\$ 24.10	\$ 30.50	\$ 41.00

Color/InStock Color: Clear (135). 18266CW & 12186CW are available in Clear & Red.

● Safety Red (467). ❖ Safety Yellow (464) Contact your Cambro representative for pricing.

Camwear Covers



CODE	❖● 1826CCW FLAT LID	1826SCCW SLIDINGLID™	❖● 1218CCW FLAT LID	1218SCCW SLIDINGLID™
DIMENSIONS	18" x 26"	18" x 26"	12" x 18"	12" x 18"
CASE LBS. (CUBE)	16.01 (0.92)	19.03 (1.72)	7.88 (0.49)	9.50 (0.72)
LIST PRICE EACH	\$ 29.85	\$ 53.45	\$ 14.90	\$ 31.80

Case Pack: 6 Color/InStock Color: Clear (135). 1826CCW & 1218CCW are available in Clear & Red.

● Safety Red (467). ❖ Safety Yellow (464) Contact your Cambro representative for pricing.

Food Storage Boxes



Poly Boxes



CODE	18263P	18266P	18269P
DIMENSIONS	18" x 26" x 3½"	18" x 26" x 6"	18" x 26" x 9"
APPROX. CAPACITY	5.0 gal.	8.75 gal.	13.0 gal.
CASE PACK	6	6	6
CASE LBS. (CUBE)	16.22 (2.16)	28.76 (4.28)	31.81 (5.58)
LIST PRICE EACH	\$ 30.80	\$ 40.45	\$ 52.75



CODE	182612P	182615P	12183P	12186P	12189P
DIMENSIONS	18" x 26" x 12"	18" x 26" x 15"	12" x 18" x 3½"	12" x 18" x 6"	12" x 18" x 9"
APPROX. CAPACITY	17.0 gal.	22.0 gal.	1.75 gal.	3.0 gal.	4.75 gal.
CASE PACK	4	3	6	6	6
CASE LBS. (CUBE)	34.4 (5.56)	27.25 (6.56)	9.42 (0.91)	11.97 (1.98)	16.45 (2.54)
LIST PRICE EACH	\$ 63.95	\$ 75.25	\$ 18.60	\$ 23.20	\$ 30.65

Color/InStock Color: Natural White (148).

Poly Covers



CODE	1826CP FLAT LID	1218CP FLAT LID
DIMENSIONS	18" x 26"	12" x 18"
CASE LBS. (CUBE)	13.18 (0.93)	5.69 (0.43)
LIST PRICE EACH	\$ 23.75	\$ 14.30

Camwear and Poly Lids are not interchangeable.

Case Pack: 6 Color/InStock Color: Natural White (148).

Accessories



CODE	1826DSCW	1218DSCW	1826CLRCW (5" DEEP)	18268CLRCW (8" DEEP)	18268CLRKIT
DESCRIPTION	Drain Shelf	Drain Shelf	Colander	Colander	ColanderKit™
DIMENSIONS	Fits 18" x 26" Food Storage Boxes	Fits 12" x 18" Food Storage Boxes	Fits Camwear Food Storage Boxes 18" x 26" x 6" and deeper	Fits Camwear Food Storage Boxes 18" x 26" x 9" and deeper	One 8" Deep Colander One 18" x 26" x 9" Food Box One 18" x 26" SlidingLid™
CASE PACK	6	6	6	4	1 Kit
CASE LBS. (CUBE)	10.91 (0.91)	3.75 (0.22)	28 (2.59)	24.25 (3.30)	16.71 (3.05)
LIST PRICE EACH	\$ 24.55	\$ 9.70	\$ 47.15	\$ 81.55	\$ 209.95

Color/InStock Color: Clear (135).

StoreSafe® Food Rotation Labels

- Label and adhesive dissolve in less than 30 seconds.
- Leaves behind no sticky residue which can be a breeding ground for bacteria.
- Assists in a proper First In First Out (FIFO) food storage system.
- Run under hot or cold water or through the dishwasher.
- Safe for all sewer and septic systems. Will not build up in drains.
- Withstands high heat temperatures up to 200°F (93°C) for 4 hours. Microwave safe.
- Withstands freezer temperatures up to -40°F (-40°C).

Label color: White.

* Available for ordering in cases only.
No broken cartons.

100% biodegradable.
FDA approved material.



Eliminates sticky residue and prevents cross contamination! No more scraping!



Dissolves completely within 30 seconds off all containers when placed through dishwasher or under running water.



100%
DISSOLVABLE and
BIODEGRADABLE



Retail Blister Pack

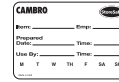

CASE CODE	23SL
LABEL SIZE	2" x 3"
CASE PACK	20 rolls, 100 labels per roll
CASE LBS. (CUBE)	5 (1.2)
LIST PRICE EACH	\$ 381.10

Half Size Bulk Dispenser Pack



CASE CODE	1252SLB250	1252SLINB250
LABEL SIZE	1¼" x 2"	1¼" x 2"
CASE PACK	24 rolls, 250 labels per roll	24 rolls, 250 labels per roll
CASE LBS. (CUBE)	3.21 (0.26)	4.93 (0.26)
LIST PRICE EACH	\$ 350.20	\$ 350.20

Bulk Dispenser Pack

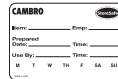
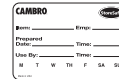

CASE CODE	23SLB250	23SLB6250
LABEL SIZE	2" x 3"	2" x 3"
CASE PACK	24 rolls, 250 labels per roll	6 rolls, 250 labels per roll
CASE LBS. (CUBE)	10.61 (0.3)	2.75 (0.12)
LIST PRICE EACH	\$ 705.55	\$ 183.35

Blank Bulk Dispenser Pack



CASE CODE	23SLINB250
LABEL SIZE	2" x 3"
CASE PACK	24 rolls, 250 labels per roll
CASE LBS. (CUBE)	10.86 (0.37)
LIST PRICE EACH	\$ 705.55

Laser Sheet



CASE CODE	SLL30
LABEL SIZE	1" x 2½" (Avery® 5160)
CASE PACK	100 sheets, 30 labels per sheet 8½" x 11" sheet size
CASE LBS. (CUBE)	2.42 (0.09)
LIST PRICE EACH	\$ 180.25



Camwear® Polycarbonate Food Pans

Store, transport and serve all in one pan. Camwear food pans are made from durable polycarbonate that will not crack, bend or dent. Precisely designed to Gastronorm GN specifications, with a large radius bottom to reduce food waste. At half the cost of stainless steel, Camwear pans keep contents as cold as metal pans with less condensation. Pans stack neatly without wedging or sticking.

Colors: Clear (135), White (148), Black (110). Except 18CW and 28CW available in Clear (135) only.
 Camwear pans are not recommended for steam table or microwave use. See H-Pan™ section for these high heat applications.
 Colander Pan is covered by U.S. Patent D 528,376.

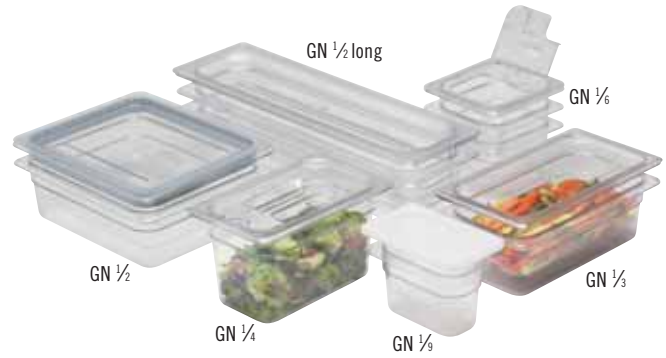

Uniform 1/2" (1.27 cm) flange ensures a smooth fit in prep tables and food bars.

Virtually unbreakable Camwear polycarbonate withstands temperatures from -40°F to 210°F (-40°C to 99°C).

Molded-in graduations in standard & metric for easy inventory management.



Won't react with food; minimizes potentially hazardous chemical or acidic reaction.

Non-stick smooth interior surface increases yields and promotes easy cleaning.

Textured bottoms resist scratching.



Cold Test

Tests prove Camwear food pans keep products as cold as stainless steel. Stainless may feel colder, but as these test results demonstrate, Camwear food pans keep products just as cold for just as long.

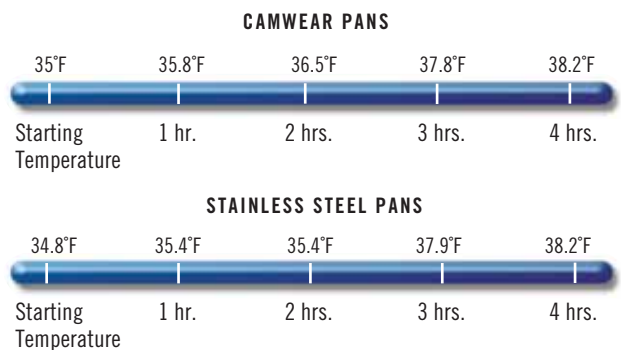

Camwear® Polycarbonate Food Pans



FULL SIZE

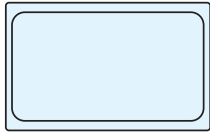

CONFIGURATIONS	PAN CODE	PAN DEPTH	APPROXIMATE CAPACITY	CASE LBS. (CUBE)	LIST PRICE EA.
GN 1/4 12 3/4" x 20 7/8" (32,5 x 53 cm)	12CW	2 1/2" (6,5 cm)	8.9 qt.	10.67 (1.30)	\$ 21.35
	14CW	4" (10 cm)	13.7 qt.	13 (1.67)	27.15
	16CW	6" (15 cm)	20.6 qt.	16.93 (2.09)	32.95
	18CW	8" (20 cm)	27.0 qt.	23 (2.78)	39.35
	10CWD	—	Drain Shelf	5.53 (0.35)	15.50

HALF SIZE LONG

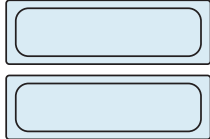

GN 1/2 Long 6 3/8" x 20 7/8" (16,2 x 53 cm)	22LPCW	2 1/2" (6,5 cm)	3.2 qt.	5.65 (0.46)	16.20
	24LPCW	4" (10 cm)	5.3 qt.	7.72 (0.92)	20.20
	20LPCWD	—	Drain Shelf	1.92 (0.19)	8.05

HALF SIZE

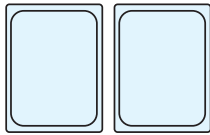

GN 1/2 10 7/16" x 12 3/4" (26,5 x 32,5 cm)	22CW	2 1/2" (6,5 cm)	4.1 qt.	5.57 (0.69)	11.85
	24CW	4" (10 cm)	6.3 qt.	7.03 (0.87)	14.75
	26CW	6" (15 cm)	9.4 qt.	9.44 (1.12)	18.95
	28CW	8" (20 cm)	12.4 qt.	11.81 (1.36)	24.10
	20CWD	—	Drain Shelf	2.29 (0.17)	7.20

ONE THIRD SIZE

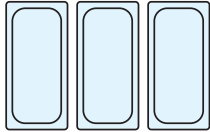

GN 1/3 6 15/16" x 12 3/4" (17,6 x 32,5 cm)	32CW	2 1/2" (6,5 cm)	2.5 qt.	4.15 (0.46)	8.90
	34CW	4" (10 cm)	3.8 qt.	5.50 (0.57)	12.25
	36CW	6" (15 cm)	5.6 qt.	6.77 (0.74)	14.30
	38CW	8" (20 cm)	7.3 qt.	9 (0.94)	18.30
	30CWD	—	Drain Shelf	1.29 (0.07)	6.65

QUARTER SIZE

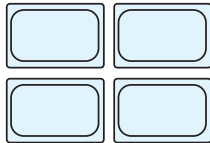

GN 1/4 6 3/8" x 10 7/16" (16,2 x 26,5 cm)	42CW	2 1/2" (6,5 cm)	1.8 qt.	2.97 (0.32)	9.00
	44CW	4" (10 cm)	2.7 qt.	3.74 (0.44)	10.60
	46CW	6" (15 cm)	3.9 qt.	5.25 (0.58)	12.25
	40CWD	—	Drain Shelf	0.88 (0.06)	5.55

ONE SIXTH SIZE



GN 1/6 6 3/8" x 6 15/16" (16,2 x 17,6 cm)	62CW	2 1/2" (6,5 cm)	1.1 qt.	2.05 (0.24)	6.55
	64CW	4" (10 cm)	1.6 qt.	2.61 (0.32)	7.40
	66CW	6" (15 cm)	2.4 qt.	3.36 (0.40)	9.90
	60CWD	—	Drain Shelf	0.57 (0.05)	2.95

ONE NINTH SIZE



GN 1/9 4 3/4" x 6 15/16" (10,8 x 17,6 cm)	92CW	2 1/2" (6,5 cm)	0.6 qt.	1.39 (0.16)	6.65
	94CW	4" (10 cm)	0.9 qt.	1.75 (0.20)	8.10
	90CWD	—	Drain Shelf	0.44 (0.04)	2.25

Case Pack for all Pans: 6. Lids listed on following page.
InStock Color: Clear (135).

Colors: Clear (135), White (148), Black (110). 18CW, 28CW and Drain Shelves available in Clear (135) only.

All Camwear food pans are made of FDA approved materials. All Camwear food pans are designed to CEN Gastronorm Standard EN 631-1.



Drain Shelves

- Supports products and promotes drainage.
- Available to fit all pan sizes.

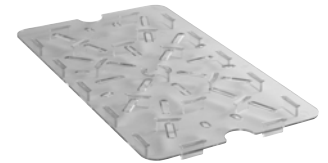

See next page for colanders.



Camwear® Polycarbonate Colander Pans

- Rinse, drain and store all in one pan.
- Liquids drain easily into the food pan below for enhanced food quality and reduced handling.
- Colanders simply lift out of the food pan for safe and quick disposal of liquids.
- Ideal for prepped produce, storing seafood on ice, and defrosting and storing meats and poultry.
- Camwear flat covers, covers with handles and notched covers with handles fit on pans with colanders.

Colander Pans are covered by U.S. Patent D 569,169 S.

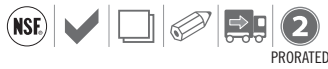

13CLRCW



Rinse



Drain



Store

CONFIGURATIONS	PAN CODE	COLANDER DEPTH	FITS CAMWEAR PAN DEPTH*	CASE LBS. (CUBE)	LIST PRICE EA.
GN 1/4 12 3/4" x 20 7/8" (32,5 x 53 cm)	13CLRCW	3" (7,6 cm)	4" (10 cm)	10.75 (1.52)	\$ 27.15
	15CLRCW	5" (12,7 cm)	6" (15 cm)	14.40 (2.0)	32.95
GN 1/2 10 7/16" x 12 3/4" (26,5 x 32,5 cm)	23CLRCW	3" (7,6 cm)	4" (10 cm)	5.0 (0.77)	14.75
	25CLRCW	5" (12,7 cm)	6" (15 cm)	7.80 (0.99)	18.95
GN 2/3 6 15/16" x 12 3/4" (17,6 x 32,5 cm)	33CLRCW	3" (7,6 cm)	4" (10 cm)	2.4 (0.53)	12.25
	35CLRCW	5" (12,7 cm)	6" (15 cm)	5.61 (0.69)	14.30
GN 3/4 6 3/8" x 6 15/16" (16,2 x 17,6 cm)	63CLRCW	3" (7,6 cm)	4" (10 cm)	2.25 (0.26)	7.40
	65CLRCW	5" (12,7 cm)	6" (15 cm)	3.09 (0.33)	9.90



Case Pack for all Pans: 6. Lids listed on following page. InStock Color: Clear (135).

* Fits this pan depth & deeper.

Camwear® Polycarbonate Lids



Flat Cover

Available in all pan sizes.



FITS PAN	LID CODE	DESCRIPTION	CASE LBS. (CUBE)	LIST PRICE EA.
GN ¼	10CWC	Flat Cover	7.9 (0.43)	\$ 18.00
12¾" x 20⅞" (32,5 x 53 cm)	10CWCH	Cover with Handle	8.48 (0.66)	18.00
	10CWCHN	Notched Cover w/Handle	8.47 (0.66)	18.00
	10CWGL	GripLid	10.68 (1.11)	37.95
	10SC	Seal Cover	6.56 (0.42)	11.10

Cover with Handle

Deep molded handle provides secure grip. Also available in Black to help block light, reducing discoloration of meats and cheeses. Helps maintain freshness.



GN ½ Long 6⅜" x 20⅞" (16,2 x 53 cm)	20LPCWC	Flat Cover	4.25 (0.24)	13.80
---	---------	------------	-------------	-------

Notched Cover with Handle

Easy access for ladles or spoons.



GN ½	20CWC	Flat Cover	1.81 (0.22)	9.40
10⅞" x 12¾" (26,5 x 32,5 cm)	20CWCH	Cover with Handle	3.83 (0.38)	9.40
	20CWCHN	Notched Cover w/Handle	3.88 (0.37)	11.00
	20CWL	FlipLid	5.40 (0.30)	14.85
	20CWLN	Notched FlipLid	5.40 (0.30)	14.85
	20CWGL	GripLid	5.73 (0.54)	26.35
	20SC	Seal Cover	2.96 (0.20)	6.45

Seal Cover

An economical option for light storage. Available in all pan sizes except half size long pans (22LPCW & 24LPCW).



GN ⅓	30CWC	Flat Cover	2.92 (0.13)	6.90
6⅝" x 12¾" (17,6 x 32,5 cm)	30CWCH	Cover with Handle	3.15 (0.31)	6.90
	30CWCHN	Notched Cover w/Handle	3 (0.30)	9.40
	30CWL	FlipLid	3.64 (0.21)	12.70
	30CWLN	Notched FlipLid	3.76 (0.21)	12.70
	30CWGL	GripLid	4.35 (0.38)	18.15
	30SC	Seal Cover	1.81 (0.13)	4.75

FlipLid®

Flip up lid to easily access contents. Food can be held without getting dried out, increasing yields. Reduces points of cross contamination.



GN ¼	40CWC	Flat Cover	2 (0.11)	6.25
6⅞" x 10⅞" (16,2 x 26,5 cm)	40CWCH	Cover with Handle	2.03 (0.21)	6.25
	40CWCHN	Notched Cover w/Handle	2 (0.21)	6.25
	40SC	Seal Cover	1.55 (0.11)	4.25

Notched FlipLid®

FlipLid with notch to rest spoon in contents with lid closed.



GN ⅓	60CWC	Cover	1.22 (0.07)	4.90
6⅞" x 6⅝" (16,2 x 17,6 cm)	60CWCH	Cover with Handle	1.42 (0.15)	5.40
	60CWCHN	Notched Cover w/Handle	1.42 (0.16)	5.40
	60CWL	FlipLid	2 (0.11)	7.20
	60CWLN	Notched FlipLid	2 (0.11)	7.20
	60CWGL	GripLid	2.38 (0.21)	14.90
	60SC	Seal Cover	0.86 (0.08)	3.25

GN ⅓	90CWC	Flat Cover	0.83 (0.05)	5.50
4¼" x 6⅝" (10,8 x 17,6 cm)	90WCN	Flat Notched Cover	0.83 (0.05)	5.50
	90SC	Seal Cover	0.60 (0.05)	2.90

Case Pack for all Lids: 6 InStock Color: Clear (135).

Color: Clear (135).

Seal Cover Color: White (148).

Cover with Handle Colors: Clear (135), Black (110).

FlipLids are covered by U.S. Patent D 420,849, D 422,838 & D 427,012.

GripLids are covered by U.S. Patent D 446,076 & Utility Patent 6,273,288 B1.



H-Pans™ High Heat Food Pans

Reduce handling and save expense with one pan that can go from prep to cooler to oven to steam table. H-Pans are designed to Gastronorm GN specifications. Unlike metal pans, H-Pans are safe for use in microwave ovens. Also ideal for heated carts, steam tables and chafing dishes. H-Pans have both standard and metric graduation markings to promote easy inventory management.

Colors: Amber (150), Black (110).
 H-Pans are made of FDA approved materials and are designed to CEN Gastronorm Standard EN 631-1.
 Amber color may vary.

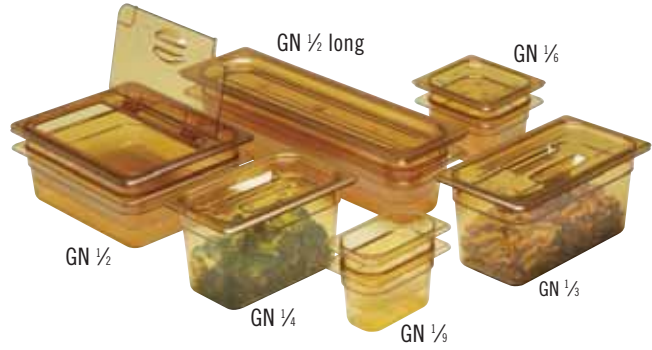

Uniform 1/2" (1,27 cm) flange ensures a smooth fit in prep tables and food bars.

Great for flash freezing, cooking and reheating.

Pans stack neatly, without wedging or sticking.



Made from FDA approved materials that withstand extreme temperatures from -40°F to 375°F (-40°C to 190°C).

Non-stick smooth interior surface increases yields and promotes easy cleaning.



H-Pans™ High Heat Food Pans



FULL SIZE

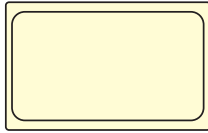

CONFIGURATIONS

GN 1/2
12 3/4" x 20 7/8"
(32,5 x 53 cm)

PAN CODE	PAN DEPTH	APPROXIMATE CAPACITY	CASE LBS. (CUBE)	LIST PRICE EA.
12HP	2 1/2" (6,5 cm)	8.9 qt.	10.87 (1.31)	\$ 50.70
14HP	4" (10 cm)	13.7 qt.	14.24 (1.77)	61.30
16HP	6" (15 cm)	20.6 qt.	19.50 (2.24)	79.70
10HPD	—	Drain Shelf	5.72 (0.37)	33.55

HALF SIZE LONG

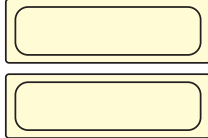

GN 1/2 Long
6 3/8" x 20 7/8"
(16,2 x 53 cm)

22LPHP	2 1/2" (6,5 cm)	3.2 qt.	5.83 (0.43)	36.05
24LPHP	4" (10 cm)	5.3 qt.	8.63 (0.98)	44.80
20LPHPD	—	Drain Shelf	1.92 (0.19)	16.75

HALF SIZE

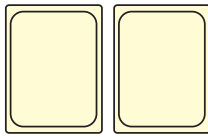

GN 1/2
10 1/16" x 12 3/4"
(26,5 x 32,5 cm)

22HP	2 1/2" (6,5 cm)	4.1 qt.	5.96 (0.66)	25.25
24HP	4" (10 cm)	6.3 qt.	8.40 (0.86)	32.85
26HP	6" (15 cm)	9.4 qt.	10 (1.10)	42.10
20HPD	—	Drain Shelf	2.44 (0.16)	15.05

ONE THIRD SIZE

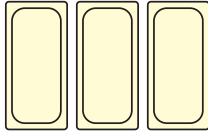

GN 1/3
6 15/16" x 12 3/4"
(17,6 x 32,5 cm)

32HP	2 1/2" (6,5 cm)	2.5 qt.	4.75 (0.45)	21.15
34HP	4" (10 cm)	3.8 qt.	5.58 (0.59)	27.40
36HP	6" (15 cm)	5.6 qt.	7.62 (0.75)	37.25
30HPD	—	Drain Shelf	1.36 (0.09)	11.30

QUARTER SIZE

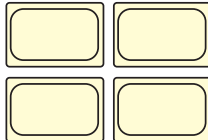

GN 1/4
6 3/8" x 10 1/16"
(16,2 x 26,5 cm)

42HP	2 1/2" (6,5 cm)	1.8 qt.	3.15 (0.34)	18.30
44HP	4" (10 cm)	2.7 qt.	4 (0.44)	22.60
46HP	6" (15 cm)	3.9 qt.	5.45 (0.58)	28.95
40HPD	—	Drain Shelf	1 (0.06)	11.30

ONE SIXTH SIZE



GN 1/6
6 3/8" x 6 15/16"
(16,2 x 17,6 cm)

62HP	2 1/2" (6,5 cm)	1.1 qt.	2.85 (0.24)	14.30
64HP	4" (10 cm)	1.6 qt.	3.01 (0.29)	17.25
66HP	6" (15 cm)	2.4 qt.	3.81 (0.39)	20.95
60HPD	—	Drain Shelf	0.60 (0.04)	5.80

ONE NINTH SIZE



GN 1/9
4 1/4" x 6 15/16"
(10,8 x 17,6 cm)

92HP	2 1/2" (6,5 cm)	0.6 qt.	1.45 (0.16)	10.80
94HP	4" (10 cm)	0.9 qt.	1.85 (0.20)	12.65
90HPD	—	Drain Shelf	0.45 (0.04)	4.30

Case Pack: 6 Lids listed on following page. InStock Color: Amber (150).

Colors: Amber (150), Black (110).
Drain Shelf Color: Amber (150).

H-Pans are made of FDA approved materials and are designed to CEN Gastronorm Standard EN 631-1. Amber color may vary.



Drain Shelf

- Supports product and promotes drainage.
- Available to fit all food pan sizes.



See next page for colanders.

H-Pan™ Colander Pans

- Colanders drain liquids and grease away from hot foods, improving food quality.
- Ideal for use in microwaves, steam tables and buffet lines.
- Reduces handling and improves food safety.
- H-Pan flat covers, covers with handles and notched covers with handles fit on pans with colanders.



Steam



Hold Hot Foods



Cook & Drain

CONFIGURATIONS	PAN CODE	COLANDER DEPTH	FITS H-PAN DEPTH*	CASE LBS. (CUBE)	LIST PRICE EA.
GN 1/4 12 3/4" x 20 7/8" (32,5 x 53 cm)	13CLRHP 15CLRHP	3" (7,6 cm) 5" (12,7 cm)	4" (10 cm) 6" (15 cm)	11.33 (1.52) 15.15 (2.0)	\$ 61.30 79.70
GN 1/2 10 7/16" x 12 3/4" (26,5 x 32,5 cm)	23CLRHP 25CLRHP	3" (7,6 cm) 5" (12,7 cm)	4" (10 cm) 6" (15 cm)	7 (0.83) 9.25 (1.06)	32.85 42.10
GN 3/8 6 15/16" x 12 3/4" (17,6 x 32,5 cm)	33CLRHP 35CLRHP	3" (7,6 cm) 5" (12,7 cm)	4" (10 cm) 6" (15 cm)	4.58 (0.53) 6.2 (0.71)	27.40 37.25
GN 1/2 6 3/8" x 6 15/16" (16,2 x 17,6 cm)	63CLRHP 65CLRHP	3" (7,6 cm) 5" (12,7 cm)	4" (10 cm) 6" (15 cm)	2.4 (0.29) 3.1 (0.34)	17.25 20.95

Case Pack for all Pans: 6. Lids listed on following page. **InStock Color:** Amber (150).
* Fits this pan depth & deeper.



H-Pan with Handles

- Full size 2 1/2" deep food pan with handles fits all leading manufacturers' hot holding bins.
- Two handles allow employees to reach the pan from either side of the unit for safe handling.
- Flat Cover, Cover with Handle and Notched Cover with Handle fit on pan.



12HPH

CONFIGURATIONS	PAN CODE	PAN DEPTH	APPROX. CAPACITY	CASE LBS. (CUBE)	LIST PRICE EA.
GN 1/4 12 3/4" x 20 7/8" (32,5 x 53 cm)	12HPH	2 1/2" (6,5 cm)	8.9 qt.	13.87 (1.54)	\$ 58.25

Case Pack: 6 **InStock Color:** Amber (150).

H-Pan™ High Heat Food Pan Lids



Flat Cover

Available in all pan sizes.



Cover with Handle

Deep molded handle gives secure grip.

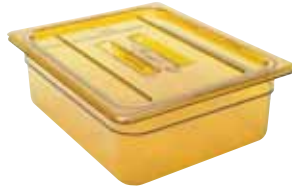

Notched Cover with Handle

Easy access for ladles or spoons.



Seal Cover

An economical option for light storage. Available in all pan sizes except half size long pans (22LPHP & 24LPHP).



FlipLid®

Flip up lid to easily access contents. Food can be held without getting dried out, increasing yields.



Notched FlipLid®

FlipLid with notch to rest spoon in contents with lid closed.



GripLid®

Molded-in polyurethane gasket on the lid grips the side of the food pan, reducing spills and points of cross-contamination.

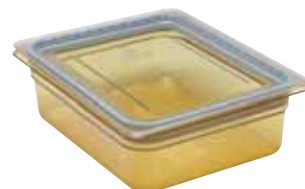

FITS PAN	LID CODE	DESCRIPTION	CASE LBS. (CUBE)	LIST PRICE EA.
GN ¼	10HPC	Flat Cover	9.4 (0.46)	\$ 45.50
12¾" x 20⅞" (32,5 x 53 cm)	10HPCH	Cover with Handle	8.90 (0.66)	45.50
	10HPCHN	Notched Cover w/Handle	10 (0.64)	45.55
	10CWGL	GripLid	10.68 (1.11)	37.95
	10SC	Seal Cover	6.56 (0.42)	11.10

GN ½ Long 6⅜" x 20⅞" (16,2 x 53 cm)	20LPHPC	Flat Cover	4.50 (0.23)	27.15
---	---------	------------	-------------	-------

GN ½	20HPC	Flat Cover	3.85 (0.21)	19.80
10⅞" x 12¾" (26,5 x 32,5 cm)	20HPCH	Cover with Handle	4.54 (0.36)	21.00
	20HPCHN	Notched Cover w/Handle	4.13 (0.33)	24.10
	20HPL	FlipLid	5.49 (0.31)	34.85
	20HPLN	Notched FlipLid	5.86 (0.31)	34.85
	20CWGL	GripLid	5.73 (0.54)	26.35
	20SC	Seal Cover	3.25 (0.22)	6.45

GN ½	30HPC	Flat Cover	2.60 (0.14)	14.75
6⅝" x 12¾" (17,6 x 32,5 cm)	30HPCH	Cover with Handle	2.89 (0.29)	16.70
	30HPCHN	Notched Cover w/Handle	2.88 (0.29)	16.70
	30HPL	FlipLid	4 (0.22)	24.90
	30HPLN	Notched FlipLid	3.88 (0.22)	24.90
	30CWGL	GripLid	4.35 (0.38)	18.15
	30SC	Seal Cover	1.81 (0.13)	4.75

GN ¾	40HPC	Flat Cover	2 (0.10)	12.00
6⅞" x 10⅞" (16,2 x 26,5 cm)	40HPCH	Cover with Handle	2.22 (0.20)	12.90
	40HPCHN	Notched Cover w/Handle	2.22 (0.20)	13.10
	40SC	Seal Cover	1.55 (0.11)	4.25

GN ¾	60HPC	Flat Cover	1.26 (0.08)	10.45
6⅞" x 6⅝" (16,2 x 17,6 cm)	60HPCH	Cover with Handle	1.42 (0.16)	10.45
	60HPCHN	Notched Cover w/Handle	1.5 (0.16)	10.45
	60HPL	FlipLid	2.26 (0.11)	14.25
	60HPLN	Notched FlipLid	2.04 (0.11)	14.25
	60CWGL	GripLid	2.38 (0.21)	14.90
	60SC	Seal Cover	0.86 (0.08)	3.25

GN ¾	90HPC	Flat Cover	1.85 (0.05)	7.20
4¼" x 6⅝" (10,8 x 17,6 cm)	90SC	Seal Cover	0.60 (0.05)	2.90

Case Pack for all Lids: 6 InStock Color: Amber (150).

Color: Amber (150).

Seal Cover Color: White (148).

GripLid Color: Clear (135).

Amber color may vary.

FlipLids are covered by U.S. Patent
D 420,849, D 422,838 & D 427,012 &
Patent 6,273,288 B1.

GripLids are covered by U.S. Patent
D 446,076.



Translucent Food Pans

- An economical choice for storing food.
- Translucent polypropylene material provides content visibility and high chemical resistance.
- Withstands temperature ranges from -40°F to 160°F (-40°C to 70°C).
- Non-stick smooth interior surface promotes easy cleaning.

Color: Translucent (190).

.....
 Graduation marks and capacities are approximate.

 Full Size (1/2) Translucent Food Pans are not designed for use in front loading carriers UPC400, UPCS400, UPC600, UPC800, UPC1200, UPC1600, UPCH400, UPCH800, UPCH1600, Camtherm® Carts or Combo Carts.

 Translucent Food Pans are made of FDA approved materials.

 Translucent Food Pans interstack with other Cambro Food Pans.

 Translucent Pans are not designed for steam table use.



Ideal for transporting in Cambro top loading carriers.
 (UPC100, UPCS140, 100MPC, UPC140, UPCS160, 240MPC, UPC160, UPCSS160)



Translucent seal covers protect food quality while eliminating the expense of plastic wrap. Available for all translucent food pan sizes.



Uniform 1/2" (1,27 cm) flange width ensures the right fit in prep tables and food bars.



Use Cambro StoreSafe® food rotation labels on translucent food pans to manage inventory and reduce waste.

Translucent Food Pans And Lids

FULL SIZE

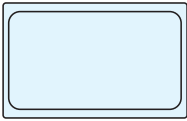

CONFIGURATIONS	PAN CODE	PAN DEPTH	APPROXIMATE CAPACITY	CASE LBS. (CUBE)	LIST PRICE EA.
1/4 12 3/4" x 20 7/8" (32,5 x 53 cm)	14PP	4" (10 cm)	13.7 qt.	8.75 (1.63)	\$ 16.15
	16PP	6" (15 cm)	20.6 qt.	12.52 (2.32)	20.65
	10PPD	—	Drain Shelf	4.18 (0.35)	9.20

HALF SIZE

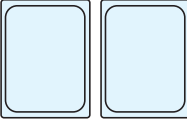

1/2 10 7/16" x 12 3/4" (26,5 x 32,5 cm)	24PP	4" (10 cm)	6.3 qt.	5.35 (0.85)	9.65
	26PP	6" (15 cm)	9.4 qt.	7.8 (1.10)	12.55
	20PPD	—	Drain Shelf	1.72 (0.16)	4.75

ONE THIRD SIZE

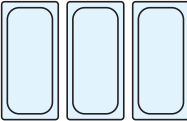

1/3 6" x 12 3/4" (17,6 x 32,5 cm)	34PP	4" (10 cm)	3.8 qt.	3.99 (0.98)	8.00
	36PP	6" (15 cm)	5.6 qt.	5 (0.76)	9.25
	30PPD	—	Drain Shelf	1.01 (0.08)	4.40

QUARTER SIZE



1/4 6 3/8" x 10 7/16" (16,2 x 26,5 cm)	44PP	4" (10 cm)	2.7 qt.	2.75 (0.45)	6.90
	46PP	6" (15 cm)	3.9 qt.	3.25 (0.52)	8.00
	40PPD	—	Drain Shelf	0.69 (0.06)	3.70

ONE SIXTH SIZE



1/6 6 3/8" x 6 15/16" (16,2 x 17,6 cm)	64PP	4" (10 cm)	1.6 qt.	2.0 (0.29)	5.15
	66PP	6" (15 cm)	2.4 qt.	2.7 (0.39)	6.75
	60PPD	—	Drain Shelf	3.75 (0.03)	2.45

ONE NINTH SIZE



1/9 4 1/4" x 6 15/16" (10,8 x 17,6 cm)	94PP	4" (10 cm)	0.9 qt.	1.32 (0.2)	5.80
	90PPD	—	Drain Shelf	0.37 (0.04)	1.70

Case Pack for all Pans: 6 InStock Color: Translucent (190).

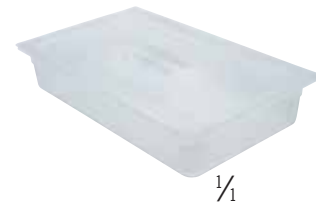

1/4



1/3



1/4



1/6

FITS PAN	LID CODE	DESCRIPTION	CASE LBS. (CUBE)	LIST PRICE EA.
1/4 12 3/4" x 20 7/8" (32,5 x 53 cm)	10PPCH	Cover with Handle	6 (0.55)	\$ 11.95
	10PPSC	Seal Cover	6.47 (0.80)	11.95

1/2 10 7/16" x 12 3/4" (26,5 x 32,5 cm)	20PPCH	Cover with Handle	2.99 (0.36)	8.20
	20PPSC	Seal Cover	3.50 (0.40)	7.30

1/3 6 15/16" x 12 3/4" (17,6 x 32,5 cm)	30PPCH	Cover with Handle	2.15 (0.28)	5.65
	30PPCHN	Notched Cover w/Handle	2 (0.28)	7.00
	30PPSC	Seal Cover	2.25 (0.28)	6.50

1/4 6 3/8" x 10 7/16" (16,2 x 26,5 cm)	40PPCH	Cover with Handle	1.56 (0.20)	5.55
	40PPSC	Seal Cover	1.75 (0.20)	5.25

1/6 6 3/8" x 6 15/16" (16,2 x 17,6 cm)	60PPCH	Cover with Handle	1.62 (0.16)	4.80
	60PPCHN	Notched Cover w/Handle	1.07 (0.16)	5.25
	60PPSC	Seal Cover	1.18 (0.14)	4.80

1/9 4 1/4" x 6 15/16" (10,8 x 17,6 cm)	90PPC	Flat Cover	0.65 (0.05)	4.15
	90PPSC	Seal Cover	0.8 (0.10)	4.15

Case Pack for all Lids: 6 InStock Color: Translucent (190).

Color: Translucent (190).

All translucent food pans are made of FDA approved materials.



Drain Shelf
Available for all food pan sizes.



Cover with Handle
Available for all food pan sizes except 1/9.



Notched Cover with Handle
Available for 1/3 and 1/6 food pans.



Seal Cover
Available for all food pan sizes.



Flat Cover
Only available for 1/9 food pans.

ColdFest® Gastronorm Pans, Crocks, Covers & Pumps



- Keeps contents chilled at or below HACCP guidelines of 41°F (4°C) without the use of messy ice.
- Freeze for eight hours or overnight before filling with pre-chilled product.
- Half and third-size pans hold contents cold for up to eight hours. Sixth size pans and crocks hold contents cold for up to six hours.
- Conforms to Gastronorm exterior dimensions to fit standard food bars or make tables.
- Stackable to save space when freezing and storing.
- Can be used for direct food contact with all types of food products.

Colors: Black (110), White (148).
Flat Cover Color: Clear (135).
Seal Cover Color: White (148).
Pump with Cover Color: Clear (135).

Suggested holding times are based on tests with ambient room conditions of up to 74°F (23°C).

ColdFest is covered under U.S. Patent D 419,364.

* Pumps and Round Covers are Not NSF Listed.



Ideal in Cambro Salad Bars or to chill condiments and creamers.

Pans / Crock



CODE	26CF	36CF	66CF	CFR18
CONFIGURATIONS	GN ½ – 10¼" x 12¼"	GN ½ – 6 ¹¹ / ₁₆ " x 12¼"	GN ½ – 6¾" x 6¾"	Dia. 6 ¹³ / ₁₆ "
DEPTH	6"	6"	6"	6¾"
APPROX. CAPACITY	6.5 qt.	3.7 qt.	1.5 qt.	1.7 qt.
CASE LBS. (CUBE)	7.23 (0.52)	4.86 (0.34)	2.67 (0.18)	3 (0.20)
LIST PRICE EACH	\$ 57.55	\$ 43.25	\$ 29.45	\$ 31.95

Case Pack: 1 InStock Color: White (148).



ColdFest Food Pans are made with high-impact resistant ABS shells and non-toxic refrigerant gel cores.

Covers



CODE	20CFC	30CFC	60CFC	CFRC18*	CFRSC18
DESCRIPTION	Flat Cover	Flat Cover	Flat Cover	Flat Cover	Seal Cover
FITS COLDVEST	GN ½	GN ½	GN ½	Crock	Crock
CASE LBS. (CUBE)	1.50 (0.13)	1.03 (0.08)	0.50 (0.04)	0.45 (0.03)	0.25 (0.04)
LIST PRICE EACH	\$ 14.55	\$ 12.15	\$ 6.50	\$ 17.80	\$ 5.30

Case Pack: 2 InStock Color: Clear (135).

Pumps with Covers



CODE	CFPSRC10*	CFPMRC10*	CFPFR10*
DESCRIPTION	Standard Pump dispense 1oz. portions	Maxi Pump for chunky condiments	Fixed Nozzle Pump for controlled dispensing
DIMENSIONS W x D x H	7¼" x 9" x 11¼"	7¼" x 10¼" x 12¾"	7¼" x 11½" x 11¼"
CASE LBS. (CUBE)	0.75 (0.11)	0.6 (0.11)	20.2 (0.11)
LIST PRICE EACH	\$ 15.90	\$ 37.85	\$ 37.50

Case Pack: 1



Ingredient Bins & Camcrisper®

Ingredient Bins

- Store bulk dry ingredients such as flour and grain.
- Hygienic clear sliding lid reduces handling and allows for quick content identification.
- Bin made of FDA-accepted material so no liners are needed.
- Designed to fit under standard work tables.

Camcrisper

- A self-contained system for storing, washing and transporting bulk produce.
- Prevents cross contamination and minimizes unnecessary handling.
- Transfer dry produce out of cartons into bin, cover and roll into cooler for safe storage.
- Wash and rinse produce for easy and safe prep.

3" Casters: 2 fixed, 2 swivel.

Bin Color: White (148).

Cover Color: Clear (135).

Scoops sold separately. S-Hook included.



Casters feature wide wheels for excellent stability and weight bearing capability.



Now with Sliding Lid.

CODE	IBS20	IBS27	IBS37	IBSF27
DIMENSIONS W x L x H	13" x 29½" x 28"	16¼" x 29½" x 28"	21½" x 29½" x 28"	13" x 30¼" x 28½"
CAPACITY	21 gal.	27 gal.	37 gal.	26.7 gal.
CUBIC FEET	2.87	3.98	5.55	3.56
LOAD CAPACITY (SUGAR)	170 lbs.	226 lbs.	314 lbs.	216 lbs.
LOAD CAPACITY (FLOUR)	140 lbs.	150 lbs.	225 lbs.	150 lbs.
CASE LBS. (CUBE)	28 (6.56)	31 (8.18)	28 (10.63)	28.5 (6.91)
LIST PRICE EACH	\$ 365.00	\$ 375.00	\$ 400.00	\$ 390.00

Case Pack: 1 InStock Color: White (148).



CODE	IB32	IB36	IB44	CC32 (Camcrisper)
DIMENSIONS W x L x H	22" x 24" x 23"	15¼" x 29½" x 29"	18½" x 29½" x 29"	22" x 24" x 23"
CAPACITY	32 gal.	34 gal.	42.5 gal.	32 gal.
CUBIC FEET	4.35	4.54	5.69	4.28
LOAD CAPACITY (SUGAR)	215 lbs.	252 lbs.	320 lbs.	24 lettuce heads (unfinished)
LOAD CAPACITY (FLOUR)	160 lbs.	180 lbs.	230 lbs.	42 lettuce heads (finished)
CASE LBS. (CUBE)	27.75 (7.5)	28.46 (7.64)	29.36 (9.31)	28.67 (7.67)
LIST PRICE EACH	\$ 390.00	\$ 400.00	\$ 405.00	\$ 580.00

Case Pack: 1

Camwear® Polycarbonate Scoops & Measuring Cups



Camwear Scoops

Color: Clear (135).



- Virtually unbreakable Camwear polycarbonate will not dent, chip or rust.
- Molded-in sure grip handle includes a hole for hanging.
- Ideal for use with Cambro Ice Caddies and Ingredient Bins.



CODE	APPROX. CAPACITY	CASE PACK	CASE LBS. (CUBE)	LIST PRICE EA.
SCP6CW	6 oz.	12	2.26 (0.20)	\$ 6.70
SCP12CW	12 oz.	12	2.90 (0.28)	7.25
SCP24CW	24 oz.	12	3.88 (0.43)	9.20
SCP64CW	64 oz.	6	4.15 (0.67)	13.10

InStock Color: Clear (135).

Camwear Measuring Cups

Color: Clear (135).



- Externally marked graduations are molded in and imprinted in red for American standard and blue for metric for easy measurement.
- Durable, virtually unbreakable Camwear polycarbonate will not dent, ensuring an accurate measurement every time.
- Molded-in handle will not break off.



CODE	CAPACITY	CASE PACK	CASE LBS. (CUBE)	LIST PRICE EA.
25MCCW	1 cup (dry measure)	12	1.75 (0.29)	\$ 6.55
50MCCW	1 pt.	12	4.79 (0.65)	12.20
100MCCW	1 qt.	12	6.75 (1.08)	13.70
200MCCW	2 qt.	12	10.60 (2.24)	18.90
400MCCW	4 qt.	1	1.56 (0.44)	20.50

InStock Color: Clear (135).



MENU	
Salad	\$5.50
Fruit	2.40
Juice	1.99
Soda	1.49
Water	1.39

CRUISING
CAFE

MERCHANDISING EQUIPMENT

Versa Food Service System



The Versa Food Service System provides custom design without the custom price. This non-electric, completely portable system goes anywhere and keeps food cold for hours with either ColdFest® pans or Buffet Camchillers®. Whether it's space considerations, frequent menu changes or merchandising requirements, the Versa Food Service System offers unequalled versatility.

- All components are fully compliant with NSF requirements.
- Countless configurations to fit any food service need.
- All-weather material is durable and easy to clean.
- Ergonomic, molded-in handles on both sides ensure easy maneuvering.
- One person can set-up or knock-down the sneeze guards and tray rails for transport or storage in only 30 seconds.
- Easily fits through a standard 3' (91,5 cm) doorway with the sneeze guards and tray rails knocked down. Knocked down width: 32½" (83 cm).
- Drain faucet can be connected to a hose for drainage and easy cleaning.



Add an end table to a Versa Food Bar® or Versa Work Table to hold trays, plates or condiments.

Versa Cart

The Cart includes an adjustable shelf, standard lockable drawer and a front panel for convenient electrical access. Tray rails easily adjust to a lower height.

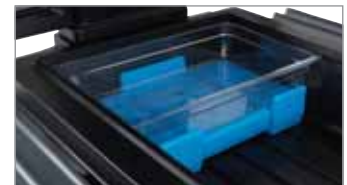

Versa Straight Connector and Versa Corner Connector

Easily and safely attach multiple components together to create a contiguous system and maximize space and merchandising options.

Versa Cart Keyboard Tray

Convenient, pull-out keyboard tray improves ergonomics and fits inside the standard lockable drawer.

Buffet Camchillers®

Extend safe, cold holding time without ice. Dual-sided Buffet Camchillers hold 2½" (6,5 cm) and 4" (10 cm) pans. Fits in the Versa Food Bar®, Versa Work Table and Table Top Food Bars.

Versa Food Service System

Whether you're looking to maximize space, improve traffic flow, add merchandising space or create an upscale salad bar, the Versa Food Service System has you covered.



Versa Food Bar®



Versa Work Table

- Perfect for a prep table, display, self-serve station or back bar.
- Attach a Work Table to a Food Bar to merchandise snacks and beverages.
- Matching well covers are included with each Versa Work Table.



Standard height model.

Versa Bar and Versa Work Table Ultra Series

- Now available with two secure storage cabinets that can hold up to of 50 lbs. (22,7 Kg) per compartment of non-perishable items.
- Preferred Salad Bar of:
 - United Fresh Produce Association's *A Salad Bar in Every School™*
 - *Let's Move Salad Bars to Schools* Campaign



Storage dimensions:
18"H x 17½"W x 21½"D per cabinet.
Each cabinet is 3.92 cu. ft. (0,11 M³).

Versa Food Service System

CODE	DESCRIPTION	OVERALL EXTERIOR DIMENSIONS L x W x H	FULL PAN SIZE CAPACITY	WELL INTERIOR DIMENSIONS L x W x H	CASE LBS. (CUBE)	LIST PRICE EA.
Versa Food Bars® - Standard Height						
VBR5	5' with Standard Casters	69" x 42½" x 62¾"	4	52⅝" x 21" x 7⅞"	184 (39.12)	\$ 2,850.00
VBRU5	5' with Standard Casters and Storage	69" x 42½" x 62¾"	4	52⅝" x 21" x 7⅞"	260 (58.5)	3,640.00
VBRHD5	5' with Heavy Duty Casters	69" x 42½" x 62¾"	4	52⅝" x 21" x 7⅞"	194.9 (39.12)	3,080.00
VBRUHD5	5' with Heavy Duty Casters and Storage	69" x 42½" x 62¾"	4	52⅝" x 21" x 7⅞"	269.5 (58.5)	3,870.00
VBR6	6' with Standard Casters	82" x 42½" x 62¾"	5	65⅞" x 21" x 7⅞"	219 (45.97)	2,970.00
VBRU6	6' with Standard Casters and Storage	82" x 42½" x 62¾"	5	65⅞" x 21" x 7⅞"	274 (75)	3,885.00
VBRHD6	6' with Heavy Duty Casters	82" x 42½" x 62¾"	5	65⅞" x 21" x 7⅞"	229.5 (45.97)	3,200.00
VBRUHD6	6' with Heavy Duty Casters and Storage	82" x 42½" x 62¾"	5	65⅞" x 21" x 7⅞"	283.5 (75)	4,115.00
Versa Food Bars - Low Height						
VBRL5	5' with Standard Casters	69" x 42½" x 55¾"	4	52⅝" x 21" x 7⅞"	175 (39.12)	2,850.00
VBRLHD5	5' with Heavy Duty Casters	69" x 42½" x 55¾"	4	52⅝" x 21" x 7⅞"	181.9 (39.12)	3,080.00
VBRL6	6' with Standard Casters	82" x 42½" x 55¾"	5	65⅞" x 21" x 7⅞"	202.5 (45.97)	2,970.00
VBRLHD6	6' with Heavy Duty Casters	82" x 42½" x 55¾"	5	65⅞" x 21" x 7⅞"	213 (45.97)	3,200.00
Versa Work Tables - Standard Height						
VBRT5	5' with Standard Casters	69" x 27" x 36¼"	4	52⅝" x 21" x 7⅞"	125 (24.03)	2,110.00
VBRUT5	5' with Standard Casters and Storage	69" x 27" x 36¼"	4	52⅝" x 21" x 7⅞"	181.5 (47.65)	2,460.00
VBRTHD5	5' with Heavy Duty Casters	69" x 27" x 36¼"	4	52⅝" x 21" x 7⅞"	135.5 (24.03)	2,340.00
VBRUTHD5	5' with Heavy Duty Casters and Storage	69" x 27" x 36¼"	4	52⅝" x 21" x 7⅞"	190.5 (47.65)	2,690.00
VBRT6	6' with Standard Casters	82" x 27" x 36¼"	5	65⅞" x 21" x 7⅞"	142.5 (28.24)	2,235.00
VBRUT6	6' with Standard Casters and Storage	82" x 27" x 36¼"	5	65⅞" x 21" x 7⅞"	195.5 (55.96)	2,570.00
VBRTHD6	6' with Heavy Duty Casters	82" x 27" x 36¼"	5	65⅞" x 21" x 7⅞"	153 (28.24)	2,465.00
VBRUTHD6	6' with Heavy Duty Casters and Storage	82" x 27" x 36¼"	5	65⅞" x 21" x 7⅞"	204.5 (55.96)	2,800.00
Versa Work Tables - Low Height						
VBRTL5	5' with Standard Casters	69" x 27" x 29¼"	4	52⅝" x 21" x 7⅞"	112 (24.03)	2,015.00
VBRTLHD5	5' with Heavy Duty Casters	69" x 27" x 29¼"	4	52⅝" x 21" x 7⅞"	122.5 (24.03)	2,245.00
VBRTL6	6' with Standard Casters	82" x 27" x 29¼"	5	65⅞" x 21" x 7⅞"	129.5 (28.24)	2,140.00
VBRTLHD6	6' with Heavy Duty Casters	82" x 27" x 29¼"	5	65⅞" x 21" x 7⅞"	140 (28.24)	2,370.00

Case Pack: 1

CODE	DESCRIPTION	OVERALL EXTERIOR DIMENSIONS L x W x H	CASE LBS. (CUBE)	LIST PRICE EA.
Versa Cart				
VCSWR	With Dual Tray Rails and Standard Casters	52¾" x 32¼" x 43"	127 (37.28)	\$ 2,320.00
VCSWRHD	With Dual Tray Rails and Heavy Duty Casters	52¾" x 32¼" x 43"	138.4 (37.28)	2,550.00
VCS	With Standard Casters and no Tray Rails	32" x 32¼" x 43"	117.5 (37.28)	2,255.00
VCSHD	With Heavy Duty Casters and no Tray Rails	32" x 32¼" x 43"	128.8 (37.28)	2,485.00
Connectors				
VBRC	Straight Connector - Food Bar to Food Bar	27" x 19" x 4¼"	10.58 (1.46)	170.00
VBRC90	Corner Connector - Food Bar to Food Bar	36" x 36" x 4¼"	21.26 (3.66)	285.00
VCS32CNT	Straight Connector - Cart to Standard Height Food Bar / Work Table	27" x 20⅝" x 3¼"	10.75 (1.20)	295.00
VCSCNL	Straight Connector - Cart to Low Height Food Bar / Work Table	27" x 20⅝" x 8½"	14.62 (2.56)	355.00

Case Pack: 1

Versa Food Bar, Versa Work Table, Versa Cart Colors:

Made to order items not carried in stock, non-returnable.

Tray Rail and End Table Colors Only:



InStock Color:
Black (110)



*Bronze (146)



*Hot Red (158)



*Navy Blue (186)



*Kentucky Green (519)



InStock Color:
Granite Gray (191)



**Sandstone (614)

* Made to order colors for Versa Food Bar, Versa Work Table, Versa Cart, Tray Rail and End Table. ** Made to order color for Tray Rail and End Table only.

Food Bar Accessories

Every Accessory You Need

- Crock and Salad Bowl Holders highlight and organize salads, condiments and dressings.
- Tray Rails offer convenience for your patrons.

See Camwear® Food Pans and Crocks section for more information.

Versa Food Bar®, Work Table and Cart: Black (110) receive the tray rails and end table in Granite Gray (191) for a standard order.

Bronze (146) receive tray rails and end table in Sandstone (614) for a standard order.

Made to Order Colors: Versa Food Bar, Work Table, Cart Tray Rails and End Table made to order colors are listed on previous page.

Connector Colors: Black (110), Bronze (146), Hot Red (158), Navy Blue (186), Kentucky Green (519).

Vinyl Cover Color: Opaque (000).

Sign Holder Color: Clear (152).

Buffet Camchiller® Color: Cold Blue (159).

Divider Bar Colors: White (148), Clear (152).

Well Cover Colors: Black (110), Bronze (146), Hot Red (158), Navy Blue (186), Kentucky Green (519).

Keyboard Tray Color: Black (110).

Crock, Salad Bowl Holders Colors: White (148), Granite Gray (191), Sandstone (614)

Versa Food Bar is covered under U.S. Patent D 615,323 S and D 620,730. All other parts patent pending. Versa Cart is covered under U.S. Patent D 653,830 S. Buffet Camchiller is covered under U.S. Patent D 618,476 S.

* Items are not NSF Listed

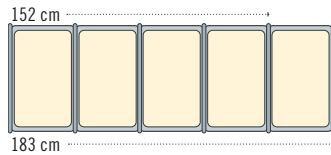

- 6 ft. models hold 5 full size Pans with Divider Bars.
- 5 ft. models hold 4 full size Pans with Divider Bars.

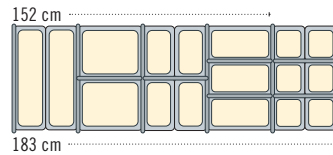

- Fractional Size Pans can be used in many variations with Divider Bars. Mix and match sizes to fit your needs.

Two Salad Bowl Holder models available, SBH18 and SBH15. Crock Holder, CPH3, holds 1.5 and 2.7 qt. crocks.

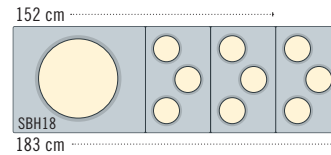

- 6 ft. models hold a Salad Bowl Holder and 3 ea. Crock Holders.
- 5 ft. models hold a Salad Bowl Holder and 2 ea. Crock Holders.

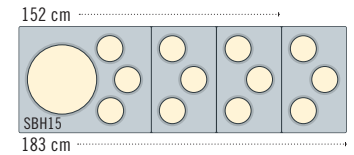

CODE	DESCRIPTION	OVERALL EXTERIOR DIMENSIONS	CASE LBS. (CUBE)	CASE PACK	LIST PRICE EA.
VBRR5	Tray Rail for 5' - Versa Food Bar / Work Table	53" L x 11½" W x 4½" H	12.66 (1.81)	1	\$ 402.00
VBRR6	Tray Rail for 6' - Versa Food Bar / Work Table	66" L x 11½" W x 4½" H	15.57 (2.31)	1	424.00
VCS32R	Tray Rail for - Versa Cart	28" L x 11½" W x 5" H	8.06 (1.10)	1	330.00
VBRTBL	End Table For Versa Food Bar and Work Table	27" L x 22" W x 4½" H	10.00 (1.05)	1	430.00
LED54LIGHTPKG*	Lighting Accessory Kit for Versa Food Bar	54" L	2.86 (0.57)	1	480.00
VBRCVR5*	Vinyl Cover for 5' Versa Food Bar	73" L x 43½" W x 46" H	8 (0.25)	1	310.00
VBRCVR6*	Vinyl Cover for 6' Versa Food Bar	83" L x 43½" W x 46" H	9 (0.25)	1	340.00
VBRTCVR5*	Vinyl Cover for 5' Versa Work Table	70" L x 33½" W x 21" H	4 (0.25)	1	165.00
VBRTCVR6*	Vinyl Cover for 6' Versa Work Table	83" L x 33½" W x 21" H	5 (0.25)	1	180.00
VCSCVR*	Vinyl Cover for Versa Cart	42" L x 33" W x 36" H	3.5 (0.25)	1	165.00
VBRSHTS*	Versa Food Bar Sign Holder	36" L x 6" W x 9¼" H	9 (3.34)	1	265.00
DIV12	12" Divider Bars	12¼" L	0.5 (0.02)	3	4.00
DIV20	20" Divider Bars	20⅞" L	1.03 (0.10)	3	9.55
CPH3	Crock Holder Holds 1.5 & 2.7 qt	12¼" L x 20⅞" W	2.2 (0.19)	1	65.00
SBH15	Salad Bowl Holder Holds a 15" Bowl and 3 Crocks	25¼" L x 20⅞" W	4 (0.39)	1	65.00
SBH18	Salad Bowl Holder Holds an 18" Bowl	25¼" L x 20⅞" W	4 (0.39)	1	65.00
CPB1220	Buffet Camchiller	18½" L x 12½" W x 4" H	10.82 (0.62)	1	185.00
VBRWC	Versa Well Cover for Versa Food Bar/Work Table	20⅞" L x 13" W x 2" H	3.72 (0.39)	1	126.00
VCS32KEYT	Versa Cart Keyboard Tray	20⅞" L x 10⅞" W x 2" H	2.64 (0.39)	1	59.00

Versa Food Bar Well Cover InStock Color: Black (110).

Table Top Food Bars, Buffet Bars & Sneeze Guards



Table Top Food Bars

- Turn a 4'-6' (122-183 cm) table into a double-sided self service buffet or beverage station.
- Thick, foam-insulated well keeps food cold for hours with Buffet Camchillers® or ice.
- Drain plug allows for quick and easy clean-up.

Buffet Bars

- Ideal for holding snacks and cold beverages.
- The Buffet Bar with Sneeze Guard is perfect for single-sided, self-serve buffets.



BUF48 and FSG480 can be shipped by parcel carrier.



4FBRTT Table Top Food Bar



FSG480 Sneeze Guard

The Free Standing Sneeze Guard is the perfect showcase for salad or dessert items.



BUF48 Buffet Bar Base

Merchandises soft drinks on ice to increase beverage sales.



BBR480 Buffet Bar with Sneeze Guard

CODE	OVERALL EXTERIOR DIMENSIONS	FULL SIZE PAN CAPACITY	WELL INTERIOR DIMENSIONS	CASE LBS. (CUBE)	LIST PRICE EA.
Table Top Food Bars					
	L x W x H		L x W x D		
6FBRTT	71½" x 33¼" x 27"	5	62⅞" x 20⅞" x 6½"	104 (17.57)	\$ 1,590.00
5FBRTT	63½" x 33¼" x 27"	4	50⅞" x 20⅞" x 6½"	92.2 (16.26)	1,470.00
4FBRTT	51" x 33¼" x 27"	3	37¼" x 20⅞" x 6½"	81.45 (16.26)	1,335.00
Buffet Bars					
	L x W x H		L x W x D		
BUF72	67½" x 24" x 7"	5	62⅞" x 20⅞" x 5"	28.67 (6.61)	475.00
BUF48	41⅜" x 24" x 7"	3	37¼" x 20⅞" x 5"	20.31 (3.80)	410.00
Free Standing Sneeze Guards					
	L x W x H		L x W		
FSG720	73⅞" x 16½" x 24½"		67½" x 15¼"	33.50 (6.80)	460.00
FSG480	48" x 16½" x 24½"		42" x 15¼"	25 (4.30)	360.00
Buffet Bars w/Sneeze Guard					
	L x W x H		L x W x D		
BBR720	73⅞" x 24⅞" x 24½"	5	62⅞" x 20⅞" x 5"	67 (20.74)	905.00
BBR480	48" x 24⅞" x 24½"	3	37⅞" x 20⅞" x 5"	50 (10.88)	760.00

Made to Order Colors: Black (110), Navy Blue (186), Kentucky Green (519), Hot Red (158). Case Pack: 1

www.cambro.com

1.800.833.3003

Sample Food Bar Set-ups

Visit www.cambro.com/schools for food bar resources, best practices and free posters.



5 ft. (152 cm) model



6 ft. (183 cm) model



Fresh Food Bars Pre-packaged Breakfast



Rainbow Theme

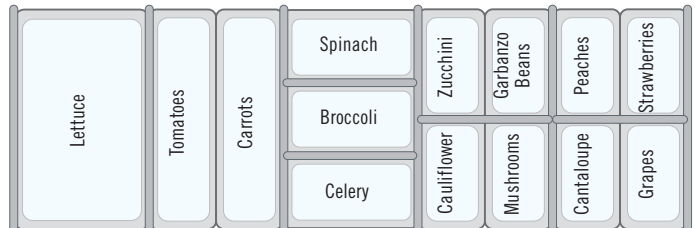

Fresh Food Bars Pre-packaged Lunch



Taco Theme

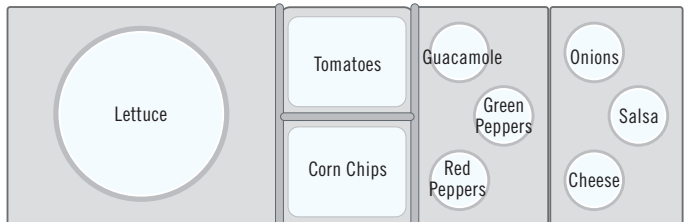

Chili Theme



Burger Theme

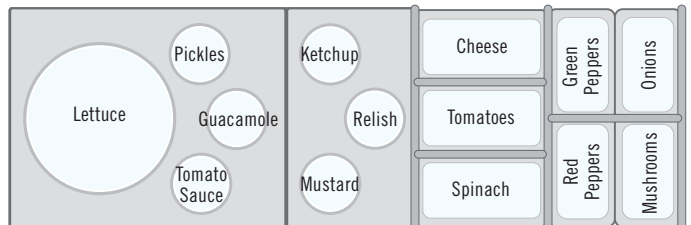





CamKiosk® System – Every Event Or Location Is An Opportunity For Profits.

- Build sales off premise and in non-traditional locations.
- Two insulated food storage cabinets maintain safe hot or cold food and/or beverage temperatures for hours.
- Use Optional Well Covers to cover food pan wells and increase countertop space.
- Durable, all-weather polyethylene exterior with foam insulation will not crack, dent, bubble, chip, rust or break.
- Heavy duty 6" (15,2 cm) casters roll smoothly from kitchen to location then lock in place.



KVC854U
Cart w/4 pan wells & umbrella.

CamKiosk® Carts



Telescoping poles enable canopy to lower 12" for quick and easy storage.



KVC854C Cart w/4 pan wells & canopy.



Cart Colors Canopy Color

186	Navy Blue	157	Beige
158	Hot Red		

Cart Colors Canopy Color

191	Granite Gray	519	Kentucky Green
192	Granite Green		Umbrella Color
519	Kentucky Green		Beige/Kentucky Green
426	Black Base with Granite Gray Top & Doors		

Personalize your CamKiosk Cart to promote your brand.

Canopy Trim and Top Panel

Call 714-230-4125 for a quote.

Front Display Panel

(Cruising Café® panel standard)

Set Up Charge per Panel \$ 135.00

Charge NET per Color 10.00

CODE	FULL SIZE PAN WELLS	OVERALL DIMENSIONS L x W x H	CASE LBS. (CUBE)	LIST PRICE EA.
CamKiosk Carts				
KVC854	4	85½" x 33½" x 70½"	302 (64.6)	\$ 7,115.00
KVC854C	4	85½" x 33½" x 94"	364 (90.899)	9,705.00
KVC854U	4	85½" x 60½" x 99"	345 (66.0)	7,585.00
KVC856	6	85½" x 33½" x 70½"	305 (64.6)	7,115.00
KVC856C	6	85½" x 33½" x 94"	349 (90.4)	9,705.00
KVC856U	6	85½" x 60½" x 99"	343.2 (72.54)	7,585.00

C: Canopy U: Umbrella

Holding Capacity Per Compartment

Two holding cabinets store hot or cold food in Gastronorm Food Pans with Covers.

12 GN ½ full size 2½" deep pans or
8 GN ¼ full size 4" deep pans or
6 GN ¼ full size 6" deep pans or
4 GN ¼ full size 8" deep pans or
8 each 2025 Camtrays
8 each 3253 Camtrays



Conveniently located, lockable cash box (included) can also be kept in dry storage compartment.



Camchillers® keep packaged foods cold during transport and service. Place directly on top of food pan wells or at the top of the CamKiosk insulated holding cabinet.



Bridge connector joins CamKiosk and hand sink to create greater contiguous work space and under-counter storage.



4 well top with work space



6 well top

Bridge Connector & Well Cover Colors:

Black (110), Hot Red (158), Navy Blue (186), Kentucky Green (519), Granite Gray (191), Granite Green (192).

6" Casters: 2 fixed, 2 swivel, 2 with brake.

Cutting Board Color: White (148).

Camchiller Color: Cold Blue (159).

ThermoBarrier Color: Slate Blue (401).



Camchiller & ThermoBarrier

CODE	DESCRIPTION	DIMENSIONS L x W x H	CASE LBS. (CUBE)	CASE PACK	LIST PRICE EA.
Optional Accessories					
CB1220	Cutting Board	21" x 13½" x ½"	4 (0.31)	1	\$ 42.00
CP814	8" x 14" Camchiller®	1½" x 8" x 14"	3.8 (0.19)	1	67.00
CP1210	Camchiller GN Half size	10¾" x 12¾" x 1½"	3.8 (0.18)	1	67.00
CP1220	Camchiller GN Full size	20¼" x 12¾" x 1½"	8.15 (0.32)	1	130.00
KMC24	Bridge Connector	32¼" x 23" x 38¾"*	33.2 (5.52)	1	715.00
WCR1220	Well Cover	21" x 13" x 2"	5 (0.55)	1	99.00
1600DIV	ThermoBarrier® Insulated Shelf	20¾" x 13¾" x 1½"	6.17 (0.55)	2	75.00

* Assembled dimensions for KMC24.

www.cambro.com

CamKiosk® Hand Sink Cart, Work Station & Equipment Stand

Hand Sink Cart

- Self-contained, electric hand washing system can be used alone or with CamKiosk Cart.
- Run hot and cold water for up to 70 hand washings.
- Includes: double sink, two 5-gallon (19 L) fresh water tanks, two 7½-gallon (28,5 L) waste-water bins, hand soap dispenser and paper towel roll holder.
- Durable polyethylene will not crack, dent, bubble, chip or break.
- Hand Sink Cart is designed for hand washing. It contains no filter for purifying water for drinking.
- Faucet is compliant with lead-free regulations.

Colors: Granite Gray (191), Granite Green (192), Navy Blue (186), Hot Red (158), Kentucky Green (519), Black Base with Granite Gray Top & Doors (426).

6" Casters: 2 fixed, 2 swivel, 2 with brake.

Hand Sink Cart is covered by U.S. Patent D 409,732 & by Patent 6,173,458 B1.

† 220 volt model includes CEE7 type Euro plug.



Water pump only.
Hand Sink Water Pump, UL & CE approved.



Water heater and water pump draw a maximum of 11.25 amps and 0.7 amps, respectively. Hand Sink Cart electrical system runs on an average 10 amps.

ADA faucet available. Contact Cambro Customer Service for information.



CODE	VOLTAGE	DIMENSIONS L x W x H	CASE LBS. (CUBE)	LIST PRICE EA.
KSC402	110	40 ⁹ / ₁₆ " x 32 ¹ / ₂ " x 45 ¹ / ₂ "	209.97 (39.41)	\$ 5,170.00
KSC402220†	220	40 ⁹ / ₁₆ " x 32 ¹ / ₂ " x 45 ¹ / ₂ "	209.97 (39.41)	5,170.00

Case Pack: 1

Work Station

- Use to merchandise menu items, additional work space or to complete sales transactions.
- Large storage cabinet below is perfect for holding supplies.
- Extremely durable all-weather polyethylene will not crack, dent, bubble, chip, rust or break.

Colors: Granite Gray (191), Granite Green (192), Navy Blue (186), Hot Red (158), Kentucky Green (519), Black Base with Granite Gray Top & Doors (426).

6" Casters: 2 fixed, 2 swivel, 2 with brake.

Top work area dimensions: 22½" x 26"



Shown with optional cutting board and paper towel roll dispenser.

CODE	DESCRIPTION	DIMENSIONS L x W x H	CASE LBS. (CUBE)	LIST PRICE EA.
KWS40	Work Station	40 ⁹ / ₁₆ " x 32 ¹ / ₂ " x 45 ¹ / ₂ "	148.47 (39.41)	\$ 2,480.00
CB1220	Cutting Board	21" x 13 ³ / ₈ " x 1 ¹ / ₂ "	4 (0.31)	42.00

Case Pack: 1

Equipment Stand

- Perfect for self-serve stations, prep areas or cash register service.
- Counter and side openings for electrical cords and cables.
- Durable, lightweight polyethylene will not crack, dent, bubble, chip, rust or break.
- No assembly required.

Colors: Black (110).

5" Casters: 2 fixed, 2 swivel with brake.

* Special order item not carried in stock – non-returnable.







Cutaway chair area gives ample space for comfortable seating.

CODE	DESCRIPTION	OVERALL DIMENSIONS W (W/TRAY RAILS) x D x H	CASE LBS. (CUBE)	LIST PRICE EA.
ES28	Stand only	28" x 28" x 39"	76 (19.15)	\$ 1,255.00
ES28RL*	Stand w/Rails on right and left sides of drawer	44" x 28" x 39"	85.33 (19.07)	1,675.00

Height includes casters.

Camcruiser® Vending Carts

- Add revenue opportunities away from the kitchen or cafeteria and reduce wait times.
- Durable polyethylene will not crack, dent, bubble, chip, rust or break.
- Display panel can be personalized with a custom logo or message.
- Larger models CVC724 & CVC72 have insulated food storage compartments and full-size food pan wells.
- Compact model CVC55 has two open storage compartments, a single food pan well, cutting board and umbrella.

Cart Color	Umbrella Color
Black (110)	
Hot Red (158)	
Kentucky Green (519)	
Granite Gray (191)	
Granite Green (192)	



CVC724
OPEN COMPARTMENT DIMENSIONS:
W 13 7/8" x D 24 1/4" x H 13 1/4"
W 33,5 x D 61,5 x H 34 cm

CVC724 & CVC72



CVC724 has four full size food pan wells. Fill with cutting boards or well covers to create additional work space.



CVC72



CVC72 One full size food pan well and two larger merchandising wells.



Open holding compartment conveniently stores cash box and tray.



Place one or two half size Camchillers® directly on top of food pan well to hold cold packaged foods cold.

CODE	CVC724	CVC72	CVC55
OVERALL DIMENSION*	L 74 1/2" x W 31 3/4" x H 94"	L 74 1/2" x W 31 3/4" x H 94"	L 55 3/16" x W 31 1/4" x H 93 1/2"
WORK COUNTER HEIGHT	36 1/2" (93 cm)	36 1/2" (93 cm)	39 3/4" (101 cm)
COUNTER WELLS HOLD	4 full size pans, 6" deep	Center well, 1 full size pan, 6" deep 2 outer wells, L 22 1/8" x W 15 3/8" x D 6"	1 full size pan, 6" deep
CLOSED COMPARTMENT CAPACITY (EACH)	2 full size 8" + 2 full size 2 1/2" deep pans or 4 full size 6" deep pans or 6 full size 4" deep pans or 8 full size 2 1/2" deep pans or 4 each 2025 Camtrays or 8 each 3253 Camtrays	2 full size 8" + 2 full size 2 1/2" deep pans or 4 full size 6" deep pans or 6 full size 4" deep pans or 8 full size 2 1/2" deep pans or 4 each 2025 Camtrays or 8 each 3253 Camtrays	—
OPEN COMPARTMENT CAPACITY	1 cash drawer and 1 full size 6" deep pan or 2 full size 4" deep pans or 3 full size 2 1/2" deep pans	1 cash drawer and 1 full size 6" deep pan or 2 full size 4" deep pans or 3 full size 2 1/2" deep pans	—
UMBRELLA DIAMETER	72" (183 cm)	72" (183 cm)	60" (152 cm)
CASTERS	8" – 4 swivel with brake	8" – 4 swivel with brake	6" – 2 fixed, 2 swivel with brake
CASH DRAWER	Yes	Yes	—
MENU BOARD	Yes	Yes	—
DISPLAY PANEL	Yes	Yes	Yes
MOLDED IN HANDLES	2	2	1
CASE LBS. (CUBE)	265.6 (74.42)	283 (76.59)	167.65 (45.65)
LIST PRICE EACH	\$ 5,830.00	\$ 5,830.00	\$ 3,495.00

* Includes Umbrella. Serving counter height is 51".

Camcruiser® Vending Carts



CVC55



LEFT COMPARTMENT DIMENSIONS:
W 24½" x D 28½" x H 27½"

RIGHT COMPARTMENT DIMENSIONS:
W 21½" x D 28½" x H 27½"

- Compartments are open for storage and easy access to equipment and supplies for your vending operations. Optional retainer strap is sold separately.
- Display panel can be personalized.

Personalize your Camcruiser Cart to promote your brand.

Front Display Panel

"Campus Cuisine" display panel standard on CVC724 & CVC72.

Striped panel standard on CVC55.

Set Up Charge per Panel \$ 135.00 (Net)

Charge per Color 10.00 (Net)



Sandwich Camcruiser



Pizza Camcruiser



Hot Dog Camcruiser



Soft Drink Camcruiser

Cutting Board Color: White (148).
Camchiller® Color: Cold Blue (159).
Divider Bar Colors: White (148), Clear (135).
Retainer Strap Color: Black (110).
ThermoBarrier® Color: Dark Brown (131).

ThermoBarrier, Camchillers and Divider Bar are NSF Listed.

Well Cover Color matches cart.

CVC55 is covered by U.S. Patent D 362,102.



CVC55



Set up with full or fractional size food pans and divider bars to increase product offerings.



Electrical or soda line conveniently drops through 4" x 6¼" opening in counter. Cover is standard with cart.

CODE	DESCRIPTION	FITS	OVERALL DIMENSIONS L x W x H	CASE LBS. (CUBE)	LIST PRICE EA.
Optional Accessories					
CB1220	Cutting Board	CVC724, CVC72, CVC55	21" x 13½" x ½"	4 (0.31)	\$ 42.00
1200DIV	ThermoBarrier	CVC724, CVC72	20⅞" x 13⅞" x 1⅜"	7.75 (0.67)	75.00
CP1220	Full GN Camchiller	CVC724, CVC72	20⅜" x 12⅞" x 1½"	8.15 (0.32)	130.00
CP1210	½ GN Camchiller	CVC724, CVC72	10⅜" x 12⅞" x 1½"	3.8 (0.18)	67.00
CP814	Camchiller	CVC55, CVC72, CVC724	14" x 8" x 1½"	3.8 (0.19)	67.00
DIV12	Divider Bar	CVC724, CVC72, CVC55	Well Only	0.05 (0.02)	4.00
WCR1220	Well Cover	CVC724, CVC72, CVC55	21" x 13" x 2"	5 (0.55)	99.00
730STP	Retainer Strap	CVC55	—	1 (0.05)	26.00

DIV12 Case Pack: 3 - 1200DIV **Retainer Strap Case Pack:** 2 **Case Pack:** 1 - All Others

Booster Seats & Versa Organizers

Booster Seats

- Contoured seat, high sides, wide square base and non-skid surface for toddler comfort and safety.
- Choose from dual or single seat models, with or without strap.
- Durable polyethylene will not crack, dent, bubble, chip, rust or break.

Colors: Black (110), Dark Brown (131), Coffee Beige (157), Navy Blue (186), Kentucky Green (519), Hot Red (158).

No broken cartons on 4 pack.



A Single Seat

B Dual Seat



Booster seats are available with or without straps.

Dimensions	W x D x H
Overall	11 ⁵ / ₈ " x 11 ¹ / ₄ " x 8 ⁵ / ₈ "
Seat Base	8 ³ / ₄ " x 9 ³ / ₄ "
Inside Seat	9 ¹ / ₂ " x 9 ³ / ₄ " x 4 ³ / ₈ "

Dimensions	W x D x H
Overall	12 ⁷ / ₁₆ " x 12 ¹ / ₄ " x 9 ³ / ₈ "
Seat Base A	12 ⁷ / ₁₆ " x 12 ¹ / ₄ "
Seat Base B	12 ⁵ / ₈ " x 12 ¹ / ₈ "
Inside Seat A	8 ¹ / ₄ " x 9 ⁵ / ₈ " x 3 ¹ / ₄ "
Inside Seat B	10 ³ / ₄ " x 10 ¹ / ₄ " x 4 ³ / ₄ "

CODE	100BC	100BC1	100BCS
Single Seat			
DESCRIPTION	no strap	no strap	with strap
CASE PACK	4	1	4
CASE LBS. (CUBE)	9.34 (2.12)	2.70 (0.67)	9.82 (2.12)
LIST PRICE EACH	\$ 40.00	\$ 45.00	\$ 60.00

CODE	200BC	200BC1	200BCS
Dual Seat			
DESCRIPTION	no strap	no strap	with strap
CASE PACK	4	1	4
CASE LBS. (CUBE)	15.93 (3.76)	4.31 (0.97)	16.41 (3.76)
LIST PRICE EACH	\$ 55.00	\$ 60.00	\$ 70.00

Versa Organizers

- Use to store non-perishable condiments, disposable ware and napkins.
- Hold bins in 2 x 3, 2 x 4, 3 x 3, or 3 x 4 arrangements.
- Made of seamless, one-piece polyethylene.
- Set on flat surface or wall mount each bin holds up to 10 lbs. (4,5 kg).
- Easy to assemble and easy to clean.

Bins Only

Colors: Coffee Beige (157), Dark Brown (131), Black (110), Slate Blue (401), Speckled Gray (480).

Versa Line Combined Pack Bins & Racks

Colors: Dark Brown (131), Black (110), Speckled Gray (480).



12RS12 Versa Organizer shown mounted on wall.



Bins sold separately (5412CBP) or as combined packs.



8RS8



6RS6

CODE	DESCRIPTION	PRODUCT DIMENSIONS	CASE PACK	CASE LBS. (CUBE)	LIST PRICE EA.
Bins		W x D x H			
5412CBP		5" x 12" x 4 ¹ / ₄ "	12	7.84 (1.78)	\$ 9.55
Versa Line Combined Pack		L x D x H (complete unit)			
12RS12	Rack w/12 bins	25 ¹ / ₂ " x 21 ¹ / ₈ " x 14 ¹ / ₄ "	1	14.77 (3.29)	196.00
9RS9	Rack w/9 bins	20 ¹ / ₂ " x 21 ¹ / ₈ " x 14 ¹ / ₄ "	1	11.76 (2.65)	173.00
8RS8	Rack w/8 bins	25 ¹ / ₂ " x 17 ¹ / ₄ " x 9 ¹ / ₄ "	1	9.81 (2.33)	158.00
6RS6	Rack w/6 bins	20 ¹ / ₂ " x 17 ¹ / ₄ " x 9 ¹ / ₄ "	1	7.84 (1.64)	142.00



BAR540 Shown in Standard Decor Slate Blue (401).
1.800.833.3003

Portable CamBars®

- Stylish, portable beverage bars for hosting in any environment.
- Select from three systems: economy for bottle and can service, partial or complete soda gun set up systems for pre-mix (canisters) or post-mix (bag-in-box).
- Available in three sizes:
 - Large BAR730 is perfect for banquets and cocktail events.
 - Mid-size BAR650 fits into standard elevators and is ideal for small to mid-size functions.
 - Small BAR540 is ultra portable for off-premise use and events with limited space.
- All models include speed rail and 80-pound capacity ice sink with cover. BAR540 sink comes uncovered.
- Impact-resistant, waterproof polyethylene will not crack, dent, bubble, chip, rust or break.
- Lightweight and portable.
- Easy to take apart and clean, easy to set up.



BAR650 Shown in Standard Decor Granite Sand (194).





BAR650DS Shown in Designer Decor Sedona (668).

 Personalization of the front panel is available on Designer Decor Chicago model only for..... \$ 175.00

Three Sizes

Three Systems

	Economy System	Basic System	Complete System
<p>Large BAR730 Models</p> 	<ul style="list-style-type: none"> • For Bottle, Can, or Mixer Service • Includes Ice Bin & Speed Rail • Standard or Designer Decor 	<ul style="list-style-type: none"> • Partially Equipped for Post or Pre-Mix Soda Service • Operator Completes Installation • Standard or Designer Decor 	<ul style="list-style-type: none"> • Completely Factory Equipped for Post or Pre-Mix Soda Service • Standard or Designer Decor
<p>Standard Decor BAR730</p> <p>Designer Decor BAR730DS</p>	<p>Standard Decor BAR730CP</p> <p>Designer Decor BAR730DSCP</p>	<p>Standard Decor BAR730PM, BAR730PMT, BAR730PMT220, BAR730DX</p> <p>Designer Decor BAR730DSPM, BAR730DSPMT, BAR730DSPMT2, BAR730SDX</p>	
<p>Mid-Size BAR650 Models</p>	<p>Standard Decor BAR650</p> <p>Designer Decor BAR650DS</p>	<p>Standard Decor BAR650CP</p> <p>Designer Decor BAR650DSCP</p>	<p>Standard Decor BAR650PM, BAR650PMT, BAR650PMT220, BAR650DX</p> <p>Designer Decor BAR650DSPM, BAR650DSPMT, BAR650DSPMT2, BAR650SDX</p>
<p>Small BAR540 Models</p> 	<p>Standard Decor BAR540</p> <p>Designer Decor BAR540DS</p>	N/A	N/A

Portable CamBar® Packages & Accessories

Standard Equipment, Soda Guns, Standard and Designer Decor Packages

STANDARD DECOR EQUIPMENT DESIGNER DECOR EQUIPMENT	ECONOMY			BASIC SYSTEM		COMPLETE SYSTEM POST-MIX (Bag in Box)				COMPLETE SYSTEM PRE-MIX (Canisters)	
	BAR540 BAR540DS	BAR650 BAR650DS	BAR730 BAR730DS	BAR650CP BAR650DSCP	BAR730CP BAR730DSCP	BAR650PM BAR650DSPM	BAR650PMT BAR650DSPMT	BAR730PM BAR730DSPM	BAR730PMT BAR730DSPMT	BAR650DX BAR650SDX	BAR730DX BAR730SDX
Bag In Box Syrup Pumps						3	3	6	6		
Bag In Box Rack (Holds 3 Boxes)						1	1	2	2		
Carbonator						YES	YES	YES	YES		
CO ₂ Regulator						YES	YES	YES	YES	YES	YES
CO ₂ Clamp & Chain				YES	YES	YES	YES	YES	YES	YES	YES
Ice Sink – 8 Circuit Cold Plate				YES	YES	YES	YES	YES	YES	YES	YES
Ice Sink and Cover	Sink Only	YES	YES	YES	YES	YES	YES	YES	YES	YES	YES
Retainer Strap		1	2	1	2	1	1	2	2	1	2
Soda Gun (5, 6 or 8 buttons)						5	5	8	8	5	6
Speed Rail (5 or 7 bottle)	5	7	7	7	7	7	7	7	7	7	7
Water Pump							YES		YES		
Water Tank							YES		YES		
Water Line Hook Up (city source)						YES		YES			
Waste Water Bin		YES	YES	YES	YES	YES	YES	YES	YES	YES	YES
Vinyl Cover	YES	YES	YES	YES	YES	YES	YES	YES	YES	YES	YES

Casters: All BAR540 Models - Four 5" swivel, two with brake. All BAR650 and BAR730 Models - Four 6" swivel, two with brake.

Soda Guns by Wunder-Bar®

- Fast, low foaming delivery
- Two year warranty from Wunder-Bar®
- Includes holster with overflow drain
- Available with complete systems only



Post-Mix 8 Button
(BAR730 Complete System)



Post-Mix 5 Button
(BAR650 Complete System)



Pre-Mix 6 Button
(BAR730 Complete System)



Pre-Mix 5 Button
(BAR650 Complete System)

Standard Decor Colors BAR540, BAR650, BAR730



BAR650, BAR730 Only



BAR540 Only



Designer Decor BAR650, BAR730 Only

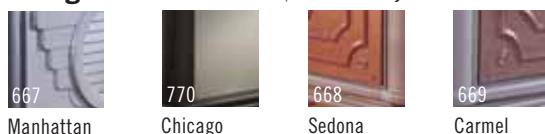

BAR540 Designer Décor color options are listed with BAR540 details.

Exclusive Cold Plate

- Patented "roof top" design allows for melted ice water to drain into the bottom of the ice sink and into the waste-water bin.
- Circuit exposure through cold plate chills liquids dispensed from the soda gun.



Optional Accessories for CamBars

CODE	DESCRIPTION	CASE LBS. (CUBE)	LIST PRICE EA.
650WS	Wire Shelf for BAR650	5.50 (1.23)	\$ 66.00
730WS	Wire Shelf for BAR730	5.1 (1.49)	46.00
730SR	7 Bottle Speed Rail	5.25 (1.33)	105.00
BAR54SR	5 Bottle Speed Rail	5.50 (1.33)	72.00

Case Pack: 1 Speed Rail Colors: See Standard Decor colors.

Large CamBars® – Complete Systems BAR730

Post-mix System for 5-gallon, Bag-in-box Syrup

Holds up to 6 syrup boxes and 1 CO₂ tank

Standard Decor

Dimensions: L 72¾" x W 26" x H 48"

CODE	BAR730PM	BAR730PMT	BAR730PMT220
VOLTS	110	110	220
WATER TANK	NO	YES	YES
UNIT WEIGHT	324 lbs.	344 lbs.	344 lbs.
CASE LBS. (CUBE)	360 (58.75)	380 (58.75)	380 (58.75)
LIST PRICE EACH	\$ 14,150.00	\$ 15,485.00	\$ 15,600.00

Designer Decor

Dimensions: L 77¾" x W 28½" x H 47½"

CODE	BAR730DSPM	BAR730DSPMT	BAR730DSPMT2
VOLTS	110	110	220
WATER TANK	NO	YES	YES
UNIT WEIGHT	362 lbs.	382 lbs.	382 lbs.
CASE LBS. (CUBE)	398 (67.02)	418 (67.02)	418 (67.02)
LIST PRICE EACH	\$ 15,995.00	\$ 18,035.00	\$ 18,150.00

BAR730PM and BAR730DSPM

Includes the standard equipment from the Basic System plus

- Post-mix soda gun with 8 buttons
- Carbonator
- 2 stainless steel bag-in-box wire racks
- 6 bag-in-box pumps
- CO₂ regulator gauge & tubing, hose & lines
- Line for city water hook-up

BAR730PMT, BAR730DSPMT, BAR730PMT2 & BAR730DSPMT2

Includes all the above plus 1, 17-gallon (64,3 L) water tank and 1 water pump.

Line for city water hook-up not included.



BAR730SDSX Shown in Designer Decor Carmel (669)



BAR730DSPMT (Shown with water tank and bag-in-box racks.)



Vinyl cover included with all CamBars. Cover not NSF listed.

Pre-mix System for 5-gallon (18,9 L) Soda Canisters

Holds up to 7 canisters and 1 CO₂ tank

	Standard Decor	Designer Decor
CODE	BAR730DX	BAR730DSDX
DIMENSION	L 72¾" x W 26" x H 48"	L 77¾" x W 28½" x H 47½"
WATER TANK	NO	YES
UNIT WEIGHT	264 lbs.	274 lbs.
CASE LBS. (CUBE)	356 (63.56)	338 (67.02)
LIST PRICE EACH	\$ 9,370.00	\$ 12,595.00

BAR730DX and BAR730DSDX

Includes

- Pre-mix soda gun with 6 buttons
- Sealed-in cold plate w/8 circuits
- CO₂ chain
- 7-bottle speed rail
- 80-pound (36,3 kg) capacity ice sink
- Ice sink cover
- Waste-water bin
- 2 retainer straps
- 4, 6" (15,2 cm) swivel casters, 2 with brake
- Vinyl cover

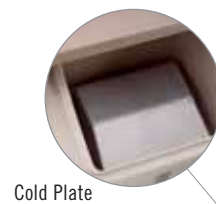

Cold Plate



BAR730DX

Large CamBars® – Economy and Basic Systems BAR730

Economy System BAR730

For Bottle, Can or Mixer Service

	Standard Decor	Designer Decor
CODE	BAR730	BAR730DS
DIMENSION	L 72¼" x W 26" x H 48"	L 77½" x W 28½" x H 47½"
UNIT WEIGHT	205 lbs.	232 lbs.
CASE LBS. (CUBE)	229 (58.75)	295 (67.02)
LIST PRICE EACH	\$ 5,590.00	\$ 7,585.00

Includes

- 7-bottle speed rail
- 80-pound (36,3 kg) capacity ice sink
- Ice sink cover
- Waste-water bin
- 2 retainer straps
- 4, 6" (15,2 cm) swivel casters, 2 with brake
- Vinyl cover



BAR730DS
Shown in Designer
Decor Chicago (770).



Basic System BAR730

Partially Equipped for Soda Service

Requires customer installation of pre-mix or post-mix soda gun system

	Standard Decor	Designer Decor
CODE	BAR730CP	BAR730DSCP
DIMENSION	L 72¼" x W 26" x H 48"	L 77½" x W 28½" x H 47½"
UNIT WEIGHT	254 lbs.	292 lbs.
CASE LBS. (CUBE)	290 (58.75)	409 (68.46)
LIST PRICE EACH	\$ 8,065.00	\$ 11,465.00

Includes

- Sealed-in cold plate w/8 circuits
- CO₂ chain
- 7-bottle speed rail
- 80-pound (36,3 kg) capacity ice sink
- Ice sink cover
- Waste-water bin
- 2 retainer straps
- 4, 6" (15,2 cm) swivel casters, 2 with brake
- Vinyl cover



Cold Plate



BAR730DSCP
(Shown with four optional wire racks; see details under Portable CamBar Packages & Accessories.)

Mid-Size CamBars® – Complete Systems BAR650

Post-mix System for 5-gallon (18,9 L)
Bag-in-box Syrup

Holds up to 3 syrup boxes and 1 CO₂ tank

Standard Decor

Dimensions: L 67½" x W 28½" x H 47½"

CODE	BAR650PM	BAR650PMT	BAR650PMT220
VOLTS	110	110	220
WATER TANK	NO	YES	YES
UNIT WEIGHT	335 lbs.	335 lbs.	335 lbs.
CASE LBS. (CUBE)	360 (52.91)	342 (52.91)	380 (29.39)
LIST PRICE EACH	\$ 13,175.00	\$ 14,455.00	\$ 14,890.00

Designer Decor

Dimensions: L 67½" x W 28½" x H 47½"

CODE	BAR650DSPM	BAR650DSPMT	BAR650DSPMT2
VOLTS	110	110	220
WATER TANK	NO	YES	YES
UNIT WEIGHT	342 lbs.	362 lbs.	362 lbs.
CASE LBS. (CUBE)	367 (52.91)	387 (52.91)	450.50 (59.59)
LIST PRICE EACH	\$ 14,550.00	\$ 16,420.00	\$ 16,530.00

BAR650PM and BAR650DSPM

Includes the standard equipment from Basic System plus

- Post-mix soda gun with 5 buttons
- Carbonator
- Stainless steel bag-in-box wire rack
- 3 bag-in-box pumps
- CO₂ regulator gauge & tubing, hose & lines
- Line for city water hook-up

BAR650PMT, BAR650DSPMT, BAR650PMT2 & BAR650DSPMT2

Includes all the above plus 1, 17-gallon (64,3 L) water tank and 1 water pump. Line for city water hook-up not included.



BAR650DSPMT
(Shown with water tank and bag-in-box rack.)

Pre-mix System for 5-gallon (18,9 L) Soda Canisters

Holds up to 5 canisters and 1 CO₂ tank

	Standard Decor	Designer Decor
CODE	BAR650DX	BAR650SDSX
DIMENSION	L 67½" x W 28½" x H 47½"	L 67½" x W 28½" x H 47½"
UNIT WEIGHT	285 lbs.	292 lbs.
CASE LBS. (CUBE)	340.2 (52.91)	317 (52.91)
LIST PRICE EACH	\$ 8,780.00	\$ 10,640.00

BAR650DX and BAR650SDSX

Includes

- Pre-mix soda gun with 5 buttons
- Sealed-in cold plate w/8 circuits
- CO₂ chain
- 7-bottle speed rail
- 80-pound (36,3 kg) capacity ice sink
- Ice sink cover
- Waste-water bin
- Retainer strap
- 4, 6" (15,2 cm) swivel casters, 2 with brake
- Vinyl cover



Cold Plate

BAR650SDSX

Mid Size and Small CamBars® – Economy and Basic Systems

Basic System BAR650 – Mid-Size Model

Partially Equipped for Soda Service

Requires customer installation of pre-mix or post-mix soda gun system

	Standard Decor	Designer Decor
CODE	BAR650CP	BAR650DSCP
DIMENSION	L 67½" x W 28½" x H 47½"	L 67½" x W 28½" x H 47½"
UNIT WEIGHT	264 lbs.	271 lbs.
CASE LBS. (CUBE)	317.8 (52.91)	307 (52.91)
LIST PRICE EACH	\$ 7,110.00	\$ 9,225.00

Includes

- Sealed-in cold plate with 8 circuits
- CO₂ chain
- 7-bottle speed rail
- 80-pound (36,3 kg) capacity ice sink
- Ice sink cover
- Waste-water bin
- Retainer strap
- 4, 6" (15,2 cm) swivel casters, 2 with brake
- Vinyl cover



BAR650DSCP
(Shown with two optional wire racks; see details under Portable CamBar Packages & Accessories.)

Economy System BAR650 – Mid-Size Model

For Bottle, Can or Mixer Service

	Standard Decor	Designer Decor
CODE	BAR650	BAR650DS
DIMENSION	L 67½" x W 28½" x H 47½"	L 67½" x W 28½" x H 47½"
UNIT WEIGHT	185 lbs.	192 lbs.
CASE LBS. (CUBE)	215.8 (52.91)	217 (52.91)
LIST PRICE EACH	\$ 4,775.00	\$ 6,500.00

Includes

- 7-bottle speed rail
- 80-pound (36,3 kg) capacity ice sink
- Ice sink cover
- Waste-water bin
- Retainer strap
- 4, 6" (15,2 cm) swivel casters, 2 with brake
- Vinyl cover



BAR650DS
(Shown with two optional wire racks; see details under Portable CamBar Packages & Accessories.)

Economy System BAR540 – Small Model

For Bottle, Can, or Mixer Service

Dimensions: L 54" x W 25⅞" x H 46⅞"

	Standard Decor	Designer Decor
CODE	BAR540	BAR540DS
UNIT WEIGHT	115 lbs.	120 lbs.
CASE LBS. (CUBE)	140 (39.57)	145 (39.57)
LIST PRICE EACH	\$ 2,445.00	\$ 3,130.00

Includes

- 5-bottle speed rail
- 80-pound (36,3 kg) capacity ice sink
- 4, 5" (12,7 cm) swivel casters, 2 with brake
- Vinyl cover

1.800.833.3003



BAR540DS

Designer Decor Colors

BAR540 Only

670 Black Base w/ Coal Counter

671 Granite Gray Base w/ Slate Gray Counter

672 Granite Sand Base w/ Cocoa Counter

SlidingLid™ Ice Caddies

- Polyethylene body and thick foam insulation hold ice for days.
- Rugged, all-weather exterior will not crack, dent, bubble, chip, rust or break.
- Unique sliding lid slides back and under during use, reducing risk of cross-contamination.
- Recessed well and drain shelf keep ice out of water, extending holding times.
- Recessed, molded-in handles ease lifting and maneuvering.
- No assembly required.

ICS125L
(Short)



ICS100L4S
(Short)



ICS100L
(Short)



These units feature a slant top sliding lid, hold up to 100 lbs. of ice and fit under prep/catering tables, counters or the CamKiosk Bridge.

ICS175LB
(Short) Shown with Rear Easy Wheels.



Colors: Black (110), Slate Blue (401), Dark Brown (131), Coffee Beige (157), Gray (180), Granite Gray (191), Granite Green (192).

Personalization available. Special quote only. Contact customer service.

SlidingLid Ice Caddies ICS125L and ICS125LB are covered by US Patent D 468,071 S. SlidingLid Ice Caddies ICS100L and ICS100L4S are covered by US Patent D 424,883.



ICS175T
(Tall)



BAR650DS Shown in Designer Decor Sedona (668) with ICS175TB.

Caster Descriptions

Refers to caster type in chart. All casters are 5".

A:	2 fixed, 2 swivel, 1 with brake
A1:	2 swivel, 2 with brakes
B:	4 swivel, 1 with brake
C:	2 swivel, 1 with brake, 2, 8" Easy Wheels
D:	2 swivel, 1 with brake, 2, 10" Easy Wheels
E:	2 swivel, 1 with brake, 2, 10" Wide Easy Wheels

ICS175TB
(Tall) Shown with Rear Easy Wheels.



ICS200TB
(Tall) Shown with Rear Wide Easy Wheels.



CODE	HOLDING CAPACITY LBS.	EXTERIOR DIMENSIONS W x D x H	CASTER TYPE	CASE LBS. (CUBE)	LIST PRICE EA.
Short					
ICS100L	100	22½" x 30¼" x 28¾"	A1	53 (11.54)	\$ 965.00
ICS100L4S	100	22½" x 30¼" x 28¾"	B	59 (11.88)	990.00
ICS125L	125	23" x 31½" x 29¼"	A	60.33 (13.33)	985.00
ICS125LB	125	23" x 31½" x 29¼"	C	71 (13.16)	1,060.00
ICS175L	175	24" x 37½" x 29¼"	A	78 (16.3)	1,175.00
ICS175LB	175	24" x 37½" x 29¼"	D	80 (16.3)	1,220.00
Tall					
ICS125T	125	23" x 31½" x 34½"	A	70.6 (15.46)	1,050.00
ICS175T	175	23" x 34" x 37½"	A	80.6 (18.06)	1,230.00
ICS175TB	175	23" x 34" x 37½"	D	83.67 (18.25)	1,315.00
ICS200TB	200	23" x 34" x 39½"	E	98 (19)	1,345.00

Case Pack: 1 InStock Colors: Black (110), Dark Brown (131).





INSULATED TRANSPORT



Insulated Beverage Servers

- Use to hold, transport and serve hot or cold beverages for up to 4 hours.
- Pre-heat or pre-chill before use to guarantee maximum operational efficiency.
- Sturdy latches secure lids tightly and will never rust.
- Drip-proof recessed spigot for easy self-serve access.
- Molded-in metal backing plates Prevents latches from breaking away from the container.

Insulated Beverage Servers



Insulated Beverage Servers

- Stack units on riser to fill large cups or coffee pots.
- Stack interlocking ensures stable stacking during transport and storage.

UC250 and UC500 covered by U.S. Patent D 403,917. UC1000 covered by U.S. Patent D 403,916.



Stacking options:

- 100LCD with 100LCD
- All 250, 350 and 500 units
- UC1000 and 1000LCD

Hot — temperature loss averaging 3°F/hour.

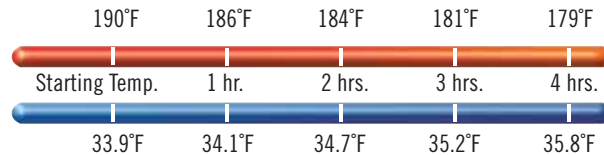

Cold — temperature gain averaging 1.5°F/hour.



Durable and attractive covers dress up and extend the life of your Camtainers.

Personalization available. Contact your Cambro representative for details.



Vent Cap

Equalizes pressure. Makes opening the container much easier.



Recessed Faucet

Accommodates larger cups. Allows even dispensing and eliminates drips. Two positions: one for continuous pouring and one for individual dispensing.



Molded-in Metal Backing Plates

Prevents latches from breaking away from the container.



Ultra Camtainers®

Feature wide nylon latches which are easy to open and close with one hand.



Camtainers®

Feature sturdy plastic latches that secure lids tightly and will never rust.

Insulated Beverage Servers

Camtainers®

The standard for many caterers. Four sturdy plastic latches on each unit open and close easily and will never rust.



CODE	100LCD	250LCD	500LCD	1000LCD	350LCD (SOUP)
CAPACITY	1½ gal.	2½ gal.	4½ gal.	11¾ gal.	3¾ gal.
7 OZ. CUPS	27	45	86	214	61
SPIGOT	YES	YES	YES	YES	—
EXTERIOR DIM. W x D x H	10¾" x 11½" x 17¼"	9" x 16½" x 18¾"	9" x 16½" x 24¼"	16¼" x 20¾" x 24¾"	9" x 16½" x 18¾"
FITS CAMDOLLY®	—	CD100, CD100H, CD100HB	CD100, CD100H, CD100HB	CD300, CD300H, CD300HB	CD100, CD100H, CD100HB
CASE LBS. (CUBE)	9.50 (1.24)	12.75 (1.73)	15.50 (2.26)	28 (5.27)	13.4 (1.65)
LIST PRICE EACH	\$ 220.00	\$ 230.00	\$ 265.00	\$ 405.00	\$ 225.00
CAMTAINER COVER	—	250LDCVCR / \$ 130.00	500LDCVCR / \$ 130.00	1000LDCVCR / \$ 130.00	—

Case Pack: 1 Colors: Navy Blue (186), Slate Blue (401), Coffee Beige (157), Dark Brown (131), Brick Red (402), Kentucky Green (519), Black (110), Hot Red (158).

InStock Colors: Dark Brown (131), Black (110). Cover InStock Color: Black (110). Venting plug is covered by US Patent D 553,717 S.

Refer to page 153 for Camdollies listing.

Ultra Camtainers®

A contemporary line, featuring two wide nylon latches per unit that are easy to open and close.



CODE	UC250	UC500	UC1000
CAPACITY	2¾ gal.	5½ gal.	10½ gal.
7 OZ. CUPS	50	96	192
EXTERIOR DIM. W x D x H	11¾" x 16¾" x 19¾"	11¾" x 16¾" x 26¾"	16¼" x 20½" x 25¾"
FITS CAMDOLLY	CD100, CD100H, CD100HB	CD100, CD100H, CD100HB	CD300, CD300H, CD300HB
CASE LBS. (CUBE)	15.10 (2.41)	18.86 (3.22)	29.19 (5.24)
LIST PRICE EACH	\$ 270.00	\$ 305.00	\$ 410.00
CAMTAINER COVER	UC250CVR / \$ 130.00	UC500CVR / \$ 130.00	UC1000CVR / \$130.00

Case Pack: 1 Colors: Navy Blue (186), Slate Blue (401), Coffee Beige (157), Dark Brown (131), Brick Red (402), Kentucky Green (519), Black (110), Granite Gray (191), Granite Green (192), Granite Sand (194).

InStock Colors: Dark Brown (131), Black (110), Granite Gray (191). Venting plug is covered by US Patent D 553,717 S.

Cover InStock Color: Black (110). Refer to page 153 for Camdollies listing.

Camserver®

- A front-of-house beverage server for hot or cold beverages that does not require canned heating.
- Double-wall polyethylene shell with thick foam insulation retains temperatures for hours.

Colors: Black (110), Dark Taupe (417), Granite Gray (191).



CSR3
Shown in
Dark Taupe.



CSR5
Shown in Black.

Height is approximately 7" from counter to spigot.



Convenient top-fill opening for fast replenishment without removing lid.

CODE	OVERALL DIMENSIONS W x D x H	CAPACITY	7 OZ. CUPS	CASE LBS. (CUBE)	LIST PRICE EA.
CSR3	13¼" x 18¼" x 23½"	3 gal.	54	18.35 (3.58)	\$ 465.00
CSR5	13¼" x 18¼" x 28"	5 gal.	91	21.79 (4.02)	485.00

Case Pack: 1

Insulated Beverage Servers Accessories

Handwash Accessories

- Convenient and economical way to meet health department hand washing requirements on or off premise.
- Attaches to 2.5 gallon (9.5 L) or 5-gallon (19 L) Camtainers® or Ultra Camtainers®.
- Includes four "Handwash Only" labels and an Easy Serve Dispenser lever.

Handwash Accessory Stocking Colors: Dark Brown (131), Black (110).

Easy Serve Dispenser Color: Black (110).

Riser Colors: See optional accessories with Camtainers.

Pail with Bail Color: White (148).

Handwash Accessory is covered by the following U.S. Patents: D 506,634 S, D 506,899 S & D 548, 980 S.



CODE	HWAPR	HWATD
DESCRIPTION	With Paper Towel Roll Holder	With Multi-Fold Paper Towel Dispenser
FITS	250LCD, 500LCD, UC250, UC500	250LCD, 500LCD, UC250, UC500
CASE LBS. (CUBE)	9.75 (2.06)	10.3 (2.03)
LIST PRICE EACH	\$ 250.00	\$ 330.00



Shown with 500LCD Camtainer®

Optional Handwash Accessories

CODE	DESCRIPTION	CASE LBS. (CUBE)	LIST PRICE EA.
R500LCD	Riser	2.6 (0.49)	\$ 90.00
PWB22	Pail with Bail	14 (3.2)	26.50
LCDES	Easy Serve Dispenser	0.25 (0.01)	17.05

R500LCD, PWB22, LCDES are NSF listed.

Optional Accessories



CODE	R500LCD	R1000LCD	LCDCH	LCDCH10	LCDES
DESCRIPTION	Riser	Riser	Condiment Holder	Condiment Holder	Easy Serve Dispenser
EXTERIOR DIM. W x D x H	9 ³ / ₈ " x 16 ¹ / ₄ " x 4 ³ / ₁₆ "	15 ³ / ₈ " x 19 ¹ / ₂ " x 4 ¹ / ₂ "	8 ³ / ₄ " x 16 ¹ / ₂ " x 5"	16" x 20" x 4 ¹³ / ₁₆ "	—
FITS	250LCD, 500LCD, UC250, UC500	1000LCD, UC1000	250LCD, 500LCD, UC250, UC500	1000LCD, UC250, UC500	LCD Spigots, UC Spigots
CASE LBS. (CUBE)	2.6 (0.49)	5.45 (0.93)	2.55 (0.5)	5.75 (1.07)	0.25(0.01)
LIST PRICE EACH	\$ 90.00	\$ 100.00	\$ 85.00	\$ 125.00	\$ 17.05

Case Pack: 1 **Colors:** Slate Blue (401), Coffee Beige (157), Dark Brown (131), Black (110), Granite Gray (191). **Easy Serve Dispenser Color:** Black (110).

Hydration Station

Cart with two 5-gallon beverage servers with covers can be used at full height with three shelves or at lower height with two shelves.



CODE	HYDRATIONPKG**
DESCRIPTION	1- KD Service Cart, 2- 500LCD Beverage Servers, 2- Easy Serve Dispensers and 2- Black Personalized Beverage Server Covers stating "Water"
DIMENSIONS* W x D x H	40" x 21 ¹ / ₄ " x 56 ³ / ₄ "
CASE LBS. (CUBE)	71.67 (14.63)
LIST PRICE EACH	\$ 1,116.00

Case Pack: 1 **Camtainer® and Cover Color:** Black (110)

*Dimensions based on 3 shelf cart with Camtainers on top shelf.

**Ships in 7 separate cartons.

Beverage Service Carts



- Ideal for breakfast, coffee or snack service.
- Use top counter to hold Cambro Beverage Servers, Versa Organizer Bins or Display Trays with Covers for food.
- Store drinkware, additional food items or other supplies in open compartment.
- Insulated cabinets hold hot or cold food in full, ½ or ⅓ size food pans or on Cambro Metric Camtrays® (3253).

Colors: Slate Blue (401), Granite Gray (191), Granite Green (192).

See Organizer section for more information on Organizer Bins.

See Beverage Server section for more information.

Wire Rack Color: Silver (000).

6" Casters: 2 fixed, 2 swivel, 1 with brake.



Beverage Service Cart is designed to hold Beverage Containers at point of service only. A dolly or hand truck with safety strap is recommended for moving Beverage Containers over longer distances or uneven surfaces.



MDC24F
Shown in Granite Gray (191).

CODE	EXTERIOR DIMENSIONS L x W x H	CASE PACK	CASE LBS. (CUBE)	LIST PRICE EA.
MDC24F	44½" x 30" x 44"	1	133 (37.82)	\$ 2,390.00
MDC24	44½" x 30" x 44"	1	133 (37.82)	2,390.00
OPTIONAL ACCESSORIES				
Organizer Bin				
5412CBP	12" x 5" x 4¼"	12	7.84 (1.78)	9.55
Camtainer®				
100LCD	10⅜" x 11¾" x 17¼"	1	9.50 (1.24)	220.00
Wire Rack				
MDC24R	23" x 17" x 14"	1	15 (3.36)	140.00
Camchiller®				
CP1220	20⅓" x 12⅞" x 1½"	1	11 (0.38)	130.00



MDC24, shown in Granite Green (192), has recessed top that holds 3 each 1 gallon Camtainers and stacked Condiment Bins & Wire Rack with 3253 trays.

The use of racks in the MDC24 and MDC24F carts will allow the following configuration of pans or trays, per compartment:

DESCRIPTION	FULL (⅓)	HALF (½)	THIRD (⅓)
2½" Pans	(4) 12CW	(8) 22CW	(12) 32CW
4" Pans	(3) 14CW	(6) 24CW	(9) 34CW
6" Pans	(2) 16CW	(4) 26CW	(6) 36CW
8" Pans	(1) 18CW*	(2) 28CW*	(3) 38CW*
Metric Camtrays®	(10) 3253	—	—

* with room for 2½" or 4" pan above 8" pan.

Compartment dimensions:

Shelf Compartment:	W 37⅓"	D 25⅞"	H 10"
Holding Compartments:	W 17⅓"	D 23⅞"	H 14⅞"

Venting plug is covered by U.S. Patent D 553,717S.



MDC24R Wire Rack

Wire Rack (sold separately) to organize pans and trays in the cart. Rack holds Full, ½ and ⅓ size Food Pans and 3253 trays. When placed in cart's holding compartment, the rack allows room on either sides for CP1220 Camchillers®.

Insulated Food Servers (Non-Electric)



Single GN Food Pan, Top-Loading Carriers

- Top-loading food pan carriers hold, transport and serve a single full-size pan of hot or cold food.
- Sturdy and durable, seamless polyethylene or polypropylene with thick foam insulation.
- Molded-in handles on all four sides for easy carrying and handling.
- 100 Series interstacks within the series and 240MPC stacks only with 240MPCs.
- Use with divider bars to hold multiple fractional pans.
- Pans are easy to remove using finger notches.
- Carriers interlock and stack for transporting and storing.

UPCS Colors: Dark Brown (131), Speckled Gray (480), Coffee Beige (157), Black (110).

MPC and MPCHL Colors: Navy Blue (186), Slate Blue (401), Coffee Beige (157), Dark Brown (131), Brick Red (402), Kentucky Green (519), Black (110), Hot Red (158).

UPC Colors: Slate Blue (401), Coffee Beige (157), Dark Brown (131), Black (110), Granite Gray (191), Granite Green (192), Granite Sand (194).

See Food Pan Section and Camdolly Section for pricing and ordering information.

Note: Place food pans on rails. Pans should not be placed on the floor of a Camcart or Camcarrier® cavity.

Note: If using metal food pans, cool to 250°F before placing into carriers.



UPC160
Shown with dividers and fractional sized food pans.

UPC100
No divider bars available for UPC100.

UPCS160



Stacking and storage reduced by 35%!

UPCSS160

Hot — temperature loss averaging 3°F/hour.

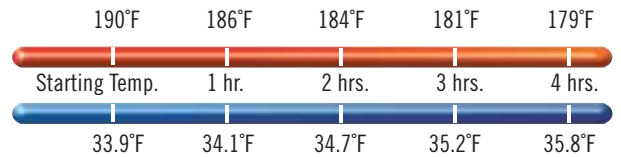

Cold — temperature gain averaging 1.5°F/hour.

Camcarrier®

One-piece, seamless polyethylene construction, airtight removable gasket and sturdy plastic latches.

CODE	240MPC	100MPCHL
COMPARTMENT CAPACITY	1 half size 2½" deep pan or 1 half size 4" deep pan	1 full size 8" deep pan
EXTERIOR DIM. W x D x H	16½" x 13⅞" x 7½"	26¾" x 18" x 15½"
INTERIOR DIM. W x D x H	13⅞" x 11⅛" x 4"	21¼" x 13¾" x 8"
BULK CAPACITY*	6.3 qts.	40 qts.
FITS CAMDOLLY®	CD1420	CD100, CD100H, CD100HB
CASE LBS. (CUBE)	8.7 (1.2)	30 (4.51)
LIST PRICE EACH	\$ 280.00	\$ 500.00

Case Pack: 1 * Without using food pans. Refer to page 153 for Camdollies listing.

Insulated Food Servers (Non-Electric)



S-Series

Durable polypropylene construction, built in seal and wide, nylon latches. Contemporary appearance and superior holding performance at an economical price.



CODE	UPCS140	UPCS160	UPCS180	UPCSS160*
COMPARTMENT CAPACITY	1 full size 4" deep pan	1 full size 6" deep pan	1 full size 8" deep pan	1 full size 6" deep pan
EXTERIOR DIM. W x D x H	25½" x 17½" x 8½"	25½" x 17½" x 10¼"	25½" x 17½" x 12"	24½" x 16½" x 9½"
CASE LBS. (CUBE)	17.5 (2.37)	19 (2.58)	20 (3.33)	17 (2.47)
FITS CAMDOLLY®	CD160	CD160	CD160	CD160
LIST PRICE EACH	\$ 260.00	\$ 270.00	\$ 290.00	\$ 270.00

Case Pack: 1 *UPCSS160 available in Dark Brown (131) and Coffee Beige (157) only. Temperature Maintenance Tool: CP1220 and CP1210 Camchiller®
Refer to page 153 for Camdollies listing.

Ultra Pan

One-piece, seamless polyethylene construction, airtight removable gasket and wide, nylon latches.



CODE	UPC140	UPC160	UPC180
COMPARTMENT CAPACITY	1 full size 4" deep pan	1 full size 6" deep pan	1 full size 8" deep pan
EXTERIOR DIM. W x D x H	24¾" x 17¾" x 8¼"	24¾" x 17¾" x 10¼"	24¾" x 17¾" x 12"
FITS CAMDOLLY	CD160	CD160	CD160
CASE LBS. (CUBE)	16.6 (2.15)	20.75 (2.72)	21.5 (3.18)
LIST PRICE EACH	\$ 375.00	\$ 380.00	\$ 390.00

Case Pack: 1 Refer to page 153 for Camdollies listing.

Multiple Stackable GN Food Pans, Top-Loading Carriers

100 Series

Store and stack food pans or place packaged food directly in compartment.



CODE	100MPC	UPC100	UPC101
COMPARTMENT CAPACITY	3 full size 2½" deep pans or 2 full size 4" deep pans or 1 full size 6" or 8" deep pan	3 full size 2½" deep pans or 2 full size 4" deep pans or 1 full size 6" or 8" deep pan	3 full size 2½" deep pans or 2 full size 4" deep pans or 1 full size 6" or 8" deep pan
EXTERIOR DIM. W x D x H	26¾" x 18" x 15"	26¾" x 18" x 15¼"	26¾" x 18" x 12½"
INTERIOR DIM. W x D x H	21¾" x 13¾" x 8"	22¾" x 13" x 8"	21¾" x 13¾" x 8¼"
BULK CAPACITY*	40 qts.	40 qts.	40 qts.
FITS CAMDOLLY	CD100, CD100H, CD100HB	CD100, CD100HB	CD100, CD100HB
CASE LBS. (CUBE)	27 (4.51)	25.25 (4.63)	24.5 (3.75)
LIST PRICE EACH	\$ 400.00	\$ 425.00	\$ 425.00

Case Pack: 1 *Without using food pans. Refer to page 153 for Camdollies listing.

Accessories

CODE	OVERALL EXTERIOR	CASE LBS. (CUBE)	LIST PRICE EA.
Divider Bars			
DIV12	12¾" (Length)	1 (0.02)	\$ 4.00

Case Pack: 3

Colors: White (148), Clear (135).

Insulated Food Servers (Non-Electric)



Multiple GN Food Pans, Front-loading Carriers

- Durable and dependable front-loading food pan carriers.
- Hold multiple pans of hot or cold food at safe temperatures for 4 hours or more.
- Seamless polyethylene with thick polyurethane foam insulation.

300MPC Colors: Navy Blue (186), Slate Blue (401), Coffee Beige (157), Dark Brown (131), Brick Red (402), Green (519), Black (110), Hot Red (158).

Note: Place food pans on rails. Pans should not be placed on the floor of a Camcarrier® cavity. Please use specified food pan sizes.

Note: If using metal food pans, cool to 250°F before placing onto rails.



CODE	300MPC
EXTERIOR DIM. W x D x H	16½" x 24" x 23⅝"
INTERIOR DIM. W* x D x H	13¾" x 21" x 14"
FITS CAMDOLLY®	CD300, CD400
CASE LBS (CUBE)	30.17 (5.7)
LIST PRICE EACH	\$ 480.00

Case Pack: 1 **InStock Colors:** Dark Brown (131), Black (110). * Rail to Rail **Temperature Maintenance Tools:** 1210PW Camwarmer®, 300DIV ThermoBarrier®, CP1220 and CP1210 Camchiller®. Refer to page 153 for Camdollies listing.

Hot — temperature loss averaging 3°F/hour.

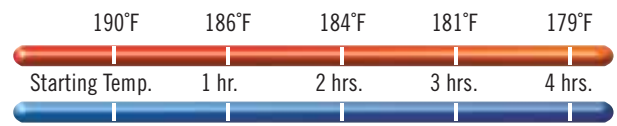

Cold — temperature gain averaging 1.5°F/hour.

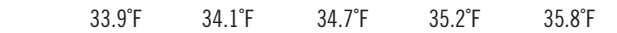

300MPC Holding Capacity

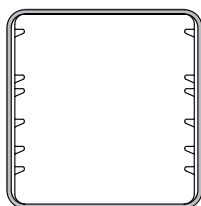

300MPC Rail Configuration

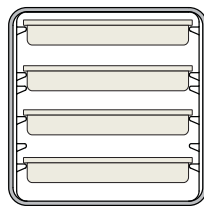

4 x 2½" (6,5 cm)

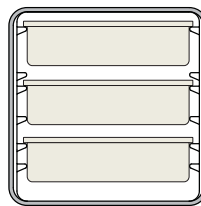

3 x 4" (10 cm)

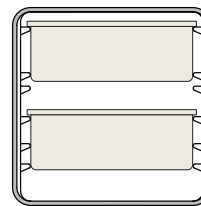

2 x 6" (15 cm)

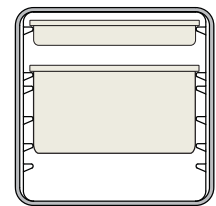

1 x 8" (20 cm)
and 1 x 2½" (6,5 cm)

Insulated Food Servers (Non-Electric)



Ultra Pan Carrier® UPC400

Colors: Navy Blue (186), Slate Blue (401), Cold Blue (159), Coffee Beige (157), Dark Brown (131), Black (110), Granite Gray (191), Granite Green (192), Granite Sand (194).

UPC400 is covered by US Patent D 392,158. Venting plug is covered by US Patent D 553,717 S.

Both Carriers:

- Fit four 4" deep full-size food pans.
- Hold hot or cold food safely for 4 hours or more.

Note: Place food pans on rails. Pans should not be placed on the floor of a Camcarrier® cavity. Please use specified food pan sizes.

Note: If using metal food pans, cool to 250°F before placing onto rails.



Ultra Pan Carrier® S-Series UPCS400

Colors: Slate Blue (401), Speckled Gray (480), Dark Brown (131).

PRESSURE AND HUMIDITY CONTROL
Pop-up vent.



REMOVABLE GASKET
Provides an airtight seal.

MENU CLIP
Reduces need to open door.



BUILT-IN SEAL
Eliminates need for removable gasket.

PRESSURE CONTROL
Built-in vent.

CODE	UPC400 / UPC400TR**
EXTERIOR DIM. W x D x H	18" x 25" x 24 1/2"
INTERIOR DIM. W* x D x H	13 1/2" x 21" x 19 1/2"
FITS CAMDOLLY®	CD300, CD400
CASE LBS (CUBE)	33.23 (7.00)
LIST PRICE EACH	\$ 565.00 / \$ 590.00

Case Pack: 1 InStock Colors: Coffee Beige (157), Black (110).
Temperature Maintenance Tools: 1210PW Camwarmer®, 300DIV ThermoBarrier®, 400DIV ThermoBarrier, CP1220 and CP1210 Camchiller®.

Refer to page 153 for Camdollies listing.

* Rail to Rail

**Tamper Resistant Model: Tamper-resistant screws. Non-removable doors. Locking hasp (optional item) for padlocks (not included).

CODE	UPCS400
EXTERIOR DIM. W x D x H	18" x 26 1/4" x 25"
INTERIOR DIM. W x D x H	13 1/2" x 21" x 19 1/2"
FITS CAMDOLLY	CD400
CASE LBS. (CUBE)	47.50 (7.38)
LIST PRICE EACH	\$ 515.00

Case Pack: 1 InStock Colors: Speckled Gray (480), Dark Brown (131).
Temperature Maintenance Tools: 1210PW Camwarmer, 400DIV ThermoBarrier, CP1220 and CP1210 Camchiller. Refer to page 153 for Camdollies listing.

Hot — temperature loss averaging 3°F/hour.

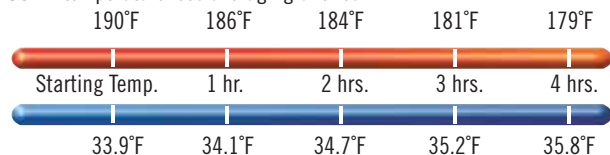

Cold — temperature gain averaging 1.5°F/hour.

Full Size Food Pan Holding Capacity UPC400 / UPCS400:

Also holds 1/2 and 1/3 size pans.

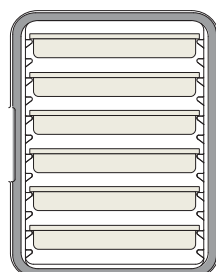

6 x 2 1/2" (6,5 cm)

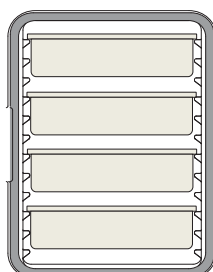

4 x 4" (10 cm)

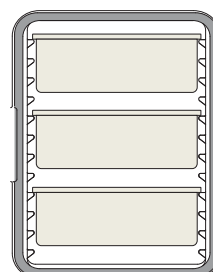

3 x 6" (15 cm)

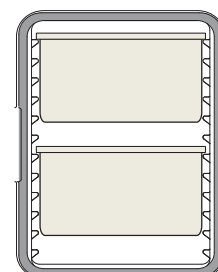

2 x 8" (20 cm)

Camdollies® for Insulated Beverage Servers and Carriers

With Handles



CD100H
External Dim.:
 W 19 $\frac{3}{4}$ " x D 33 $\frac{3}{8}$ " x H 36 $\frac{1}{4}$ "
Interior Dim.: W 17 $\frac{1}{4}$ " x D 26 $\frac{7}{16}$ "
Case Lbs. (Cube): 33.8 (12.71)
Capacity: 350 Lbs.
Caster Type: A
List Price Each: \$ 490.00



CD300H
External Dim.:
 W 19" x D 30 $\frac{3}{8}$ " x H 36 $\frac{1}{4}$ "
Interior Dim.: W 16 $\frac{3}{16}$ " x D 23 $\frac{1}{16}$ "
Case Lbs. (Cube): 33 (12.07)
Capacity: 350 Lbs.
Caster Type: A
List Price Each: \$ 480.00



CD1826H
External Dim.:
 W 20 $\frac{3}{8}$ " x D 31 $\frac{1}{2}$ " x H 38 $\frac{1}{2}$ "
Interior Dim.: W 18 $\frac{1}{2}$ " x D 26 $\frac{1}{8}$ "
Case Lbs. (Cube): 33.75 (12.82)
Capacity: 300 Lbs.
Caster Type: A
List Price Each: \$ 510.00



CD1826MTC
External Dim.:
 W 23 $\frac{1}{16}$ " x D 35 $\frac{3}{8}$ " x H 36 $\frac{1}{2}$ "
Interior Dim.: W 22" x D 28 $\frac{1}{2}$ "
Case Lbs. (Cube): 35 (17.40)
Capacity: 350 Lbs.
Caster Type: A
List Price Each: \$ 555.00

Big Rear Wheels



CD100HB
External Dim.:
 W 23 $\frac{1}{2}$ " x D 32 $\frac{3}{8}$ " x H 36 $\frac{1}{2}$ "
Interior Dim.: W 17 $\frac{1}{2}$ " x D 26 $\frac{3}{8}$ "
Case Lbs. (Cube): 45 (18.51)
Capacity: 350 Lbs.
Caster Type: C
List Price Each: \$ 595.00



CD300HB
External Dim.:
 W 23 $\frac{1}{2}$ " x D 29 $\frac{3}{8}$ " x H 36 $\frac{1}{2}$ "
Interior Dim.: W 17 $\frac{1}{4}$ " x D 23 $\frac{3}{8}$ "
Case Lbs. (Cube): 46 (18.11)
Capacity: 350 Lbs.
Caster Type: C
List Price Each: \$ 570.00



CD1826HB
External Dim.:
 W 23 $\frac{3}{8}$ " x D 33 $\frac{1}{2}$ " x H 36 $\frac{1}{2}$ "
Interior Dim.: W 18 $\frac{1}{2}$ " x D 26 $\frac{1}{8}$ "
Case Lbs. (Cube): 47 (18.29)
Capacity: 300 Lbs.
Caster Type: C
List Price Each: \$ 635.00



CD1826MTCB
External Dim.:
 W 27 $\frac{1}{2}$ " x D 34 $\frac{3}{8}$ " x H 36 $\frac{1}{2}$ "
Interior Dim.: W 21 $\frac{3}{8}$ " x D 28 $\frac{3}{16}$ "
Case Lbs. (Cube): 41.8 (21.43)
Capacity: 350 Lbs.
Caster Type: C
List Price Each: \$ 700.00

Without Handles



CD100
External Dim.:
 W 19 $\frac{3}{8}$ " x D 28 $\frac{3}{8}$ " x H 10 $\frac{1}{2}$ "
Interior Dim.: W 17 $\frac{1}{4}$ " x D 26 $\frac{3}{16}$ "
Case Lbs. (Cube): 17.5 (3.33)
Capacity: 300 Lbs.
Caster Type: A
List Price Each: \$ 305.00



CD160
External Dim.:
 W 16 $\frac{1}{16}$ " x D 24 $\frac{3}{8}$ " x H 10 $\frac{3}{8}$ "
Interior Dim.: W 14 $\frac{1}{16}$ " x D 21 $\frac{1}{16}$ "
Case Lbs. (Cube): 19 (2.30)
Capacity: 300 Lbs.
Caster Type: A
List Price Each: \$ 305.00



CD300
External Dim.:
 W 23 $\frac{1}{2}$ " x D 32 $\frac{3}{8}$ " x H 36 $\frac{1}{2}$ "
Interior Dim.: W 17 $\frac{1}{2}$ " x D 26 $\frac{3}{8}$ "
Case Lbs. (Cube): 45 (18.51)
Capacity: 350 Lbs.
Caster Type: A
List Price Each: \$ 305.00



CD400
External Dim.:
 W 20 $\frac{3}{8}$ " x D 27 $\frac{3}{8}$ " x H 9"
Interior Dim.: W 18 $\frac{1}{8}$ " x D 25"
Case Lbs. (Cube): 19.60 (3.35)
Capacity: 300 Lbs.
Caster Type: A
List Price Each: \$ 335.00



CD1420
External Dim.:
 W 16 $\frac{1}{4}$ " x D 21 $\frac{3}{4}$ " x H 8 $\frac{5}{16}$ "
Interior Dim.: W 13 $\frac{3}{8}$ " x D 19 $\frac{1}{16}$ "
Case Lbs. (Cube): 15.25 (1.44)
Capacity: 350 Lbs.
Caster Type: B
List Price Each: \$ 275.00

Optional Accessories



DIV12
Dimension: 12 $\frac{3}{4}$ " Length
Case Lbs. (Cube): 1 (0.02)
List Price Each: \$ 4.00
 1.800.833.3003



UPCS400CK (Caster Kit)
Dimension: 5"
Case Lbs. (Cube): 9.40 (0.21)
List Price Each: \$ 135.00



400STP (Strap)
Dimension: 150" Long
List Price Each: \$ 15.00

UTHSTP (Strap)
Dimension: 200" Long
List Price Each: \$ 17.00



1826HAR (Lifting Harness)
Dimension: 142" Long
List Price Each: \$ 90.00

Camdolly® Colors:
 Coffee Beige (157), Dark Brown (131),
 Black (110), Slate Blue (401),
 Gray (180).
CD400 InStock Colors:
 Black (110), Dark Brown (131).
Caster Type:
(A) 5" Casters, 2 fixed, 2 swivel,
 1 with brake.
(B) 3" Casters, 2 fixed, 2 swivel,
 1 with brake.
(C) 10" Rear Big Wheels, 2 front 5"
 swivel casters, 1 with brake.

Insulated Food Servers (Non-Electric)



Multiple GN Food Pan, Front-Loading Carts

- Double-compartment, high-capacity carts hold and transport hot or cold food.
- Tough, polyethylene shell and thick foam insulation throughout cabinet and between compartments maintain safe food temperatures for 4 hours or more.
- Easy to maintain and won't dent, crack, rust, or chip.
- Durable nylon door latches open easily and close securely.
- Full-swing doors open to the side of the cart for easy loading and unloading.
- Airtight removable gaskets
- Molded-in handles ensure easy maneuvering.
- Molded-in bumpers minimize damage to walls, furniture and other equipment.

Colors: Navy Blue (186), Slate Blue (401), Coffee Beige (157), Dark Brown (131), Brick Red (402), Green (519), Black (110), Hot Red (158), Granite Gray (191), Granite Green (192), Granite Sand (194).

Note: Place food pans on rails. Pans should not be placed on the floor of a Camcart cavity. Please use specified food pan sizes.

Note: If using metal food pans, cool to 250°F before placing onto rails.

Venting plug is covered by US Patent D 553,717 S.

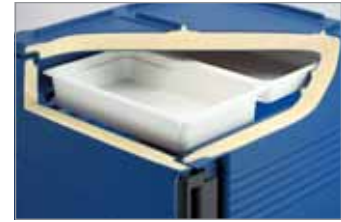

Polyurethane insulation keeps hot food hot and cold food cold.



Shown with optional HD casters.



Tamper-Resistant models

are specifically designed for operations where safety and security are a top priority.

These models feature components that withstand severe conditions without safety risks: Tamper-resistant screws on latches. Non-removable doors. Casters and chassis plates mounted with tamper-resistant bolts. Locking hasp (optional item) for padlocks (not included).

Marine rail is designed for use during service, not transport.



TOTAL CART HOLDING CAPACITY	UPC600	UPC800	UPC1200	UPC1600
Full Size Food Pans				
2½" deep	8 pans	12 pans	16 pans	24 pans
4" deep	6 pans	8 pans	12 pans	16 pans
6" deep	4 pans	6 pans	8 pans	12 pans
8" deep	2 pans + 2 each 4" pans	4 pans	4 pans	8 pans
Camtray®*				
3253	12 trays	24 trays	24 trays	48 tray
2632	24 trays	48 tray	—	—
2025	—	—	12 trays	24 trays

See Food Pan and Camtray® Section for pricing and ordering information.

*Based on 3" spacing between trays.

Hot — temperature loss averaging 3°F/hour.

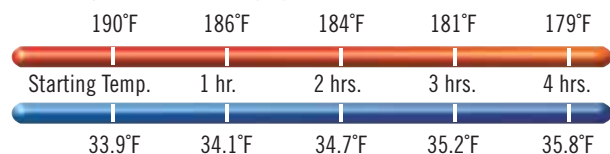

Cold — temperature gain averaging 1.5°F/hour.

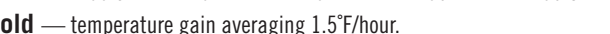

Insulated Food Servers (Non-Electric)



Ultra Camcarts®



CODE	UPC600	UPC800 / UPC800TR	UPC1200	UPC1600	UPC1600HD	UPC1600TR*
DESCRIPTION	Base Model	Base Model / Tamper Resistant	Base Model	Base Model	Base Model with HD Casters	Tamper Resistant
EXTERIOR DIM. W x D x H	20½" x 27½" x 45"	20½" x 27½" x 54"	28½" x 32¼" x 45½"	28¾" x 33¾" x 54½"	28¾" x 33¾" x 54½"	28¾" x 33¾" x 54½"
COMPARTMENT DIMENSIONS	13⅝" x 21⅝" x 14"	13" x 21½" x 19⅝"	21⅞" x 26⅞" x 13½"	21" x 26⅞" x 21"	21" x 26⅞" x 21"	21" x 26⅞" x 21"
CASTERS	5" x 1¼" Casters	6" x 1¼" Casters	6" x 1¼" Casters	6" x 1¼" Casters	6" x 2" HD Casters	6" x 2" HD Casters
CASE LBS. (CUBE)	71.6 (15.96)	86 (19.28)	108.67 (25.74)	130 (35.33)	139.5 (35.33)	141 (35.33)
TEMPERATURE MAINTENANCE TOOLS	1210PW Camwarmer®, 300DIV ThermoBarrier®, CP1220 and CP1210 Camchiller®	1210PW Camwarmer, 400DIV ThermoBarrier, CP1220 and CP1210 Camchiller	1200DIV Thermo Barrier, CP1220 Camchiller	1600DIV Thermo Barrier, CP1220 Camchiller	1600DIV ThermoBarrier, CP1220 Camchiller	1600DIV ThermoBarrier, CP1220 Camchiller
LIST PRICE EACH	\$ 1,190.00	\$ 1,405.00 / \$ 1,415.00	\$ 1,825.00	\$ 2,635.00	\$ 2,775.00	\$ 2,675.00

Case Pack: 1 Casters: 5" or 6" x 1¼", 2 fixed, 2 swivel, 1 with brake. HD: Heavy-duty, hi-modulus 6" x 2" 2 fixed, 2 swivel with brake casters. *Comes with HD casters.

Combo Carts™

- Use to hold full-size sheet pans or hotel pans of hot or cold food.
- Easy-to-adjust aluminum rails.
- Tough, rotationally molded polyethylene with thick foam insulation.
- Airtight removable gasket provides a secure seal.
- Doors swing open to the side of the cart for easy loading and unloading.
- Molded-in, full-length handle on the back for easy maneuvering.
- Easy to clean.

Colors: Gray (180), Dark Brown (131).

Casters: 5", 2 swivel with brakes & two 10" Wheels.

* Complete with tamper-resistant hardware for maximum security applications.

Venting plug is covered by US Patent D 553,717 S.



CMB1826L



Easy-to-adjust rails hold sheet pans or full-size hotel pans (all depths).



Capacity: Holds up to 12 each 18" x 26" sheet pans or 24 each 13" x 18" sheet pans per compartment.



Capacity: Each compartment holds up to 12 each full size 2½" deep Food Pans (2 pans per rail).

CODE	DESCRIPTION	OVERALL DIMENSIONS	PER CAVITY INSIDE DIMENSIONS W x D x H	CASE LBS. (CUBE)	LIST PRICE EA.
CMB1826L	½ Size Combo Cart, Low	25¼" x 32⅞" x 37⅞"	22" x 26½" x 22½"	144 (19.82)	\$ 3,185.00
CMB1826LSP*	½ Size Combo Cart with Security Hardware	25¼" x 32⅞" x 37⅞"	22" x 26½" x 22½"	144 (19.82)	3,475.00

Case Pack: 1

1.800.833.3003

Insulated Food Servers (Non-Electric)

Combo Cart™ Plus, Non-Electric

- The most versatile insulated transporter on the market! Holds food pans, sheet pans, trays and even large pizza boxes.
- Two separate compartments offer the flexibility of holding either hot or cold food.

- Tough, durable polyethylene exterior will not dent, rust or chip—a great alternative to metal holding carts!
- Thick, CFC-free polyurethane insulation throughout the cabinet ensures excellent food quality and temperature retention for 4 or more hours.
- Ideal for caterers, schools, hotels and large institutions.

Color: Charcoal Gray (615).

Note: Place food pans on rails. Pans should not be placed on the floor of the compartment. All food should be cooled to 250°F before placing into cart to avoid damage to the body.



STAINLESS STEEL UNIVERSAL RAILS
Holds sheet pans, food pans, pizza boxes and trays (or limitless combinations of these!)

GASKET-FREE DOOR
Worry free door! Swings open completely to the side.

MENU POCKET
Allows for easy product ID with either an index card or by writing directly onto smooth surface with a grease pencil.

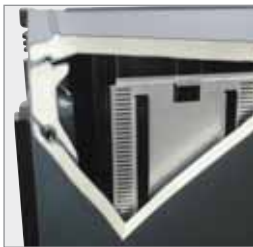

INSULATION
CFC-free, polyurethane insulation throughout the body and doors maximizes heat or cold retention for 4 hours or more.



MARINE RAILING
Creates a bonus staging area for food pans.



ERGONOMIC VERTICAL MOLDED-IN HANDLES
Will never break; great for maneuvering by operators of all heights.

WIDE PADDLE LATCHES
For easy opening and closing.

PERIMETER BUMPER
Protects cart and walls.

CASTERS
All swivel with brakes for smooth positioning and navigation; non-marking.

Insulated Food Servers (Non-Electric)

Combo Cart™ Plus, Non-Electric

CODE	CASTER TYPE	UNIT WEIGHT LBS.	CASE LBS. (CUBE)	LIST PRICE EA.
CMBP	Standard Casters	210	230.5 (42.5)	\$ 5,450.00
CMBPHD	Heavy Duty Casters	219.5	240 (42.5)	5,590.00
Security Package				
CMBPSP	Standard Casters	211	231.5 (42.5)	5,970.00
CMBPSPHD	Heavy Duty Casters	220.5	241 (42.5)	6,110.00

Standard Caster: 6" x 1¼" (all swivel, with brakes) **Exterior Dimensions (W x D x H):** 27½" x 33½" x 65½"
Heavy Duty Caster: 6" x 2" (all swivel, with brakes) **Compartment Dimensions with column rails (W x D x H):** 21½" x 26¼" x 25½"
Case Pack: 1 **Color:** Charcoal Gray (615).

Security Package

Tamper-resistant screws on the latch handle assembly. Non-removable retainer rings on each hinge pin make doors non-removable. Built-in hasp for a transit seal or certain types of padlocks. Tamper-resistant fasteners for columns and cross-locking wires behind the columns lock the rails into place.

Optional Accessories

CODE	CMBPR1	CMBPR7
DESCRIPTION	1 Pair of Rails	7 Pair of Rails
CASE LBS. (CUBE)	4.12 (0.13)	27.75 (0.47)
LIST PRICE EACH	\$ 78.00	\$ 500.00

Case Pack: 1 **Color:** (000).



Holding Capacity Reference

TYPE OF CONTAINER	STANDARD CAPACITY	RAIL SPACING	MAXIMUM CAPACITY	RAIL SPACING
18" x 26" FULL SIZE SHEET PANS	14	3⅞"	32*	1½"
13" x 18" FULL SIZE SHEET PANS	28	3⅞"	64*	1½"
2½" DEEP HOTEL PANS	28	3⅞"	28	3⅞"
4" DEEP HOTEL PANS	20**	5"	20	5"
40 x 60 CM TRAYS	14	3⅞"	32*	1½"
32,5 x 53 CM TRAYS	28	3⅞"	52*	1½"
16" x 16" x 2" PIZZA BOXES	14	3⅞"	22	2¼"

* Additional rails required.

** Only requires 5 pairs of rails.

Insulated Food Servers (Non-Electric)



Sheet Pans & Trays, GN Food Pans or Food Boxes



1318MTC

Camcarrier for Half-size Sheet Pans, Full-size Food Pans, and Trays

- Holds up to 8 each 13" x 18" sheet pans or 3 each full-size deep food pans.
- Molded-in handles.
- Stackable for storage and transport.
- Fits CD300 Camdolly.



1826LBC

Camcart for Food Storage Boxes

- Holds 18" x 26" Food Storage Boxes.
- 13 supports on 1 $\frac{1}{4}$ " centers.
- Includes removable cutting board on top.



1826MTC

Camcarrier for Trays and Sheet Pans

- Holds up to 6 each 18" x 26" sheet pans.
- Six tray supports on 2 $\frac{1}{8}$ " centers.
- Molded-in handles.
- Fits CD1826MTC Camdolly.



1826LTC3

Camcart for Trays and Sheet Pans

- Holds up to 7 each 18" x 26" trays or sheet pans.
- Seven tray supports on 3 $\frac{1}{4}$ " centers for 3" clearance between trays.
- Includes removable cutting board on top.



1826LTCSP

Camcart with Security Package

- Specially designed for high security applications.
- Features tamper-resistant hardware to protect both cart and contents.
- Includes removable cutting board on top.



1826LTC

Camcart for Trays and Sheet Pans

- Holds up to 13 each 18" x 26" trays or sheet pans.
- Thirteen tray supports on 1 $\frac{1}{4}$ " centers.
- Includes removable cutting board on top.

Colors: Slate Blue (401), Gray (180), Coffee Beige (157), Dark Brown (131), Navy Blue (186).

1826MTC is available in Black (110).
1318MTC not available in Gray (180).
Strap Color: Beige (000).

Refer to page 153 for Camdollies listing.

CD1826MTC: 5" Casters: 2 fixed, 2 swivel, 1 with brake.

CD1826MTCCHB: 5" Casters: 2 swivel, 1 with brake and 2, 10" Easy Wheels.

* With handle.

** Cart comes complete with tamper-resistant hardware for maximum security applications.

6" Casters: 2 fixed, 2 swivel, 1 with brake.

Note: Cool metal sheet pans to 250°F before placing onto tray supports.



CODE	DESCRIPTION	EXTERIOR DIMENSIONS D* x W x H	INTERIOR DIMENSIONS D x W x H	CASE LBS. (CUBE)	LIST PRICE EA.
1318MTC	For trays & $\frac{1}{2}$ sheet pans	16 $\frac{1}{2}$ " x 24" x 23 $\frac{3}{16}$ "	13 $\frac{3}{8}$ " x 21" x 14"	31.50 (5.74)	\$ 495.00
1826MTC	For trays & sheet pans	29 $\frac{1}{4}$ " x 21 $\frac{1}{2}$ " x 22 $\frac{1}{2}$ "	26 $\frac{1}{8}$ " x 18 $\frac{3}{8}$ " x 13 $\frac{1}{4}$ "	41.33 (8.67)	740.00
Camdolly					
CD1826MTC	Camdolly for 1826MTC	35 $\frac{1}{8}$ " x 23 $\frac{15}{16}$ " x 35 $\frac{3}{4}$ "	28 $\frac{1}{2}$ " x 22"	35 (17.40)	555.00
CD1826MTCCHB	Camdolly with Easy Wheels for 1826MTC	34 $\frac{7}{8}$ " x 27 $\frac{1}{2}$ " x 36 $\frac{3}{4}$ "	28 $\frac{3}{16}$ " x 21 $\frac{1}{8}$ "	41.8 (21.43)	700.00
Camcarts					
1826LTC	For trays & sheet pans	32" x 21 $\frac{1}{2}$ " x 37 $\frac{1}{2}$ "	26 $\frac{1}{8}$ " x 18 $\frac{3}{8}$ " x 26 $\frac{1}{4}$ "	86 (16.39)	1,425.00
1826LTC3	For trays & sheet pans	32" x 21 $\frac{1}{2}$ " x 37 $\frac{1}{2}$ "	26 $\frac{1}{8}$ " x 18 $\frac{3}{8}$ " x 26 $\frac{1}{4}$ "	86 (16.39)	1,425.00
1826LBC	For Food Storage Boxes	32" x 21 $\frac{1}{2}$ " x 37 $\frac{1}{2}$ "	26 $\frac{1}{8}$ " x 18 $\frac{3}{8}$ " x 26 $\frac{1}{4}$ "	86 (16.39)	1,410.00
Camcarts with Security Package**					
1826LTCSP	For trays & sheet pans	32" x 21 $\frac{1}{2}$ " x 37 $\frac{1}{2}$ "	26 $\frac{1}{8}$ " x 18 $\frac{3}{8}$ " x 26 $\frac{1}{4}$ "	86 (16.39)	1,655.00
1826LBCSP	For Food Storage Boxes	32" x 21 $\frac{1}{2}$ " x 37 $\frac{1}{2}$ "	26 $\frac{1}{8}$ " x 18 $\frac{3}{8}$ " x 26 $\frac{1}{4}$ "	86 (16.39)	1,625.00
Securing Strap					
1826STP	Securing Strap	142" L	—	4.80 (0.58)	90.00

Case Pack: 1 Venting plug is covered by U.S. Patent D 553,717S.

Insulated Food Servers (Non-Electric)



Camcarts®

- Use to hold hot or cold bulk food stored on trays, sheet pans or in food boxes.
- Durable polyethylene and thick foam insulation retain safe food temperatures.
- Sturdy plastic, rust-proof latches are secured into molded-in mounting plates.
- Molded-in handle on the back for easy maneuvering.



Colors: Slate Blue (401), Coffee Beige (157), Dark Brown (131), Gray (180).

6" Casters: 2 fixed, 2 swivel, 1 with brake.

Note: Cool metal sheet pans to 250°F before placing onto tray supports.

Venting plug is covered by US Patent D 553,717 S.

Only 1826DBC is NSF Listed.



1826DTC Double Cavity Cart for Trays and Sheet Pans

Capacity: 24 tray support rails on 1⁵/₁₆" centers (12 per cavity). Holds up to 24 each 18" x 26" (46 x 66 cm) trays or sheet pans.

1826DBC Double Cavity Cart for Food Storage Boxes

Capacity: 26 support rails on 1³/₄" centers (13 per cavity). Holds 18" x 26" (46 x 66 cm) Food Storage Boxes.

Camcart with Security Package

Specially designed for high security applications, with tamper-resistant hardware: metal hinges with non-removeable pins, metal latches with welded bails, lockable hasp and no chassis plate.



Caster Impact Plates

Impact plates add metal reinforcement to hold casters in place even when dropped.

CODE	DESCRIPTION	EXTERIOR DIMENSIONS W x D x H	INTERIOR DIMENSIONS W x D x H	CASE LBS. (CUBE)	LIST PRICE EA.
1826DTC	For trays & sheet pans	33 ³ / ₄ " x 21 ¹ / ₂ " x 63 ³ / ₄ "	26 ¹ / ₂ " x 18 ³ / ₄ " x 25 ⁷ / ₁₆ "	135 (27.92)	\$ 2,355.00
1826DBC	For food storage boxes	33 ³ / ₄ " x 21 ¹ / ₂ " x 63 ³ / ₄ "	26 ¹ / ₂ " x 18 ³ / ₃₂ " x 25 ⁷ / ₁₆ "	135.50 (28.35)	2,355.00
Camcarts with Security Package					
1826DTCSP	For trays & sheet pans	33 ³ / ₄ " x 21 ¹ / ₂ " x 63 ³ / ₄ "	26 ¹ / ₂ " x 18 ³ / ₄ " x 25 ⁷ / ₁₆ "	135 (27.92)	2,880.00
1826DBCSP	For food storage boxes	33 ³ / ₄ " x 21 ¹ / ₂ " x 63 ³ / ₄ "	26 ¹ / ₂ " x 18 ³ / ₃₂ " x 25 ⁷ / ₁₆ "	143.8 (27.99)	2,860.00

Case Pack: 1 *Depth measurement includes handle.

Temperature Maintenance Tools



Camchiller®

- An easy-to-use, cold food holding temperature tool.
- Extend cold holding time or enhance safe holding below 41°F (5°C) when frequent access is required.
- Freeze first then use to pre-chill cabinet before loading.



Cold — temperature gain averaging 1.5°F/hour.

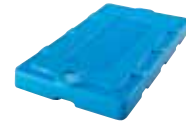
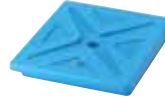
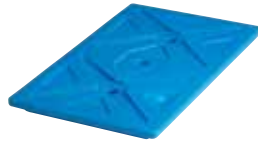
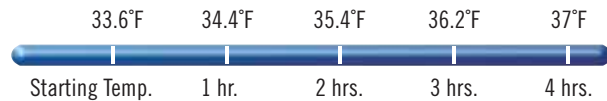

CODE	CP1220 (GN FULL SIZE)	CP1210 (GN HALF SIZE)	CP814 (8 x 14 CAMCHILLER)
FITS INTO	Insulated Transporters: 300MPC, UPC400, UPSC400, UPC600, UPC800, UPC1200, UPC1600, 1318MTC, UPSS160 Camcruisers®: CVC72*, CVC724* Combo Carts™: All Models CamKiosk®*: All Models	Insulated Transporters: 125MPC, 140MPC, 150MPC, 160MPC, 180MPC, 300MPC, UPC140, UPC160, UPC180, UPC400, UPSC400, UPC600, UPC800, UPSC140, UPSC160, UPSC180, 1318MTC Camcruisers®: CVC72*, CVC724* CamKiosk®*: All Models	Food Boxes: 12189CW, 12189P, 12186CW, 12186P Camcruisers®: CVC55, CVC72*, CVC724* CamKiosk®*: All Models
QUANTITY PER CAVITY	1 (2 per cabinet recommended*)	1 or 2	1
DIMENSIONS L x W x H	20 ³ / ₁₆ " x 12 ⁷ / ₈ " x 1 ¹ / ₂ "	10 ³ / ₈ " x 12 ³ / ₄ " x 1 ¹ / ₂ "	14" x 8" x 1 ¹ / ₂ "
CASE LBS. (CUBE)	8.15 (0.32)	3.8 (0.18)	3.8 (0.19)
LIST PRICE EACH	\$ 130.00	\$ 67.00	\$ 67.00

Case Pack: 1 InStock Color: Cold Blue (159). *Top wells only

ThermoBarrier®

- A highly valuable yet economical temperature maintenance tool for caterers.
- Use to minimize empty space and food temperature loss within a partially loaded compartment.

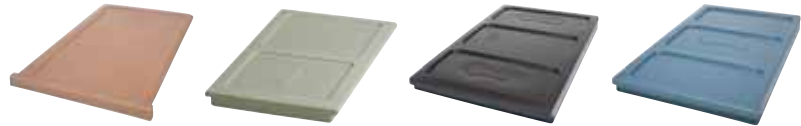

CODE	300DIV	400DIV	1200DIV	1600DIV
FITS INTO	300MPC, UPC600, 1318MTC	UPC400, UPC800, UPC400TR, UPSC400, UPC800TR	UPC1200, CVC72, CVC724	UPC1600, CamKiosk
QUANTITY PER COMPARTMENT	1	1	2	2
DIMENSIONS L x W x H	20 ¹³ / ₁₆ " x 12 ¹⁵ / ₁₆ " x 1"	21 ¹ / ₄ " x 13" x 1 ¹ / ₂ "	20 ⁷ / ₈ " x 12 ⁷ / ₈ " x 1 ³ / ₈ "	20 ⁷ / ₈ " x 13 ¹ / ₈ " x 1 ¹ / ₂ "
COLOR	Coffee Beige (157)	Gray (180)	Dark Brown (131)	Slate Blue (401)
CASE PACK	1	1	2	2
CASE LBS. (CUBE)	3.33 (0.31)	3.60 (0.35)	7.75 (0.67)	6.17 (0.55)
LIST PRICE EACH	\$ 75.00	\$ 75.00	\$ 75.00	\$ 75.00

InStock Colors: Coffee Beige (157), Gray (180).

Camwarmer®

- Added insurance to keep hot foods hot during holding and transporting.
- Keep in cabinet with hot foods to extend holding time or enhance safe holding above 140°F (65°C) when frequent access is required.



CODE	1210PW
FITS INTO	UPC400, UPSC400, UPC600, UPC800, 300MPC, 1318MTC
DIMENSIONS L x W x H	13 ¹ / ₄ " x 10 ⁷ / ₈ " x 1 ¹ / ₁₆ "
CASE LBS. (CUBE)	3.80 (0.17)
LIST PRICE EACH	\$ 190.60

Case Pack: 1 InStock Color: Granite Gray (191).



UPC400 with Camwarmer.
Two Camwarmers recommended per cavity. Place on bottom rail and store hot food above.



Temperature Maintenance – Optimize Food Holding Performance.

Camchiller – GN Full Size and Half Size

- Use to:
 - Pre-chill cabinet cavity.
 - Hold packaged food in food pan wells (Half Size Only).
 - Maximize cold food holding.
 - Minimize open cavity space.
- Easy to use:
 1. Freeze flat for 8 hours.
 2. Slide one or two on top rails and pre-chill cavity 15-20 minutes.
 3. Load in pans of pre-chilled food below Camchiller. (A)
 4. Move pans and Camchiller down as food is removed. (B)

COLD HOLDING

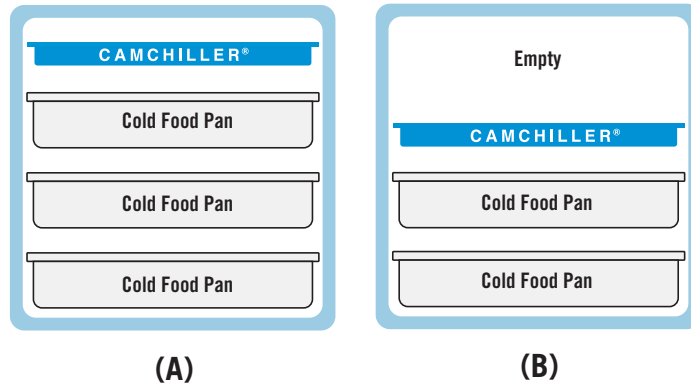

ThermoBarrier – Full Size

- Use to:
 - Hold hot and cold food in same cabinet cavity.
 - Minimize open cavity space.
- Easy to use:
 1. Slide between hot food on top and cold food on bottom. (A)
 2. Slide under hot food loaded in upper cavity space. (B)
 3. Slide above cold food loaded into lower cavity space. (C)

HOT AND COLD HOLDING

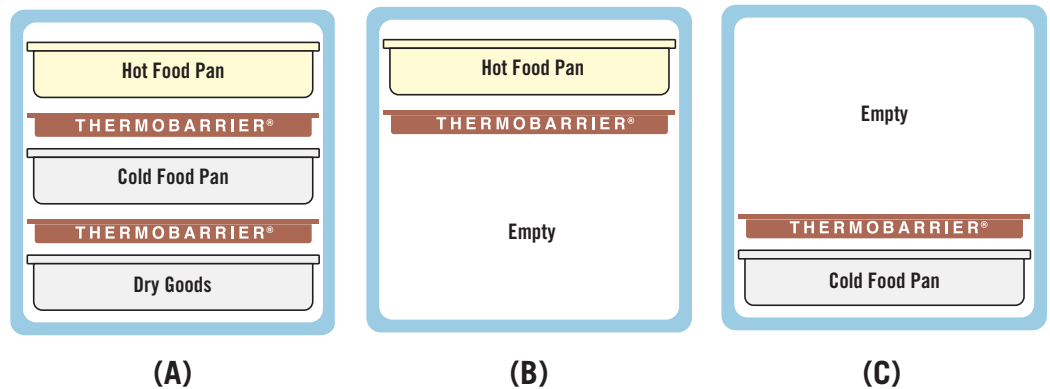

Camwarmer – Half Size

- Use to:
 - Pre-heat cabinet cavity.
 - Maximize hot food holding.
 - Minimize open cavity space.
- Easy to use:
 1. Heat in 350°F (180°C) oven for 45 minutes.
 2. Slide two Camwarmers on bottom rails and pre-heat cavity 15-20 minutes. (or place on high heat food pan lid or sheet pan)
 3. Load in pans of pre-heated food above Camwarmers. (A)
 4. Move pans and Camwarmers up as food is removed. (B)

HOT HOLDING

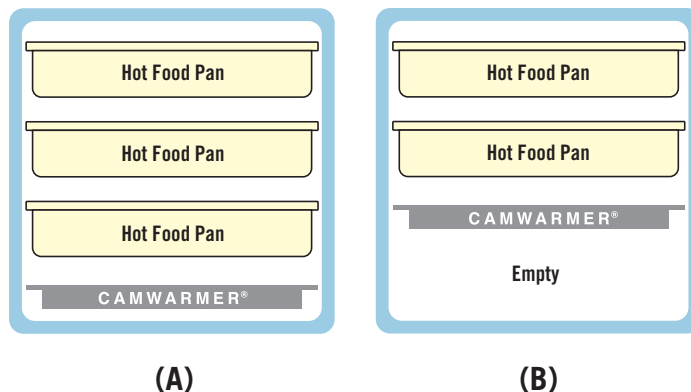

Insulated Food Servers (Electric)

Ultra Pan Carrier® and Ultra Camcart® H-Series

- Designed for both electric hot holding and non-electric transport.
- Gentle, 150° to 165°F non-radiant heat will not cook food and maintains food moisture.
- Holds a wide variety of foods such as pasta, bone-in fried chicken, and double-crust pies.

- One hour preheat time from room temperature and three minute recovery.
- Energy consumption is substantially less than comparable metal cabinets.
- Will not rust or dent like metal cabinets, is more economical, and is easy to maneuver.

- All UPCH models have been tested to maintain at safe, hot food temperatures, for up to 4 hours when unplugged.
- Models with only the top heated door offer unique versatility with an electric hot holding cabinet on top and passive hot or cold food holding on the bottom.

- Heated door kits also sold separately to retrofit UPC400, UPC800 and UPC1600.

Colors: Granite Gray (191), Granite Green (192), Slate Blue (401), Dark Brown (131), Black (110).

Casters: 6" - 2 fixed, 2 swivel, 1 with brake.



Power On and Heat On Indicators

Communicate the Power and Heating status of the UPCH1600 unit. Know instantly when the compartment has reached target temperature.



Vents

Consistent heating throughout the compartment is generated by vents that constantly circulate heat from front to back.



Tough Exterior

All UPCH units are made of tough polyethylene with polyurethane foam insulation to keep heat in while keeping the exterior cool to the touch. Will not crack, dent, chip, rust or break.



Insulation

CFC-free, foamed-in place polyurethane foam insulation will hold temperature above 148°F for up to 4 hours when used unplugged.

Insulated Food Servers (Electric)

Ultra Pan Carrier® and Ultra Camcart® H-Series

Marine rail is designed for use during service, not transport.



MODEL	UPCH400/ UPCH800 (110 VAC MODELS)	UPCH4002/ UPCH8002 (220 VAC MODELS)	UPCH1600 (110 VAC MODELS)	UPCH16002 (220 VAC MODELS)
Electrical Specifications				
Required Voltage	110 - 120 VAC	200 - 230 VAC	110 - 125 VAC	200 - 230 VAC
Maximum Amp.	2.0a	1.2a	4.6a	1.2a
Watts	230w	265w	529w	265w
Hertz	50/60	50/60	50/60	50/60
Plug Type	Nema 5-15P	Euro plug, CEE7	5-15P to C15RA	CEE7/7 to C15RA
Power Cord Length	9 feet	2,7 m	9 feet	2,7 m

Hot — temperature loss averaging 3°F/hour.

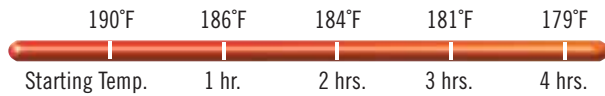

HOT HOLDING	150° to 165°F
WARM UP TIME (from ambient to temperature)	1 hour
RECOVERY TIME* (time to recover to temperature after door is held open for 30 seconds)	3 minutes
TRANSPORT TIME* (after reaching temperature, amount of time unit can be held passively/unplugged until contents reach 148°F.)	4 hours+

*Based on test with 4 full-sized, 4" deep H-Pans™ filled with 190°F hot water.

Capacity Guide

- UPCH400
- UPCH800 (x2)
- UPCH1600 (x4)

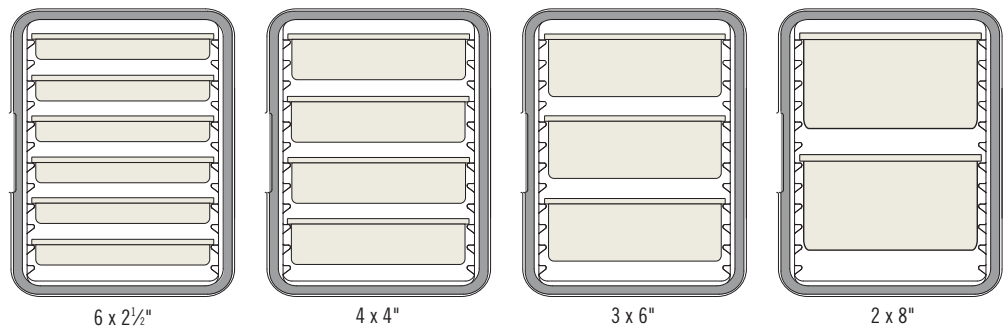

Food Pan Portion Guide

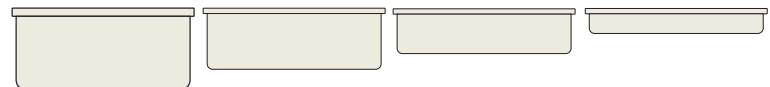

GN 1/3 Food Pan	8"	6"	4"	2 1/2"
Depth	8"	6"	4"	2 1/2"
Serving Portions Per Pan (1 cup)	80	60	40	30

Insulated Food Servers (Electric)

Ultra Pan Carrier® and Ultra Camcart® H-Series

Colors: Granite Gray (191), Granite Green (192), Slate Blue (401), Black (110), Dark Brown (131).



- Enables HACCP compliance by maintaining safe, hot food temperatures.
- UPCH400 models stack for storage or transporting on a Camdolly® with securing strap.



StoreSafe

Security Package

Tamper-resistant screws on latches. Non-removable doors. Casters and chassis plates mounted with tamper-resistant bolts. Locking hasp (optional item) for padlocks (not included).

CODE	DESCRIPTION	EXTERIOR DIMENSIONS W x D x H	COMPARTMENT DIMENSIONS W x D x H	CASE LB. (CUBE)	LIST PRICE EA.
1-Compartment Ultra Pan Carriers					
110V					
UPCH400	No casters	18 $\frac{1}{8}$ " x 26 $\frac{3}{8}$ " x 24 $\frac{7}{8}$ "	13 $\frac{1}{8}$ " x 21" x 19 $\frac{1}{8}$ "	45 (7.96)	\$ 1,330.00
UPCHW400	With casters	18 $\frac{1}{8}$ " x 27 $\frac{3}{8}$ " x 31 $\frac{1}{4}$ "	13 $\frac{1}{8}$ " x 21" x 19 $\frac{1}{8}$ "	54 (9.98)	1,525.00
220V					
UPCH4002	No casters	18 $\frac{1}{8}$ " x 26 $\frac{3}{8}$ " x 24 $\frac{7}{8}$ "	13 $\frac{1}{8}$ " x 21" x 19 $\frac{1}{8}$ "	45 (7.96)	1,330.00
UPCHW4002	With casters	18 $\frac{1}{8}$ " x 27 $\frac{3}{8}$ " x 31 $\frac{1}{4}$ "	13 $\frac{1}{8}$ " x 21" x 19 $\frac{1}{8}$ "	54 (9.98)	1,525.00
2-Compartment Ultra Camcarts					
110V					
UPCH800	Both doors heated	20 $\frac{1}{2}$ " x 27 $\frac{3}{8}$ " x 54"	13" x 21 $\frac{1}{2}$ " x 19 $\frac{1}{8}$ "	102 (19.89)	3,205.00
UPCHT800	Top door heated only	20 $\frac{1}{2}$ " x 27 $\frac{3}{8}$ " x 54"	13" x 21 $\frac{1}{2}$ " x 19 $\frac{1}{8}$ "	96 (19.89)	2,440.00
UPCH1600	Both doors heated	28 $\frac{3}{4}$ " x 33 $\frac{3}{8}$ " x 54 $\frac{1}{8}$ "	21" x 26 $\frac{1}{8}$ " x 21"	159 (35.33)	5,455.00
UPCH1600HD	Both doors heated, HD casters	28 $\frac{3}{4}$ " x 33 $\frac{3}{8}$ " x 54 $\frac{1}{2}$ "	21" x 26 $\frac{1}{8}$ " x 21"	168.5 (35.33)	5,610.00
UPCHT1600	Top door heated only	28 $\frac{3}{4}$ " x 33 $\frac{3}{8}$ " x 54 $\frac{1}{8}$ "	21" x 26 $\frac{1}{8}$ " x 21"	145 (35.33)	4,245.00
UPCHT1600HD	Top door heated only, HD casters	28 $\frac{3}{4}$ " x 33 $\frac{3}{8}$ " x 54 $\frac{1}{2}$ "	21" x 26 $\frac{1}{8}$ " x 21"	154.5 (35.33)	4,400.00
UPCHTR1600	Both door heated, Tamper Resistant	28 $\frac{3}{4}$ " x 33 $\frac{3}{8}$ " x 54 $\frac{1}{2}$ "	21" x 26 $\frac{1}{8}$ " x 21"	170 (35.33)	4,915.00
220V					
UPCH8002	Both doors heated	20 $\frac{1}{2}$ " x 27 $\frac{3}{8}$ " x 54"	13" x 21 $\frac{1}{2}$ " x 19 $\frac{1}{8}$ "	102 (19.89)	3,205.00
UPCHT8002	Top door heated only	20 $\frac{1}{2}$ " x 27 $\frac{3}{8}$ " x 54"	13" x 21 $\frac{1}{2}$ " x 19 $\frac{1}{8}$ "	96 (19.89)	2,440.00
UPCH16002	Both doors heated	28 $\frac{3}{4}$ " x 33 $\frac{3}{8}$ " x 54 $\frac{1}{8}$ "	21" x 26 $\frac{1}{8}$ " x 21"	159 (35.33)	5,455.00
UPCH16002HD	Both doors heated, HD casters	28 $\frac{3}{4}$ " x 33 $\frac{3}{8}$ " x 54 $\frac{1}{2}$ "	21" x 26 $\frac{1}{8}$ " x 21"	168.5 (35.33)	5,610.00
UPCHT16002	Top door heated only	28 $\frac{3}{4}$ " x 33 $\frac{3}{8}$ " x 54 $\frac{1}{8}$ "	21" x 26 $\frac{1}{8}$ " x 21"	145 (35.33)	4,245.00
UPCHT16002HD	Top door heated only, HD casters	28 $\frac{3}{4}$ " x 33 $\frac{3}{8}$ " x 54 $\frac{1}{2}$ "	21" x 26 $\frac{1}{8}$ " x 21"	154.5 (35.33)	4,400.00
UPCHTR16002	Both door heated, Tamper Resistant	28 $\frac{3}{4}$ " x 33 $\frac{3}{8}$ " x 54 $\frac{1}{2}$ "	21" x 26 $\frac{1}{8}$ " x 21"	170 (35.33)	4,915.00

Accessories for 1-Compartment

CD400, 400STP See Accessories Page 153

Also Available: Top and Bottom Replacement/Retrofit Doors for 110V and 220V (non-interchangeable).

UPCH Case Pack: 1

InStock Colors: Black (110), Dark Brown (131).

Standard Casters: 6" x 1 $\frac{1}{4}$ " – 2 fixed, 2 swivel, 1 with brake.

HD Casters: 6" x 2" – 2 fixed, 2 swivel with brake.



Insulated Food Servers (Electric)



Combo Cart™ Plus, Electric

- The most versatile insulated transporter on the market! Holds food pans, sheet pans, trays and even large pizza boxes.
- Two separate compartments offer the flexibility of holding either hot or cold food by simply keeping it unplugged.

- Tough, durable polyethylene exterior will not dent, rust or chip and remains cool to the touch during operation—a great alternative to metal holding carts!
- Thick, CFC-free polyurethane insulation throughout the cabinet ensures excellent food quality and temperature retention for 4 hours or more, even when unplugged.
- Over 50% more energy-efficient, on average, than leading metal carts.
- Ideal for caterers, schools, hotels and large institutions.

Color: Charcoal Gray (615).

Note: Place food pans on rails. Pans should not be placed on the floor of the compartment. All food should be cooled to 250°F before placing into cart to avoid damage to the body.



GASKET-FREE DOOR
Worry free door! Swings open completely to the side.

MARINE RAILING
Creates a bonus staging area for food pans.



STAINLESS STEEL UNIVERSAL RAILS
Holds sheet pans, food pans, pizza boxes and trays (or limitless combinations of these!)



ERGONOMIC VERTICAL MOLDED-IN HANDLES
Will never break; great for maneuvering by operators of all heights.

ENERGY-SAVING HEATER
Over 50% more energy efficient compared to leading metal carts! Gentle, non-radiant heat circulates consistently from front to back of the cabinet.

SOLAR DIGITAL THERMOMETER
Monitor internal cabinet temperature at a glance.

MENU POCKET
Allows for easy product ID with either an index card or by writing directly onto smooth surface with a grease pencil.

WIDE PADDLE LATCHES
For easy opening and closing.



POWER ON AND HEAT ON INDICATORS
Communicate the power and heating status of the unit. Know instantly when the compartment has reached target temperature. Turn on and off without unplugging the cord.

CASTERS
All swivel with brakes for smooth positioning and navigation; non-marking.

CORD KEEPER
Stores 9' (2,7 m) power cord neatly and safely.

PERIMETER BUMPER
Protects cart and walls.



INSULATION
CFC-free, polyurethane insulation throughout the body and doors maximizes heat or cold retention for 4 hours or more.

Insulated Food Servers (Electric)



Combo Cart™ Plus, Electric

CODE	DESCRIPTION	UNIT WEIGHT (LBS.)	CASE LBS. (CUBE)	LIST PRICE EA.
110V				
CMBPH	Standard Casters	232	252.5 (42.5)	\$ 7,775.00
CMBPHHD	Heavy Duty Casters	241.5	262 (42.5)	7,915.00
CMBPTH	Top Door Heated Only, Standard Casters	230.5	251 (42.5)	6,675.00
CMBPTHHD	Top Door Heated Only, Heavy Duty Casters	240	260.5 (42.5)	6,815.00
Security Package				
CMBPHSP	Standard Casters	233	253.5 (42.5)	8,295.00
CMBPHSPHD	Heavy Duty Casters	242.5	263 (42.5)	8,435.00
220V				
CMBPH2	Standard Casters	232	252.5 (42.5)	7,775.00
CMBPH2HD	Heavy Duty Casters	241.5	262 (42.5)	7,915.00
CMBPTH2	Top Door Heated Only, Standard Casters	230.5	251 (42.5)	6,675.00
CMBPTH2HD	Top Door Heated Only, Heavy Duty Casters	240	260.5 (42.5)	6,815.00

Standard Caster: 6" x 1½" (all swivel, with brakes) **Exterior Dimensions (W x D x H):** 27½" x 33½" x 65½"
Heavy Duty Caster: 6" x 2" (all swivel, with brakes) **Compartment Dimensions with column rails (W x D x H):** 21½" x 26¼" x 25½"
Case Pack: 1 **Color:** Charcoal Gray (615).

Security Package

Tamper-resistant screws on the latch handle assembly. Non-removable retainer rings on each hinge pin make doors non-removable. Built-in hasp for a transit seal or certain types of padlocks. Tamper-resistant fasteners for columns and cross-locking wires behind the columns lock the rails into place.



Optional Accessories

CODE	CMBPR1	CMBPR7
DESCRIPTION	1 Pair of Rails	7 Pair of Rails
CASE LBS. (CUBE)	4.12 (0.13)	27.75 (0.47)
LIST PRICE EACH	\$ 78.00	\$ 500.00

Case Pack: 1 **Color:** (000).

Electrical Specifications (Per Compartment)

	110V MODELS	220V MODELS
REQUIRED VOLTAGE	100-125 VAC	200-230 VAC
MAXIMUM AMP	4.6a	2.3a
WATTS	529w	506w
HERTZ	50/60	50/60
PHASE	Single	Single
PLUG TYPES	5-15 to C15RA	CEE7/7 to C15RA
ALTERNATE PLUG TYPES FOR INTERNATIONAL	JIS8303 to C15RA (Japan)	BS1363 to C15RA (UK / Ireland+more)
POWER CORD LENGTH	9 ft.	2,7 m

Holding Capacity Reference

TYPE OF CONTAINER	STANDARD CAPACITY	RAIL SPACING	MAXIMUM CAPACITY	RAIL SPACING
18" x 26" FULL SIZE SHEET PANS	14	3¾"	32*	1½"
13" x 18" FULL SIZE SHEET PANS	28	3¾"	64*	1½"
2½" DEEP HOTEL PANS	28	3¾"	28	3¾"
4" DEEP HOTEL PANS	20**	5"	20	5"
40 x 60 CM TRAYS	14	3¾"	32*	1½"
32,5 x 53 CM TRAYS	28	3¾"	52*	1½"
16" x 16" x 2" PIZZA BOXES	14	3¾"	22	2¼"

* Additional rails required.

** Only requires 5 pairs of rails.

Insulated Food Servers (Electric) — Camtherm® Electric Food Holding Cabinets



Go From Hot to Cold in One Versatile Appliance!

- Use for bulk food holding in the kitchen or to transport large amounts of food off-site.
- Go from hot to cold with the simple flip of a switch!
- Tough polyethylene exterior will not dent, rust or chip; stays cool to the touch during operation, unlike metal cabinets.
- Thick polyurethane foam insulation maintains safe food holding temperatures for 4 hours or more, even unplugged.
- Available in two sizes and hot only or hot/cold models.

Energy-efficient thermoelectric heating and cooling with:

No Compressor, heating coil or humidifier.

Low voltage, amps, wattage.



48%

**More
Energy
Efficient**

Than a Leading Metal Cabinet

Insulated Food Servers (Electric)



Camtherm® Electric Food Holding Cabinets

Assembly is covered by U.S. Patent D 442,756 S & D 6,344,630.

KNUCKLE DOOR HINGES

Withstand rigorous door openings, allows door to be lifted up and off for easy cleaning.

DOOR SWINGS OPEN 270°

for easy loading.

MARINE RAILING

Holds 2 full-sized food pans, 1 full-sized sheet pan or cutting board (CB1220).

SOLAR DIGITAL THERMOMETER

Monitor internal temperature at a glance.

SELF-VENTING CAP

Releases steam and equalizes pressure, maintaining food quality.

MENU CLIP

For easy product/event identification.

ADJUSTABLE CHROME-PLATED STEEL SLIDE RAILS

Hold full-size food pans or sheet pans.

POLYETHYLENE EXTERIOR

Stays cool to the touch during operation.

ERGONOMIC MOLDED-IN HANDLES

For easy maneuvering even when fully loaded.

ALUMINUM LOUVERS

Gently circulate hot or cold air evenly.

WIDE NYLON DOOR LATCHES/MAGNETIC DOOR GASKETS

Lock doors securely and create a tight seal to retain safe hot or cold food temperatures.

MOLDED-IN BUMPERS

Protect walls and furniture.

CONTROL PANEL (in back) On/Off switch

Temperature control dial for hot only models [Hot pre-set between 150° to 165°F (65° to 74°C)]. Hot/Cold switch for Hot/Cold Models only [Cold pre-set to 37°F (2,8°C)].

Camtherm® Electrical Specifications



ELECTRICAL SPECIFICATIONS

	LOW PROFILE HOT ONLY	LOW PROFILE HOT/COLD	TALL PROFILE HOT ONLY	TALL PROFILE HOT/COLD
VOLTS	110V	110V	110V	110V
PLUG TYPE	Nema 5-15P	Nema 5-15P	Nema 5-15P	Nema 5-15P
MAXIMUM AMP DRAW	9.1 amps	10.7 amps	14 amps	14.3 amps
AMPS RUN ON	9 amps	10.1 amps	13.8 amps	13.6 amps
WATTS	1035	1162	1587	1570
HERTZ	50/60	50/60	50/60	50/60
POWER INPUT OF HEATING UNIT	110-120 VAC	110-120 VAC	110-120 VAC	110-120 VAC

Insulated Food Servers (Electric)

Camtherm® Capacity Specifications

HOLDING CAPACITY	LOW PROFILE	HIGH PROFILE
Sheet Pans		
18" x 26" (45,7 x 66 cm)	11*	22**
Full-Size Food Pans		
2½" (6,5 cm) Deep	12	24
4" (10 cm) Deep	8	16
6" (15 cm) Deep	6	12
8" (20 cm) Deep	4	8

*Requires five additional rail sets **Requires five additional rail sets.

Security Package

Models are specifically modified with tamper-resistant hardware for operations where safety is a top priority.

- Security screws attach rail assembly to unit.
- Locking, stainless steel door latch—factory assembled.
- One-piece, welded rail and upright assembly available upon request.



Product Specifications CAD Drawings, Cut Sheets and User Manual Available at www.cambro.com.

	CODE	THERMOMETER	CASTERS	UNIT WEIGHT LBS	CASE LBS. (CUBE)	LIST PRICE EA.
	LOW PROFILE					
	EXTERIOR dimensions: W 30½" x D 42" x H 42¾"					
	<i>Hot Only</i>					
	CMBH1826LF	Fahrenheit	2 front 6" swivel w/brake, 2 rear 10" rigid	164	178 (32.85)	\$ 6,020.00
	CMBH1826LC	Celsius	2 front 6" swivel w/brake, 2 rear 10" rigid	164	178 (32.85)	6,020.00
	<i>Hot/Cold</i>					
	CMBHC1826LF	Fahrenheit	2 front 6" swivel w/brake, 2 rear 10" rigid	222	237 (32.85)	12,345.00
	CMBHC1826LC	Celsius	2 front 6" swivel w/brake, 2 rear 10" rigid	222	237 (32.85)	12,345.00
	LOW PROFILE WITH SECURITY PACKAGE					
	<i>Hot Only</i>					
CMBH1826LTR	Fahrenheit	2 front 6" swivel w/brake, 2 rear 10" rigid	167.39	181.39 (32.85)	6,305.00	
<i>Hot/Cold</i>						
CMBHC1826LTR	Fahrenheit	2 front 6" swivel w/brake, 2 rear 10" rigid	225.39	240.39 (32.85)	12,670.00	



TALL PROFILE

EXTERIOR dimensions: **W 30½" x D 39" x H 64¾"**

Hot Only

CMBH1826TSF	Fahrenheit	2 front 6" swivel w/brake, 2 rear 6" rigid	249.64	278.64 (47.5)	9,405.00
CMBH1826TBF	Fahrenheit	2 front 6" swivel w/brake, 2 rear 10" rigid	254	279.6 (47.57)	9,405.00
CMBH1826TSC	Celsius	2 front 6" swivel w/brake, 2 rear 6" rigid	249.64	278.64 (47.5)	9,405.00
CMBH1826TBC	Celsius	2 front 6" swivel w/brake, 2 rear 10" rigid	254	283 (47.5)	9,405.00

Hot/Cold

CMBHC1826TSF	Fahrenheit	2 front 6" swivel w/brake, 2 rear 6" rigid	325.5	354.5 (47.5)	17,340.00
CMBHC1826TBF	Fahrenheit	2 front 6" swivel w/brake, 2 rear 10" rigid	329.82	358.82 (47.5)	17,340.00
CMBHC1826TSC	Celsius	2 front 6" swivel w/brake, 2 rear 6" rigid	325.5	354.5 (47.5)	17,340.00
CMBHC1826TBC	Celsius	2 front 6" swivel w/brake, 2 rear 10" rigid	329.82	358.82 (47.5)	17,340.00

TALL PROFILE WITH SECURITY PACKAGE

Hot Only

CMBH1826TTR	Fahrenheit	2 front 6" swivel w/brake, 2 rear 10" rigid	260.77	289.77 (47.5)	9,925.00
-------------	------------	---	--------	---------------	----------

Hot/Cold

CMBHC1826TTR	Fahrenheit	2 front 6" swivel w/brake, 2 rear 10" rigid	336.59	365.59 (47.5)	17,895.00
--------------	------------	---	--------	---------------	-----------

Cabinet Colors: Granite Gray (191), Granite Green (192), Granite Sand (194).



CONFORMS TO UL
STD 197 & 471;
ANSI/NSF STD 4

ACCESSORIES	CODE	DESCRIPTION	DIMENSIONS L x W x H	CASE LBS. (CUBE)	CASE PACK	LIST PRICE EA.
	CMBR	Set of Slide Rails	20" x 4 ¹³ / ₁₆ "	2.25 (0.11)	1 set of 2 Rails	\$ 55.00
	CB1220	Cutting Board	21" x 13 ³ / ₈ " x ½"	4 (0.31)	1 each	42.00

Cutting Board Color: White (148). Venting plug is covered by US Patent D 553,717 S.

Transporter Capacity Guide

Loading Examples for Cambro® Insulated Transporters

TOP LOADERS

UPC140-UPC180
UPCS140-UPCS180
UPCSS160
125MPC

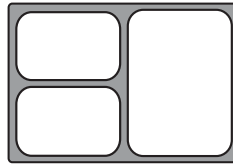
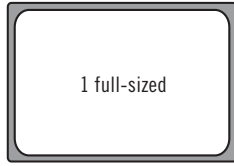

For a 3-course meal:
2 x GN ¼
1 x GN ½
1 DIV12 divider bar
(approx. 14 meals)

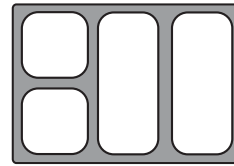

For a 4-course meal:
2 x GN ¼
2 x GN ½
2 DIV12 divider bars
(approx. 14 meals)

TOP LOADERS

100 series
100MPC
UPC100
UPC101

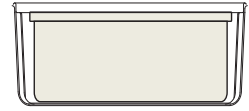
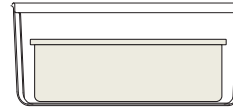
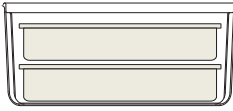
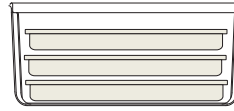

FRONT LOADERS

300MPC
UPC600 (x2)
UPC1200 (x4)

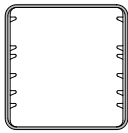

300MPC Rail Configuration

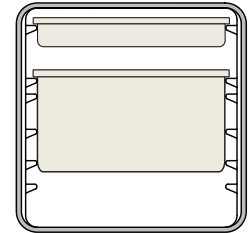
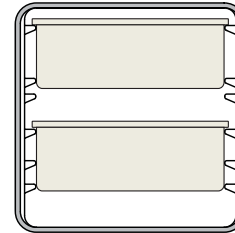
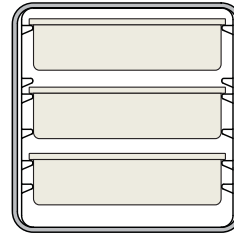
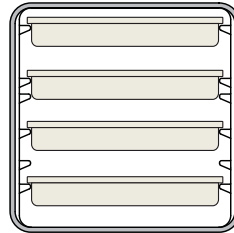

FRONT LOADERS

UPC400
UPCS400
UPCH400
UPC800 (x2)
UPCH800 (x2)
UPC1600 (x4)
UPCH1600 (x4)
CMB1826L (x2)

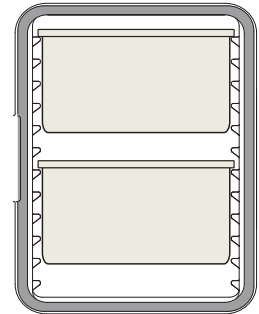
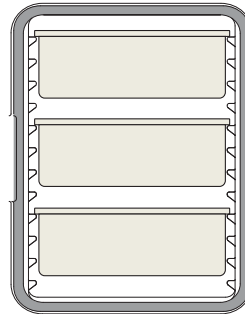
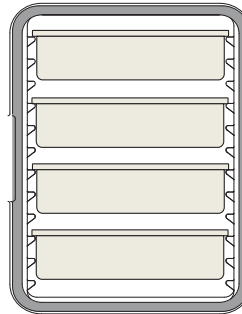
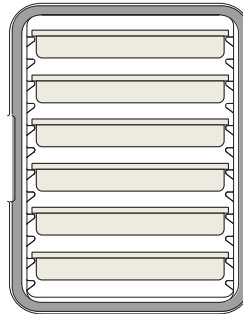

CAMCARRIERS® AND CAMCARTS® FOR SHEET PANS

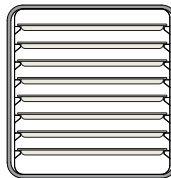

1318MTC
8 x ½ size
sheet pans



1826MTC
6 x full-size
sheet pans
1826DTC (x4)
CMB1826L (x2)

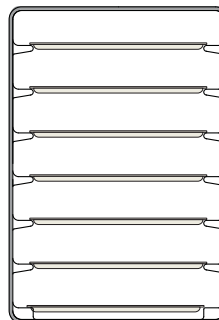

1826LTC3
7 x full-size
sheet pans

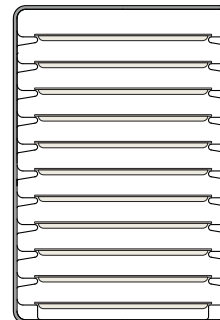

Camtherm Low
11 x full-size
sheet pans
Camtherm Tall (x2)

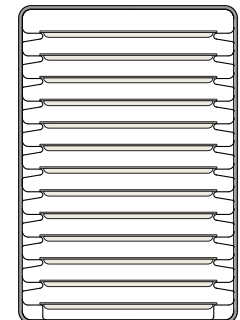

1826LTC
13 x full-size
sheet pans

SUMMARY OF GN CONTAINER SIZES

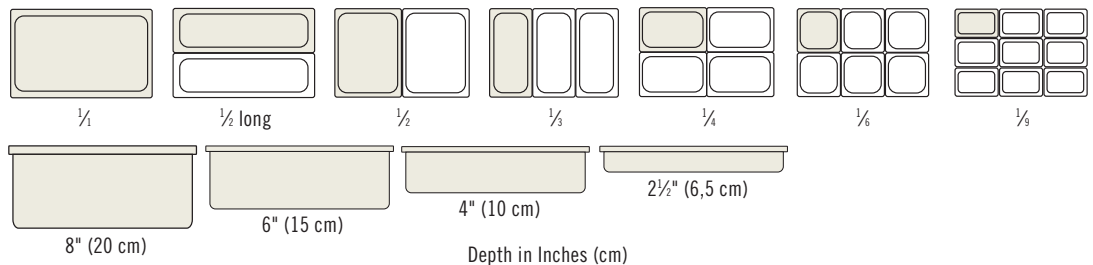



HEALTHCARE



Non-Skid Versa Camtrays®

- Non-Skid Trays reduce waste, save money and provide a stable tray surface for meal delivery.
- Switching from paper tray mats will generate annual savings of over 50%.
- Your Green Initiatives will get rapid results with the elimination of up to 10 tons of trash each year.
- Non-Skid Camtrays provide a better grip for safer meal delivery.
- Dishwasher safe in low and high temperatures.
- Stacking lugs allow for quick drying.

Camtray and Dietary Tray Colors:
Black with Pebbled Black (382),
Pearl Gray with Titan (381),
Ivory with Sahara (380).



Personalization available.
Visit www.cambro.com for details.



Versa Dietary Camtray



Non-skid trays grip table top items firmly.

CODE	DESCRIPTION	DIMENSIONS	CASE LBS. (CUBE)	LIST PRICE EA.
1418VC	Non-Skid Versa Camtray	14" x 18"	20.74 (0.69)	\$ 37.40
1520VC	Non-Skid Versa Camtray	15" x 20"	26.04 (0.4)	41.80
1622VC*	Non-Skid Versa Camtray	16" x 22"	32.16 (1.11)	51.70
1418VDC	Non-Skid Versa Dietary Tray	14" x 18"	20.45 (0.75)	37.40
1520VDC	Non-Skid Versa Dietary Tray	15" x 20"	26.88 (0.73)	41.80

Case Pack: 12 **InStock Colors:** Black with Pebbled Black (382),
Pearl Gray with Titan (381), Ivory with Sahara (380).
*1622VC only available in Ivory with Sahara (380).

Visit www.cambro.com/savemoney to see how much you can save by eliminating your purchase of paper mats.

Black with
Pebbled
Black (382)

Pearl Gray
with Titan
(381)

Non-Skid Versa Camtrays for Room Service

- Ergonomic handles allow for safe and elegant meal delivery.
- Trays fit within existing meal delivery carts that accommodate 15" x 20" trays.
- Non-skid surface eliminates the need for tray mats saving time and money.
- Dishwasher safe at high and low temperatures.
- Stacking lugs allow for quick drying.

Room Service Tray Colors:
Black with Pebbled Black (382),
Pearl Gray with Titan (381),
Ivory with Sahara (380).



Personalization available.
Visit www.cambro.com for details.



Ivory with
Sahara
(380)



CODE	DESCRIPTION	DIMENSIONS	CASE LBS. (CUBE)	LIST PRICE EA.
1520VCRST	Room Service Non-Skid Camtray	15" x 20"	22.5 (0.88)	\$ 44.00

Case Pack: 12 **InStock Colors:** Black with Pebbled Black (382), Pearl Gray with Titan (381), Ivory with Sahara (380).

Meal Delivery Ware System – The Shoreline Collection

A contemporary look, high performance, and unequalled safety at a budget-friendly price.

- Works with all Cambro Temperature Retention Bases and Pellets: Camduction® Complete Heat System, Camtherm® Thermal Pellet System, and the Heat Keeper Insulating Base System.

- The only NSF listed bowls and mug in the healthcare industry.
- Includes two types of Insulated Domes, three sizes of Insulated Bowls, one Insulated Mug, one Ceramic Plate and multiple heat and plate underliner options.

MDS9, MDSL9 and MDSPL9 not NSF Listed.

See Tray Section for full summary of size, shapes and colors.



Colors:



Meadow (447)



Wheat (457)



Cranberry (487)



Navy Blue (497)



Black (110)



Speckled Grey (480)

Meal Delivery Ware for Temperature Retention

Refer to Meal Delivery System page for colors

Camduction® Complete Heat System

Our most efficient heat retention solution, holds temperature for 60 or more minutes.



CODE	MDS09	MDSL09	MDSPL9	MDS0B9
DESCRIPTION	Insulated Dome covers 9" plate	Low Profile Insulated Dome cover 9" plate	Ceramic Plate	Camduction Base holds 9" plate
OUTSIDE DIAMETER	10¼"	10¼"	9"	9½"
OUTSIDE HEIGHT	3⅜"	2¾"	1"	1⅜"
FULL-SIZE CAMRACK®	PR59314	PR59314	PR314	CRP9911
CASE LBS. (CUBE)	10.92 (1.43)	9.78 (1.18)	38 (0.81)	32.52 (0.71)
CASE PACK	12	12	24	12
LIST PRICE EACH	\$ 18.55	\$ 14.00	\$ 189.00	\$ 95.00

MDSPL9 Color: Ivory (000). MDSPL9 Sold in full cases only, price per case. MDS0B9 for use with MDS0CB9. MDS0CB9 and MDS0DB9 are covered by U.S. Patent D 630, 8975.

Camtherm® Thermal Pellet System

The perfect choice for maximum heat retention, holds temperature for 60 or more minutes.



CODE	MDS09	MDSL09	MDSPL9	MDS09	MDSL9
DESCRIPTION	Insulated Dome covers 9" plate	Low Profile Insulated Dome covers 9" plate	Ceramic Plate	Thermal Pellet holds 9" plate	Pellet Underliner holds 9½" pellet
OUTSIDE DIAMETER	10¼"	10¼"	9"	9½"	9½"
OUTSIDE HEIGHT	3⅜"	2¾"	1"	1¼"	1⅝"
FULL-SIZE CAMRACK®	PR59314	PR59314	PR314	PR59314	PR59314
CASE LBS. (CUBE)	10.92 (1.43)	9.78 (1.18)	38 (0.81)	29.75 (0.64)	5.15 (0.46)
CASE PACK	12	12	24	12	12
LIST PRICE EACH	\$ 18.55	\$ 14.00	\$ 189.00	\$ 43.35	\$ 8.40

MDS09 Color: Dark Gray (477). MDS09 for use with CHPEL80.

MDSPL9 Color: Ivory (000). MDSPL9 Sold in full cases only, price per case. MDSL9 and MDS09 are NSF listed.

Heat Keeper Insulating Base System

The cost-effective solution for heat retention, holds temperature for 20 or more minutes.



CODE	MDS09	MDSL09	MDSPL9	HK39B
DESCRIPTION	Insulated Dome covers 9" plate	Low Profile Insulated Dome covers 9" plate	Ceramic Plate	Insulating Base holds 9" plate
OUTSIDE DIAMETER	10¼"	10¼"	9"	9⅝"
OUTSIDE HEIGHT	3⅜"	2¾"	1"	1⅝"
FULL-SIZE CAMRACK®	PR59314	PR59314	PR314	PR59314
CASE LBS. (CUBE)	10.92 (1.43)	9.78 (1.18)	38 (0.81)	9.25 (0.79)
CASE PACK	12	12	24	12
LIST PRICE EACH	\$ 18.55	\$ 14.00	\$ 189.00	\$ 10.65

MDSPL9 Color: Ivory (000). MDSPL9 Sold in full cases only, price per case. HK39B is NSF listed.

Camduction® Complete Heat System – The Heat Retention Solution

The new standard of meal delivery systems, the Camduction Complete Heat System is designed to perform consistently under the most demanding conditions of healthcare foodservice.

Camduction Charger Cart has NSF components.

MDSCDCB9 and MDSCDB9 are covered by U.S. Patent D 630, 8975S and 8,263,906 B2

Camduction Charger comes with 1 year warranty.



Heat up to 20 Camduction Bases at once.

A heated base is ready every 12 seconds.*

Camduction Cart is designed to hold and transport the Camduction Charger.

Adjustable shelves for proper height placement for any foodservice operator.

Unit exterior is cool to the touch.

Camduction Charger is made of high-grade, durable stainless steel.

Revolutionary technology eliminates errors or issues with spikes in voltage.

Food Temperature Retention*

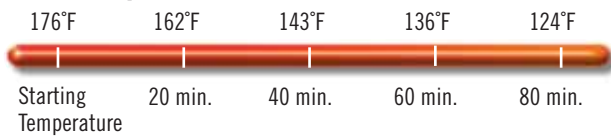

*Test performed with heated Cambro plate, dome, and Camduction Base.

Camduction Base

- Camduction Bases are durable and dishwasher safe.
- Resistant to chips, cracks, and breaks.
- Revolutionary technology eliminates errors or issues with spikes in voltage.
- 2 year pro-rated warranty on Bases.



CODE	MDSCDCB9
DESCRIPTION	Camduction Base Charger
NUMBER OF STACKS	2
CAPACITY	20 Bases
OVERALL DIMENSIONS W x D x H	30" x 18 $\frac{1}{8}$ " x 34 $\frac{1}{2}$ "
VOLTAGE/PHASE	208-240 (250 MAX) VAC, Single Phase
AMPS	24.9 (MAX)
HZ	50/60
PLUG CONFIGURATION	NEMA L6-30P
ELECTRICAL CORD	6 feet
HEAT UP TIME PER BASE/PELLET	12 seconds*
ALL INDICATOR LIGHTS	LED
PRODUCT WEIGHT	108.5 lbs.
CASE LBS (CUBE)	157 (17.38)
LIST PRICE EACH	\$ 8,500.00

Case Pack: 1

Color: Stainless Steel (000). *12 seconds at 220V.

Camtherm® Plate Heater and Pellet Heater



- Unmatched consistency and durability from the premier name in foodservice.
- Plate heater holds up to 100 plates and Pellet heater holds up to 80 pellets.
- Smart, dual-lid design conserves heat and energy by opening separately from each other.
- Stainless steel components ensure a rust-free environment.



Consistency



- Even, convection heating from top to bottom of each silo with two blowers and two heating elements.
- Self-leveling dispenser - plates and pellets dispense at the top of the opening, no matter if there are 2 plates or 50 plates.
- Plate retains safe-holding temperatures for at least 1 hour.*

Efficiency



- Insulated to keep plates or pellets hot while keeping the exterior cool to the touch.
- High-temperature silicone gasket and magnetic closers provide a locking seal that retains heat.
- Ergonomic, heavy-duty lid handles stay cool and offer a good grip.

Food Temperature Retention*

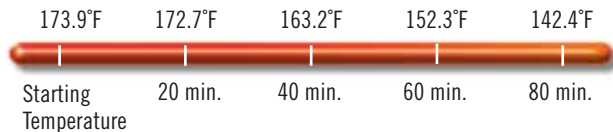

* Test performed with heated Cambro plate, pellet, underliner and dome.

CODE	CHPEL80	CHPL100
DESCRIPTION	Pellet Heater	Plate Heater
NUMBER OF STACKS	2	2
CAPACITY	80 pellets (40 in each stack)	100 plates (50 in each stack)
CASTER TYPE	Four 5" casters, two rigid and two swivel with brakes	Four 5" casters, two rigid and two swivel with brakes
OVERALL DIMENSIONS W x D x H	36½" x 25¼" x 46¼"	36½" x 25¼" x 46¼"
Electrical Specifications		
VOLTAGE/PHASE	208/240 VAC	208/240 VAC
AMPS	15	15
WATTS	3500	3500
HZ	50/60	50/60
ELECTRICAL CORD	6 Feet	6 Feet
NEMA PLUG CONFIGURATION	NEMA 6-15	NEMA 6-15
FACTORY SET TEMPERATURE	270 – 290°F	150 – 170°F
PRODUCT WEIGHT	248 lbs.	248 lbs.
CASE LBS (CUBE)	330 (37.40)	330 (37.40)
LIST PRICE EACH	\$ 9,500.00	\$ 9,500.00

Case Pack: 1
 Color: Stainless Steel (000).
 1.800.833.3003

Camtherm Thermal Pellet



- Holds heat at its core to keep hot foods at safe temperatures.
- Stays 20°F cooler on the edge than metal pellets to protect staff and patients from burns.
- Is a high-density plastic composite that won't dent like metal pellets.
- Holds a 9" plate.

Thermal Pellet Color: Dark Gray (477)



Meal Delivery Options and Accessories

Low Profile Dome Comparison

- Perfect for limited tray spacing as low as 4½".

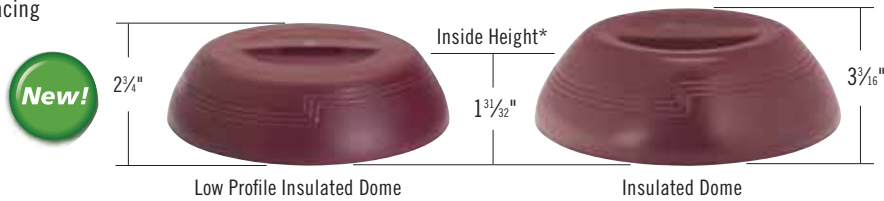

*This height is measured from a flat surface

Insulated Accessories



Mug features ergonomically-correct handle that fits three fingers.



CODE	MDSM8	MDSB5	MDSB9	MDSB16
DESCRIPTION	Mug	Sm. Bowl	Lg. Bowl	Entree Bowl
APPROX. CAPACITY TO RIM	8 oz.	5 oz.	9 oz.	16.9 oz.
OUTSIDE DIAMETER	3½" *	3½"	4⅜"	5⅜"
HEIGHT	4"	2⅝"	2⅝"	2⅝"
FULL-SIZE CAMRACK®	16C414	16C414	9S318	9S318
CASE LBS. (CUBE)	11.5 (1.55)	7.4 (0.94)	10.07 (1.4)	17 (2.29)
LIST PRICE EACH	\$ 3.00	\$ 3.00	\$ 3.00	\$ 5.85

Case Pack: 48 * MDSM8 Diameter 4½" with Handle. Refer to Meal Delivery System page for colors.

Reusable CamLids® for Meal Delivery Systems

- Save up to 75% in lid costs each year.
- Reduce your waste-stream by ten tons each year when you switch from disposables to reusables.*
- Dishwasher safe.

*Based on 100 bed facility using 3 disposable lids for 3 meals daily.



Camrack® Wash and Store Rack

Specifically designed for safely and securely washing and storing Reusable CamLids. Each Camrack Wash and Store Rack holds 36 Reusable CamLids.



Wash and Store Racks in Full Size Base Rack.

Reusable Lids Colors: Speckled White (490), Midnight Blue (453).

Camrack Wash and Store Rack Color: Kelly Green (452).

Camrack Base Full Size InStock Color: Soft Gray (151).

Full Rack Cover InStock Color: Gray (180).

CLRWSR36 is covered under U.S. patent D 617,069.

Full Rack Cover not NSF certified.



Visit www.cambro.com/savemoney for a Customized Savings Calculator!

CODE	DESCRIPTION	DIMENSIONS	CASE LBS. (CUBE)	CASE PACK	LIST PRICE EA.
Reusable CamLids		H x DIA.			
CLRSM8B5	Fits Shoreline 8 oz. mug and 5 oz. bowl	¾" x 3⅜"	4.54 (0.38)	240	\$ 119.00
CLRSB9	Fits Shoreline 9 oz. bowl	¾" x 4⅜"	6.69 (0.59)	240	158.50
CLRSB16	Fits Shoreline 16 oz. bowl	¾" x 5⅜"	9.6 (1.41)	240	260.00
Accessories for CLRSM8B5 and CLRSB9		L x W x H			
CLRWSR36	Camrack Wash and Store Rack for Reusable Lids	8¼" x 17⅞" x 5½"	4.2 (1.27)	4	24.90
BR578	Camrack Full Size Base Rack with 2 extenders	19¾" x 19¾" x 7¼"	24.66 (6.76)	4	62.90
DRC2020	Full Rack Cover	19⅝" x 19⅝" x 1⅝"	2.3 (0.34)	1	55.55
Accessories for CLRSB16		L x W x H			
PR500	9 x 9 Peg Rack with 1 Extender	19¾" x 19¾" x 5⅞"	29.28 (6.93)	5	51.60
E3	Full Size Open Extender	19¾" x 19¾" x 2"	16.90 (5.52)	12	12.45
CRPHDG2878	Full Size Square Hold Down Grid	18⅝" x 18⅝"	11.05 (0.49)	6	25.85

Reusable CamLids sold in cases only. No broken cartons.



Disposable CamLids®

Disposable Lids for Shoreline



LID CODE	CLSM8B5	CLS9	CLSB16	CLSSM8B5
DESCRIPTION	Sm. Disp. Lid	Lg. Disp. Lid	Disp. Entree Bowl Lid	Disp. Sip. Lid
FITS	MDSB5, MDSM8	MDSB9	MDSB16	MDSB5, MDSM8
OUTSIDE DIAMETER	3 ⁹ / ₁₆ "	4 ⁷ / ₁₆ "	5 ¹ / ₂ "	3 ⁹ / ₁₆ "
HEIGHT	5 ¹ / ₁₆ "	5 ¹ / ₁₆ "	5 ¹ / ₁₆ "	1 ¹ / ₁₆ "
CASE LBS. (CUBE)	9 (1.9)	10 (2.26)	13 (2.49)	7 (1.39)
CASE PACK	1,500	1,000	1,000	1,000
LIST PRICE PER CASE	\$ 97.65	\$ 81.90	\$ 110.00	\$ 81.90

CLSM8B5, CLS9 and CLSB16 Color: Translucent (190). CLSSM8B5 Color: White (148).
Sold in full cases only. No broken cartons.

Disposable Lids for Newport Tumblers



LID CODE	CLNT5	CLNT8	CLNT10	CLNT12
FITS TUMBLER	NT5	NT8	NT10	NT12
TUMBLER CAPACITY	6.4 oz.	8 oz.	10 oz.	12.6 oz.
CASE LBS. (CUBE)	6 (1.07)	5 (0.85)	5 (1.0)	5 (0.98)
CASE PACK	1,500	1,000	1,000	1,000
LIST PRICE PER CASE	\$ 110.25	\$ 69.60	\$ 89.25	\$ 97.75

Color: Translucent (190). Sold in full cases only. No broken cartons.

Disposable Lids for Laguna® Tumblers



LID CODE	CLLT6	CLLT10	CLLT12
FITS TUMBLER	LT6	LT10	LT12
TUMBLER CAPACITY	6 oz.	10 oz.	12 oz.
CASE LBS. (CUBE)	6 (1.07)	5 (0.98)	6 (1.09)
CASE PACK	1,500	1,000	1,000
LIST PRICE PER CASE	\$ 110.25	\$ 89.25	\$ 97.75

Color: Translucent (190). Sold in full cases only. No broken cartons.

Disposable Lids for Colorware Tumblers



LID CODE	CL900P	CL950P
FITS TUMBLERS	900P / 900P2	950P / 950P2
TUMBLER CAPACITY	9.7 oz.	9.8 oz.
CASE LBS. (CUBE)	6 (1.05)	6 (0.85)
CASE PACK	1,000	1,000
LIST PRICE PER CASE	\$ 97.75	\$ 71.30

Color: Translucent (190). Sold in full cases only. No broken cartons.

Disposable Lid for Swirl Bowls



LID CODE	CLSRB5
FITS SWIRL BOWLS	SRB5CW / SRB5
SWIRL BOWL CAPACITY	5 oz.
CASE LBS. (CUBE)	10 (2.23)
CASE PACK	1,000
LIST PRICE PER CASE	\$ 146.45

Color: Clear (152). Sold in full cases only. No broken cartons.

Camduction® Cart for Charger



Camduction Charger Cart has NSF components.

Camtherm® Thermal Pellet Lifter



Safely lift hot, thermal pellets or plates with the Cambro Pellet Lifter.

CODE	MDSDCCPKG480*
DESCRIPTION	Camduction Cart for Charger
DIMENSIONS L x W x H	36" x 24" x 35"
CASE LBS. (CUBE)	54.8 (2.32)
CASE PACK	1
LIST PRICE EACH	\$ 560.00

Color: Speckled Gray (480).
* Ships in 7 separate cartons.

CODE	MDSPL
DESCRIPTION	Pellet Lifter
OUTSIDE DIAMETER	3 3/8"
HEIGHT	3"
CASE LBS. (CUBE)	0.4 (0.03)
CASE PACK	1
LIST PRICE EACH	\$ 81.90

MDSPL Color: (000).

Camshelving® Drying and Storage Cart



- Keeps trayline and dishwashing areas organized and efficient.
- Cradles are made of stainless steel.
- Shelving posts and traverses feature a steel core with a smooth polypropylene exterior.
- Cradles are removable and fit into a Camrack® base rack (BR258) for dishwasher service.
- Dome Drying Rack holds 100 each 10" domes and/or pellet underliners.
- Camduction Base Drying Rack holds 180 each Camduction Bases, and/or Camtherm Thermal Pellets.

Color:
Cart - Speckled Gray (480)
Cradle - Stainless Steel (000).



MDSDCPKG480

CSDDCPKG480

CODE	DESCRIPTION	DIMENSIONS L x W x H	CASE LBS. (CUBE)	LIST PRICE EA.
CSDDCPKG480*	Dome Drying and Storage Cart	36" x 18" x 75"	114.0 (10.23)	\$ 2,166.40
MDSDCPKG480**	Camduction Base and Thermal Pellet Drying and Storage Cart	48" x 18" x 75"	143.51 (16.14)	3,100.00
CSDC	Dome Drying Cradle	17 3/4" x 16" x 10"	4.5 (1.11)	136.00
CSPDC5	Camduction Base and Thermal Pellet Drying Cradle	17 3/16" x 13 3/4" x 10"	17.77 (2.51)	758.00

Case Pack: 1

*Ships in 3 cartons, Carton 1: 2 Post Kits, 10 Traverses and 4 Casters, Carton 2: Set of 5 Drying Cradles, Carton 3: Set of 5 Drying Cradles.

**Ships in 7 cartons.

Meal Delivery Carts for Tray Service (20 Tray Capacity)



- Use to transport meal trays from the kitchen to acute care patients, nursing home residents or correctional facility inmates.
- Ensures optimal food quality and short delivery times.
- Tough, one-piece, non insulated double-wall polyethylene carts are easy to clean and won't rust, dent, crack, chip or break.
- All units have light-weight non-insulated ABS doors.

MDC1520T16 and MDC1418T16 are covered by U.S. Patent D 398,727.



Marine rail is designed for use during service, not transport.



Low Profile

CODE	MDC1520S20	MDC1418S20
TRAY SIZE	15" x 20"	14" x 18"
TRAYS PER CART / PER COMPARTMENT	20 / 10	20 / 10
RAILS PER COMPARTMENT	5	5
TRAYS PER RAIL / RAIL SPACING	2 / 5½"	2 / 5½"
NUMBER OF COMPARTMENTS	2	2
NUMBER OF MENU CLIPS	2	2
MENU CLIPS - LOCATION	1 per door	1 per door
HANDLES - TYPE AND LOCATION	Molded in, each end	Molded in, each end
CASTER TYPE	5", 2 end swivel w/brake; 8", 2 rigid wheel on center axle	5", 2 swivel w/brake, 2 rigid, offset
LATCHES	2 internal nylon friction	2 internal nylon friction
EXTERNAL DIMENSIONS W x D x H	55½" x 38" x 43¼"	48½" x 32½" x 44"
INTERNAL DIMENSIONS W x D x H	20½" x 30¼" x 27½"	18½" x 28½" x 29"
REQUIRED DOOR WIDTH	38½"	33"
UNIT WEIGHT LBS	144.2 lbs.	138.4 lbs.
CASE LBS. (CUBE)	165.2 (55.72)	160.4 (41.54)
LIST PRICE EACH	\$ 3,610.00	\$ 3,545.00

Case Pack: 1 Colors (All carts with cream color doors): Gray (180), Slate Blue (401), Granite Gray (191), Granite Green (192), Granite Sand (194).

Meal Delivery Carts for Tray Service (16 & 30 Tray Capacity)



Marine rail is designed for use during service, not transport.



Tall Profile

CODE	MDC1520T30	MDC1418T30	MDC1520T16	MDC1418T16
TRAY SIZE	15" x 20"	14" x 18"	15" x 20"	14" x 18"
TRAYS PER CART / COMPARTMENT	30 / 10	30 / 10	16 / 8	16 / 8
RAILS PER COMPARTMENT	10	10	4	4
TRAYS PER RAIL / RAIL SPACING	1 / 5"	1 / 5"	2 / 5/4"	2 / 5/4"
NUMBER OF COMPARTMENTS	3	3	2	2
NUMBER OF MENU CLIPS	5	5	1	1
MENU CLIPS - LOCATION	Each door, each end	Each door, each end	Back of cart only	Back of cart only
HANDLES - TYPE AND LOCATION	Heavy-duty nylon, mounted 1 per end	Heavy-duty nylon, mounted 1 per end	Molded-in, back of cart	Molded-in, back of cart
CASTER TYPE	6", 2 rigid, 4 swivel with brake, offset	6", 2 rigid, 4 swivel with brake, offset	6", 2 rigid, 2 swivel with brake	6", 2 rigid, 2 swivel with brake
LATCHES	Friction catch, Transit latches*	Friction catch, Transit latches*	Large paddle latch	Large paddle latch
EXTERNAL DIMENSIONS W x D x H	60" x 29 1/4" x 63 5/8"	60" x 29 1/4" x 63 5/8"	30 5/8" x 39 1/8" x 58 1/8"	28" x 36 1/2" x 58 1/8"
INTERNAL DIMENSIONS W x D x H	15 1/4" x 21" x 50"	14 1/2" x 21 1/2" x 50"	20 5/8" x 30 1/2" x 21 1/2"	18 3/8" x 29 3/8" x 21 1/2"
REQUIRED DOOR WIDTH	30"	30"	31"	28 1/2"
UNIT WEIGHT LBS.	208.4 lbs.	231.86 lbs.	134.2 lbs.	138.9 lbs.
CASE LBS. (CUBE)	234 (70.67)	282.1 (65.59)	157.7 (45.88)	140.67 (39.46)
LIST PRICE EACH	\$ 5,790.00	\$ 5,735.00	\$ 3,330.00	\$ 3,245.00

Case Pack: 1 Cart Colors (All carts with cream color doors): Gray (180), Slate Blue (401), Granite Gray (191), Granite Green (192), Granite Sand (194). *Stainless steel transit latch at top of each door. For lighter-duty applications, 30-tray carts may be ordered without the steel transit latches by using product code MDC1520T30NL or MDC1418T30NL.

Meal Delivery Carts Features and Caster Configurations

Standard Caster Configurations

MDC1520S20

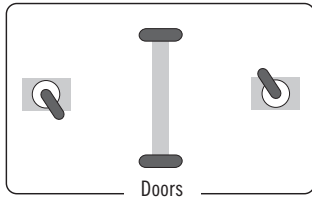

Diamond pattern with axle configuration allows the cart to turn on its own center.

MDC1418S20, MDC1411T60

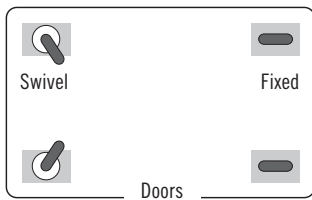

This configuration offers lead in casters to increase stability and maneuverability over uneven surfaces.

MDC1520T16, MDC1418T16

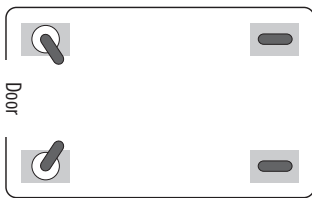

This configuration offers stability and makes the cart easy to maneuver.

MDC1520T30, MDC1418T30

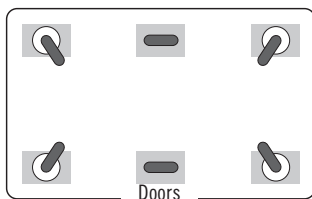

This configuration offers lead in casters to increase stability over uneven surfaces while providing a tighter turning radius.

LEAD IN CASTERS



Castors are offset to ease movement over uneven surfaces. This is standard on MDC1418S20, MDC1520T30, MDC1418T30 and MDC1411T60.

Optional Caster Configurations for Models:

MDC1418S20, MDC1520T30, MDC1418T30 and MDC1411T60

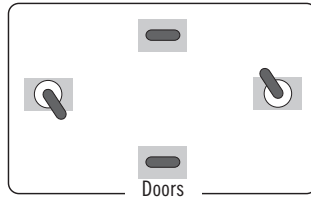

Diamond pattern configuration offers lead in casters and makes the cart highly maneuverable while providing a tighter turning radius.

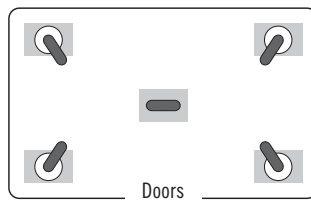

The 5-caster configuration offers lead in casters to ease movement over uneven surfaces while reinforcing linear motion.

Handles

MDC1520S20, MDC1418S20



Molded in handles on each end for smooth transporting.

MDC1520T16, MDC1418T16



Molded in handles for easy transporting.

MDC1520T30, MDC1418T30, MDC1411T60*



Heavy duty nylon handles are securely mounted and nested into each end. *MDC1411T60 has tamper resistant heavy duty aluminum tubing handles.

Meal Delivery Cart For Correctional Tray Service

Modified for use in correctional facilities. Holds 60 each 1411CW or 1411CP Cambro Base Trays with 853 Insert Trays or 60 each 10146DCW or 10146DCP Separator Compartment Trays. Security features include security screws on handles, stop locks on door knuckles, security bolts for transit latches and caster carriage bolts with lock nuts.



CODE	MDC1411T60
TRAY SIZE	14" x 11" Base Tray 1411CW and 1411CP
TRAYS PER CART / PER COMPARTMENT	60 / 20
RAILS PER COMPARTMENT	10
TRAYS PER RAIL / RAIL SPACING	2 / 5"
NUMBER OF COMPARTMENTS	3
MENU CLIPS	None
HANDLES - TYPE AND LOCATION	Heavy-duty aluminum with security screws, black finish, 1 per end
CASTER TYPE	6" heavy-duty casters, 2" wide tread, 2 swivel no brake, 2 rigid
LATCHES	Internal friction catch, 2 per door, transit latch**
EXTERNAL DIMENSIONS W x D x H	60" x 29 ¹ / ₄ " x 63 ⁵ / ₈ "
INTERNAL DIMENSIONS W x D x H	14 ¹ / ₂ " x 21 ¹ / ₂ " x 50"
REQUIRED DOOR WIDTH	30"
UNIT WEIGHT LBS.	228 lbs.
CASE LBS. (CUBE)	278 (65.59)
LIST PRICE EACH	\$ 5,735.00

Case Pack: 1 Colors: Granite Gray (191), Granite Sand (194), Slate Blue (401).

**Stainless steel transit latch at top of each door.



WAREWASHING & STORAGE SYSTEM

Camrack® 4-in-1 Warewashing System

The Camrack System will protect glassware and keep it clean until the next event, eliminating the need for rewashing.

Efficient Washing

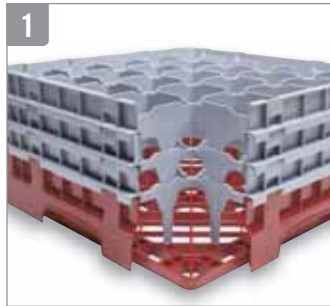

Open inside compartments provide thorough circulation of water and cleaning solutions and promote quick and thorough drying. Long-lasting polypropylene Camracks are built to withstand chemicals and high temperatures up to 200°F (93°C).

Sanitary Storage



Closed outer walls keep fingers and contaminants out and reduce risk of breakage and injury. The Camrack cover and Camdolly make this system completely enclosed. Glassware stays clean when in storage, so operators will only have to wash items once.

Inventory Control



A variety in base rack colors help identify at a glance both contents and quantity per rack. Available in 10 colors.

Safe, Sanitary Transportation



Camracks can be transported across large campuses or to off-site locations in one single unit. Easy to grip handles and smooth overlapping sides facilitate safe handling.

Camrack Cover Seals from the Top and Camdolly® Seals from the Bottom



Camracks interstack with racks from major manufacturers.

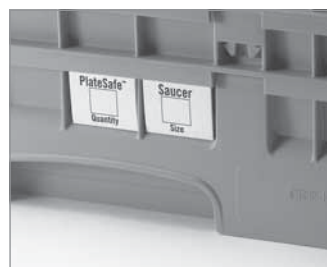

Content labeling options include one-color custom hot stamping or pre-printed clips that are added at factory during assembly.



Camracks are covered by one or more of the following patents: Full Base Dish Rack D 412,607. Half Base Dish Rack D 404,176. Half Dish Rack Extender D 400,321. Enlarged Dish Rack Extender D 399,614. Dish Rack with Extender 5,934,486 Utility Patent. Pronged Base Dish Rack D 403,472.

Full Size Camracks® for Stemware & Tumblers

These racks offer complete protection for all your delicate and valuable stemware and tumblers, from washing and handling to stacking, storing and transporting.

Choose the correct dishrack:

1. Measure the maximum diameter of your glass (stemware or tumbler) to determine the number of compartments.
2. Measure the maximum height of your glass (stemware or tumbler) to the top edge of the rim to determine the compartment height.

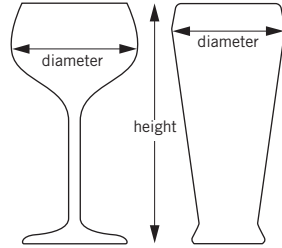

25S534

Camrack Sizing Guides are available at www.cambro.com under Resource Center.

9 COMPARTMENT

<p>5 7/8" 14,8 cm MAXIMUM DIAMETER</p>	MAXIMUM HEIGHT	3 5/8" 9 cm	5 1/4" 13,2 cm	6 7/8" 17,4 cm	8 1/2" 21,6 cm	10 1/8" 25,8 cm	11 3/4" 30 cm
	CODE	9S318	9S434	9S638	9S800	9S958	9S1114
	CASE PACK	5	4	3	2	2	2
	CASE LBS. (CUBE)	28.03 (6.93)	29.26 (6.93)	27.27 (6.38)	22.02 (4.86)	25.10 (5.96)	28.58 (6.93)
	CASE KG (CUBE M³)	12,71 (0,196)	13,27 (0,196)	12,37 (0,181)	9,98 (0,138)	11,39 (0,169)	12,96 (0,196)
	RACK DIMENSION	19 1/4" x 19 1/4" x 5 1/2" 50 x 50 x 14,3 cm	19 1/4" x 19 1/4" x 7 1/4" 50 x 50 x 18,4 cm	19 1/4" x 19 1/4" x 8 1/8" 50 x 50 x 22,5 cm	19 1/4" x 19 1/4" x 10 1/2" 50 x 50 x 26,7 cm	19 1/4" x 19 1/4" x 12 1/8" 50 x 50 x 30,8 cm	19 1/4" x 19 1/4" x 13 3/4" 50 x 50 x 34,9 cm
	LIST PRICE EACH	\$ 51.60	\$ 67.30	\$ 80.35	\$ 97.70	\$ 113.25	\$ 131.90

16 COMPARTMENT

<p>4 3/8" 10,9 cm MAXIMUM DIAMETER</p>	MAXIMUM HEIGHT	3 5/8" 9 cm	4 1/2" 11 cm	5 1/4" 13,2 cm	6 1/8" 15,2 cm	6 7/8" 17,4 cm	7 3/4" 19,4 cm
	CODE	16S318	16S418**	16S434	16S534**	16S638	16S738**
	CASE PACK	5	5	4	4	3	3
	CASE LBS. (CUBE)	27.18 (6.93)	28.63 (6.93)	28.62 (6.93)	29.82 (6.93)	26.82 (6.38)	27.72 (6.38)
	CASE KG (CUBE M³)	12,33 (0,196)	12,99 (0,196)	12,98 (0,196)	13,52 (0,196)	12,17(0,181)	12,57 (0,181)
	RACK DIMENSION	19 1/4" x 19 1/4" x 5 1/2" 50 x 50 x 14,3 cm	19 1/4" x 19 1/4" x 5 1/2" 50 x 50 x 14,3 cm	19 1/4" x 19 1/4" x 7 1/4" 50 x 50 x 18,4 cm	19 1/4" x 19 1/4" x 7 1/4" 50 x 50 x 18,4 cm	19 1/4" x 19 1/4" x 8 1/8" 50 x 50 x 22,5 cm	19 1/4" x 19 1/4" x 8 1/8" 50 x 50 x 22,5 cm
	LIST PRICE EACH	\$ 51.60	\$ 54.05	\$ 67.65	\$ 69.25	\$ 81.20	\$ 82.90
MAXIMUM HEIGHT	8 1/2" 21,6 cm	9 3/8" 23,8 cm	10 1/8" 25,8 cm	11" 27,8 cm	11 3/4" 30 cm	12 5/8" 32 cm	
CODE	16S800	16S900**	16S958	16S1058**	16S1114	16S1214**	
CASE PACK	2	2	2	2	2	2	
CASE LBS. (CUBE)	21.74 (4.86)	22.34 (4.86)	24.84 (5.96)	25.44 (5.96)	28.34 (6.93)	28.94 (6.93)	
CASE KG (CUBE M³)	9,86 (0,138)	10,13 (0,138)	11,27 (0,169)	11,54 (0,169)	12,86 (0,196)	13,13 (0,196)	
RACK DIMENSION	19 1/4" x 19 1/4" x 10 1/2" 50 x 50 x 26,7 cm	19 1/4" x 19 1/4" x 10 1/2" 50 x 50 x 26,7 cm	19 1/4" x 19 1/4" x 12 1/8" 50 x 50 x 30,8 cm	19 1/4" x 19 1/4" x 12 1/8" 50 x 50 x 30,8 cm	19 1/4" x 19 1/4" x 13 3/4" 50 x 50 x 34,9 cm	19 1/4" x 19 1/4" x 13 3/4" 50 x 50 x 34,9 cm	
LIST PRICE EACH	\$ 98.00	\$ 99.75	\$ 113.25	\$ 115.00	\$ 131.90	\$ 133.50	



Base Rack Colors:





InStock Color: Soft Gray (151). **Extender Color:** Soft Gray (151). ** Compartment Extenders cannot be added. Personalization available. See Camrack personalization and color coding page. Contact Customer Service for all special orders.

Full Size Camracks® for Stemware & Tumblers

20 COMPARTMENT



 <p>3 7/8" 9.84 cm MAXIMUM DIAMETER</p>	MAXIMUM HEIGHT 	3 5/8" 9 cm	5 1/4" 13.2 cm	6 7/8" 17.4 cm	8 1/2" 21.6 cm	10 1/8" 25.8 cm	11 3/4" 30 cm
	CODE	20S318	20S434	20S638	20S800	20S958	20S1114
	CASE PACK	5	4	3	2	2	2
	CASE LBS. (CUBE)	28.10 (6.93)	29.84 (6.93)	28.9 (6.38)	22.91 (4.86)	26.17 (5.96)	29.91 (6.93)
	CASE KG (CUBE M³)	12.77 (0,196)	13,56 (0,196)	12,77 (0,181)	10,41 (0,138)	11,89 (0,169)	13,59 (0,196)
	RACK DIMENSION	19 3/4" x 19 3/4" x 5 5/8" 50 x 50 x 14,3 cm	19 3/4" x 19 3/4" x 7 1/4" 50 x 50 x 18,4 cm	19 3/4" x 19 3/4" x 8 7/8" 50 x 50 x 22,5 cm	19 3/4" x 19 3/4" x 10 1/2" 50 x 50 x 26,7 cm	19 3/4" x 19 3/4" x 12 5/8" 50 x 50 x 30,8 cm	19 3/4" x 19 3/4" x 13 3/4" 50 x 50 x 34,9 cm
	LIST PRICE EACH	\$ 51.60	\$ 68.50	\$ 81.95	\$ 98.00	\$ 113.25	\$ 131.90

25 COMPARTMENT

 <p>3 4/9" 8.7 cm MAXIMUM DIAMETER</p>	MAXIMUM HEIGHT 	3 5/8" 9 cm	4 1/2" 11 cm	5 1/4" 13.2 cm	6 1/8" 15.2 cm	6 7/8" 17.4 cm	7 3/4" 19.4 cm
	CODE	25S318	25S418**	25S434	25S534**	25S638	25S738**
	CASE PACK	5	5	4	4	3	3
	CASE LBS. (CUBE)	28.08 (6.93)	30.13 (6.93)	29.78 (6.93)	31.50 (6.93)	28.02 (6.38)	29.31 (6.38)
	CASE KG (CUBE M³)	12,74 (0,196)	13,67 (0,196)	13,51 (0,196)	14,29 (0,196)	12,71 (0,181)	13,30 (0,181)
	RACK DIMENSION	19 3/4" x 19 3/4" x 5 5/8" 50 x 50 x 14,3 cm	19 3/4" x 19 3/4" x 5 5/8" 50 x 50 x 14,3 cm	19 3/4" x 19 3/4" x 7 1/4" 50 x 50 x 18,4 cm	19 3/4" x 19 3/4" x 7 1/4" 50 x 50 x 18,4 cm	19 3/4" x 19 3/4" x 8 7/8" 50 x 50 x 22,5 cm	19 3/4" x 19 3/4" x 8 7/8" 50 x 50 x 22,5 cm
	LIST PRICE EACH	\$ 51.60	\$ 55.85	\$ 68.50	\$ 71.85	\$ 81.95	\$ 88.65
	MAXIMUM HEIGHT 	8 1/2" 21,6 cm	9 3/8" 23,8 cm	10 1/8" 25,8 cm	11" 27,8 cm	11 3/4" 30 cm	12 5/8" 32 cm
	CODE	25S800	25S900**	25S958	25S1058**	25S1114	25S1214**
	CASE PACK	2	2	2	2	2	2
CASE LBS. (CUBE)	22.76 (4.86)	23.62 (4.86)	26.08 (5.96)	26.94 (5.96)	29.80 (6.93)	30.66 (6.93)	
CASE KG (CUBE M³)	10,32 (0,138)	10,71 (0,138)	11,83 (0,169)	12,22 (0,169)	13,52 (0,196)	13,91 (0,196)	
RACK DIMENSION	19 3/4" x 19 3/4" x 10 1/2" 50 x 50 x 26,7 cm	19 3/4" x 19 3/4" x 10 1/2" 50 x 50 x 26,7 cm	19 3/4" x 19 3/4" x 12 5/8" 50 x 50 x 30,8 cm	19 3/4" x 19 3/4" x 12 5/8" 50 x 50 x 30,8 cm	19 3/4" x 19 3/4" x 13 3/4" 50 x 50 x 34,9 cm	19 3/4" x 19 3/4" x 13 3/4" 50 x 50 x 34,9 cm	
LIST PRICE EACH	\$ 98.00	\$ 106.50	\$ 113.25	\$ 123.35	\$ 131.90	\$ 141.95	

** Compartment Extenders cannot be added.

30 COMPARTMENT

 <p>3 3/8" 7.94 cm MAXIMUM DIAMETER</p>	MAXIMUM HEIGHT 	3 5/8" 9 cm	5 1/4" 13.2 cm	6 7/8" 17.4 cm	8 1/2" 21.6 cm	10 1/8" 25.8 cm	11 3/4" 30 cm
	CODE	30S318	30S434	30S638	30S800	30S958	30S1114
	CASE PACK	5	4	3	2	2	2
	CASE LBS. (CUBE)	29.21 (6.93)	31.33 (6.93)	29.66 (6.38)	24.25 (4.86)	27.8 (5.96)	31.85 (6.93)
	CASE KG (CUBE M³)	13,28 (0,196)	14,24 (0,196)	13,48 (0,181)	11,02 (0,138)	12,64 (0,169)	14,48 (0,196)
	RACK DIMENSION	19 3/4" x 19 3/4" x 5 5/8" 50 x 50 x 14,3 cm	19 3/4" x 19 3/4" x 7 1/4" 50 x 50 x 18,4 cm	19 3/4" x 19 3/4" x 8 7/8" 50 x 50 x 22,5 cm	19 3/4" x 19 3/4" x 10 1/2" 50 x 50 x 26,7 cm	19 3/4" x 19 3/4" x 12 5/8" 50 x 50 x 30,8 cm	19 3/4" x 19 3/4" x 13 3/4" 50 x 50 x 34,9 cm
	LIST PRICE EACH	\$ 54.05	\$ 69.25	\$ 83.55	\$ 99.75	\$ 116.65	\$ 131.90

Full Size Camracks® for Stemware & Tumblers

36 COMPARTMENT

<p>2 7/8" 7.2 cm MAXIMUM DIAMETER</p>	MAXIMUM HEIGHT	3 5/8" 9 cm	4 1/2" 11 cm	5 1/4" 13,2 cm	6 1/8" 15,2 cm	6 7/8" 17,4 cm	7 3/4" 19,4 cm
	CODE	36S318	36S418**	36S434	36S534**	36S638	36S738**
	CASE PACK	5	5	4	4	3	3
	CASE LBS. (CUBE)	29.23 (6.93)	31.78 (6.93)	31.54 (6.93)	33.46 (6.93)	29.97 (6.38)	31.41 (6.38)
	CASE KG (CUBE M³)	13,26 (0,196)	14,42 (0,196)	14,31 (0,196)	15,18 (0,196)	13,60 (0,181)	14,25 (0,181)
	RACK DIMENSION	19 1/4" x 19 1/4" x 5 5/8" 50 x 50 x 14,3 cm	19 1/4" x 19 1/4" x 5 5/8" 50 x 50 x 14,3 cm	19 1/4" x 19 1/4" x 7 1/4" 50 x 50 x 18,4 cm	19 1/4" x 19 1/4" x 7 1/4" 50 x 50 x 18,4 cm	19 1/4" x 19 1/4" x 8 3/8" 50 x 50 x 22,5 cm	19 1/4" x 19 1/4" x 8 3/8" 50 x 50 x 22,5 cm
	LIST PRICE EACH	\$ 54.05	\$ 58.30	\$ 69.25	\$ 75.20	\$ 83.55	\$ 92.90
	MAXIMUM HEIGHT	8 1/2" 21,6 cm	9 3/8" 23,8 cm	10 1/8" 25,8 cm	11" 27,8 cm	11 3/4" 30 cm	12 5/8" 32 cm
	CODE	36S800	36S900**	36S958	36S1058**	36S1114	36S1214**
	CASE PACK	2	2	2	2	2	2
	CASE LBS. (CUBE)	24.48 (4.86)	25.44 (4.86)	28.22 (5.96)	29.18 (5.96)	32.36 (6.93)	33.32 (6.93)
	CASE KG (CUBE M³)	11,10 (0,138)	11,54 (0,138)	12,80 (0,169)	13,24 (0,169)	14,68 (0,196)	15,11 (0,196)
	RACK DIMENSION	19 1/4" x 19 1/4" x 10 1/2" 50 x 50 x 26,7 cm	19 1/4" x 19 1/4" x 10 1/2" 50 x 50 x 26,7 cm	19 1/4" x 19 1/4" x 12 1/4" 50 x 50 x 30,8 cm	19 1/4" x 19 1/4" x 12 1/4" 50 x 50 x 30,8 cm	19 1/4" x 19 1/4" x 13 3/4" 50 x 50 x 34,9 cm	19 1/4" x 19 1/4" x 13 3/4" 50 x 50 x 34,9 cm
	LIST PRICE EACH	\$ 99.75	\$ 110.75	\$ 116.65	\$ 127.65	\$ 131.90	\$ 144.60

** Compartment Extenders cannot be added.

49 COMPARTMENT

<p>2 7/16" 6 cm MAXIMUM DIAMETER</p>	MAXIMUM HEIGHT	3 5/8" 9 cm	5 1/4" 13,2 cm	6 7/8" 17,4 cm	8 1/2" 21,6 cm	10 1/8" 25,8 cm	11 3/4" 30 cm
	CODE	49S318	49S434	49S638	49S800	49S958	49S1114
	CASE PACK	5	4	3	2	2	2
	CASE LBS. (CUBE)	30.93 (6.93)	33.74 (6.93)	32.25 (6.38)	26.42 (4.86)	30.58 (5.96)	35.14 (6.93)
	CASE KG (CUBE M³)	14,03 (0,196)	15,30 (0,196)	14,63 (0,181)	11,98 (0,138)	13,87 (0,169)	15,94 (0,196)
	RACK DIMENSION	19 1/4" x 19 1/4" x 5 5/8" 50 x 50 x 14,3 cm	19 1/4" x 19 1/4" x 7 1/4" 50 x 50 x 18,4 cm	19 1/4" x 19 1/4" x 8 3/8" 50 x 50 x 22,5 cm	19 1/4" x 19 1/4" x 10 1/2" 50 x 50 x 26,7 cm	19 1/4" x 19 1/4" x 12 1/8" 50 x 50 x 30,8 cm	19 1/4" x 19 1/4" x 13 3/4" 50 x 50 x 34,9 cm
	LIST PRICE EACH	\$ 54.90	\$ 70.95	\$ 85.40	\$ 99.75	\$ 118.35	\$ 136.95

Base Rack Colors:



InStock Color: Soft Gray (151). **Extender Color:** Soft Gray (151). ** Compartment Extenders cannot be added.

Personalization available. See Camrack personalization and color coding page. Contact Customer Service for all special orders.

Half Size Camracks® for Stemware & Tumblers

- Very effective for carrying less weight and for storing drinkware in space-restricted locations.
- Ideal for small under-counter glasswashers.



10HS434

8 COMPARTMENT

Camrack Sizing Guides are available at www.cambro.com under Resource Center.

<p>4 1/8" 10,3 cm MAXIMUM DIAMETER</p>	<p>MAXIMUM HEIGHT</p>	3 5/8" 9 cm	5 1/4" 13,2 cm	6 7/8" 17,4 cm	8 1/2" 21,6 cm	10 1/8" 25,8 cm	11 3/4" 30 cm
	CODE	8HS318	8HS434	8HS638	8HS800	8HS958	8HS1114
	CASE PACK	5	4	3	2	2	2
	CASE LBS. (CUBE)	16.96 (3.27)	17.94 (3.54)	16.78 (3.27)	13.57 (2.76)	15.67 (3.06)	17.68 (3.27)
	CASE KG (CUBE M³)	7,69 (0,093)	8,14 (0,100)	7,61 (0,093)	6,16 (0,078)	7,11 (0,087)	8,02 (0,093)
	RACK DIMENSION	19 3/4" x 10" x 5 5/8" 50 x 25 x 14,3 cm	19 3/4" x 10" x 7 1/4" 50 x 25 x 18,4 cm	19 3/4" x 10" x 8 7/8" 50 x 25 x 22,5 cm	19 3/4" x 10" x 10 1/2" 50 x 25 x 26,7 cm	19 3/4" x 10" x 12 5/8" 50 x 25 x 30,8 cm	19 3/4" x 10" x 13 3/4" 50 x 25 x 34,9 cm
	LIST PRICE EACH	\$ 38.90	\$ 53.20	\$ 64.25	\$ 77.70	\$ 91.30	\$ 104.70

10 COMPARTMENT

<p>3 1/2" 8,8 cm MAXIMUM DIAMETER</p>	<p>MAXIMUM HEIGHT</p>	3 5/8" 9 cm	5 1/4" 13,2 cm	6 7/8" 17,4 cm	8 1/2" 21,6 cm	10 1/8" 25,8 cm	11 3/4" 30 cm
	CODE	10HS318	10HS434	10HS638	10HS800	10HS958	10HS1114
	CASE PACK	5	4	3	2	2	2
	CASE LBS. (CUBE)	17.36 (3.27)	18.50 (3.54)	17.38 (3.27)	14.09 (2.76)	16.31 (3.06)	18.44 (3.27)
	CASE KG (CUBE M³)	7,87 (0,093)	8,39 (0,100)	7,88 (0,093)	6,39 (0,078)	7,40 (0,087)	8,36 (0,093)
	RACK DIMENSION	19 3/4" x 10" x 5 5/8" 50 x 25 x 14,3 cm	19 3/4" x 10" x 7 1/4" 50 x 25 x 18,4 cm	19 3/4" x 10" x 8 7/8" 50 x 25 x 22,5 cm	19 3/4" x 10" x 10 1/2" 50 x 25 x 26,7 cm	19 3/4" x 10" x 12 5/8" 50 x 25 x 30,8 cm	19 3/4" x 10" x 13 3/4" 50 x 25 x 34,9 cm
	LIST PRICE EACH	\$ 38.90	\$ 53.20	\$ 64.25	\$ 77.70	\$ 91.30	\$ 104.70

17 COMPARTMENT

<p>2 15/16" 7,3 cm MAXIMUM DIAMETER</p>	<p>MAXIMUM HEIGHT</p>	3 5/8" 9 cm	5 1/4" 13,2 cm	6 7/8" 17,4 cm	8 1/2" 21,6 cm	10 1/8" 25,8 cm	11 3/4" 30 cm
	CODE	17HS318	17HS434	17HS638	17HS800	17HS958	17HS1114
	CASE PACK	5	4	3	2	2	2
	CASE LBS. (CUBE)	18.36 (3.27)	19.82 (3.54)	18.76 (3.27)	15.27 (2.76)	17.75 (3.06)	20.14 (3.27)
	CASE KG (CUBE M³)	8,33 (0,093)	8,99 (0,100)	8,51 (0,093)	6,93 (0,078)	8,05 (0,087)	9,14 (0,093)
	RACK DIMENSION	19 3/4" x 10" x 5 5/8" 50 x 25 x 14,3 cm	19 3/4" x 10" x 7 1/4" 50 x 25 x 18,4 cm	19 3/4" x 10" x 8 7/8" 50 x 25 x 22,5 cm	19 3/4" x 10" x 10 1/2" 50 x 25 x 26,7 cm	19 3/4" x 10" x 12 5/8" 50 x 25 x 30,8 cm	19 3/4" x 10" x 13 3/4" 50 x 25 x 34,9 cm
	LIST PRICE EACH	\$ 40.55	\$ 55.40	\$ 69.85	\$ 84.60	\$ 99.15	\$ 113.25

Base Rack Colors:



119
Sherwood Green



151
Soft Gray



167
Brown



184
Beige



186
Navy Blue



416
Cranberry

Extender Color: Soft Gray (151). Personalization available. See Camrack personalization and color coding page. Contact Customer Service for all special orders.

Camrack® Full & Half Size Cup Racks

Camrack Cup Racks

Tilt feature drains water from mug or cup bases for quick and sanitary drying.

16 COMPARTMENT

4³/₈" X 4³/₈" 11,1 x 11,1 cm COMPARTMENT DIMENSIONS	 MAX. HEIGHT	2⁵/₈" 6,6 cm	4¹/₄" 10,7 cm	5⁷/₈" 14,9 cm
	CODE	16C258	16C414	16C578
	CASE PACK	6	5	4
	CASE LBS. (CUBE)	28.78 (4.81)	32.48 (6.93)	32.86 (6.93)
	CASE KG (CUBE M³)	13,05 (0,136)	14,73 (0,196)	14,91 (0,196)
	RACK DIMENSION	19 ³ / ₄ " x 19 ³ / ₄ " x 4" 50 x 50 x 10,1 cm	19 ³ / ₄ " x 19 ³ / ₄ " x 5 ⁷ / ₈ " 50 x 50 x 14,3 cm	19 ³ / ₄ " x 19 ³ / ₄ " x 7 ¹ / ₄ " 50 x 50 x 18,4 cm
	LIST PRICE EACH	\$ 36.70	\$ 51.15	\$ 76.40



16C414

InStock Color: Soft Gray (151).

20 COMPARTMENT

4³/₈" X 3¹/₂" 11,1 x 8,8 cm COMPARTMENT DIMENSIONS	 MAX. HEIGHT	2⁵/₈" 6,6 cm	4¹/₄" 10,7 cm
	CODE	20C258	20C414
	CASE PACK	6	5
	CASE LBS. (CUBE)	29.28 (4.81)	32.53 (6.93)
	CASE KG (CUBE M³)	13,28 (0,136)	14,76 (0,196)
	RACK DIMENSION	19 ³ / ₄ " x 19 ³ / ₄ " x 4" 50 x 50 x 10,1 cm	19 ³ / ₄ " x 19 ³ / ₄ " x 5 ⁷ / ₈ " 50 x 50 x 14,3 cm
	LIST PRICE EACH	\$ 38.05	\$ 52.35



InStock Color: Soft Gray (151).

Glass and Cup Keepers

- Raised ribs for easy draining and drying.
- Holds 20 glasses or 12 cups per layer.

Color: Beige (133).



8 COMPARTMENT

4¹/₈" X 4⁷/₁₆" 10,4 x 11,3 cm COMPARTMENT DIMENSIONS	 MAX. HEIGHT	2⁵/₈" 6,6 cm	4¹/₄" 10,7 cm
	CODE	8HC258	8HC414
	CASE PACK	6	5
	CASE LBS. (CUBE)	16.15 (2.76)	18.66 (3.27)
	CASE KG (CUBE M³)	7,32 (0,078)	8,46 (0,093)
	RACK DIMENSION	19 ³ / ₄ " x 9 ¹ / ₂ " x 4" 50 x 25 x 10,1 cm	19 ³ / ₄ " x 9 ¹ / ₂ " x 5 ⁷ / ₈ " 50 x 25 x 14,3 cm
	LIST PRICE EACH	\$ 26.20	\$ 43.45



Max. Glass Inside Rim Diameter:
GK2000: 2⁵/₈" (6,6 cm)



Max. Cup Inside Rim Diameter:
KK1200: 2¹/₂" (7,4 cm)

10 COMPARTMENT

4¹/₈" X 3¹/₂" 10,4 x 8,8 cm COMPARTMENT DIMENSIONS	 MAX. HEIGHT	2⁵/₈" 6,6 cm	4¹/₄" 10,7 cm
	CODE	10HC258	10HC414
	CASE PACK	6	5
	CASE LBS. (CUBE)	16.73 (2.76)	19.76 (3.27)
	CASE KG (CUBE M³)	7,59 (0,078)	8,96 (0,093)
	RACK DIMENSION	19 ³ / ₄ " x 9 ¹ / ₂ " x 4" 50 x 25 x 10,1 cm	19 ³ / ₄ " x 9 ¹ / ₂ " x 5 ⁷ / ₈ " 50 x 25 x 14,3 cm
	LIST PRICE EACH	\$ 26.20	\$ 43.45



CODE	SIZE	CASE LBS. (CUBE)	LIST PRICE EA.
Glass Keepers			
GK2000	14" x 18"	16 (0.94)	\$ 17.40
Cup Keepers			
KK1200	13 ¹⁵ / ₁₆ " x 17 ⁷ / ₈ "	14.25 (0.78)	16.35

Case Pack: 12

Base Cup Rack Color: Soft Gray (151). Extender Color: Soft Gray (151). Personalization available. See Camrack personalization and color coding page.

Contact Customer Service for all special orders.

www.cambro.com

Camrack® Base Racks

- For pots, pans, bowls and large prep, service and display items.
- Half racks work well for storing items at a wait station.



BR578

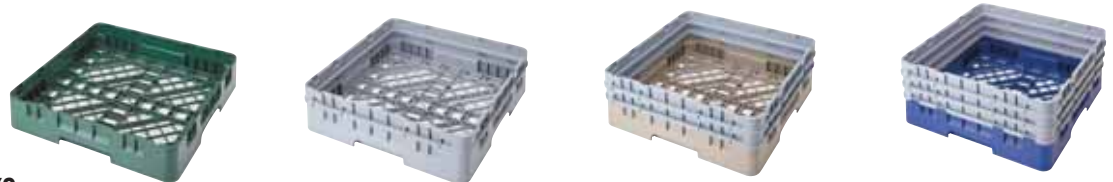

FULL SIZE BASE RACKS

	FULL BASE RACK	WITH 1 EXTENDER	WITH 2 EXTENDERS	WITH 3 EXTENDERS
CODE	BR258	BR414	BR578	BR712
INSIDE RACK HEIGHT	3¼" (8,3 cm)	4⅞" (12,4 cm)	6½" (16,5 cm)	8⅞" (20,6 cm)
OUTSIDE RACK HEIGHT	4" (10,1 cm)	5⅞" (14,3 cm)	7¼" (18,4 cm)	8⅞" (22,5 cm)
CASE PACK	6	5	4	3
CASE LBS. (CUBE)	22.02 (4.81)	24.58 (6.93)	24.98 (6.93)	22.92 (6.38)
CASE KG (CUBE M³)	9,99 (0,136)	11,15 (0,196)	11,33 (0,196)	10,39 (0,181)
RACK DIMENSION	19¾" x 19¾" x 4" 50 x 50 x 10,1 cm	19¾" x 19¾" x 5⅞" 50 x 50 x 14,3 cm	19¾" x 19¾" x 7¼" 50 x 50 x 18,4 cm	19¾" x 19¾" x 8⅞" 50 x 50 x 22,5 cm
LIST PRICE EACH	\$ 33.70	\$ 49.05	\$ 62.90	\$ 77.20

InStock Color: Soft Gray (151).



HALF SIZE BASE RACKS

	HALF BASE RACK	WITH 1 EXTENDER	WITH 2 EXTENDERS	WITH 3 EXTENDERS
CODE	HBR258	HBR414	HBR578	HBR712
INSIDE RACK HEIGHT	3¼" (8,3 cm)	4⅞" (12,4 cm)	6½" (16,5 cm)	8⅞" (20,6 cm)
OUTSIDE RACK HEIGHT	4" (10,1 cm)	5⅞" (14,3 cm)	7¼" (18,4 cm)	8⅞" (22,5 cm)
CASE PACK	6	5	4	3
CASE LBS. (CUBE)	13.72 (2.76)	16.06 (3.27)	16.66 (3.54)	15.40 (3.27)
CASE KG (CUBE M³)	6,22 (0,078)	7,29 (0,093)	7,56 (0,100)	6,99 (0,093)
RACK DIMENSION	19¾" x 9⅞" x 4" 50 x 25 x 10,1 cm	19¾" x 9⅞" x 5⅞" 50 x 25 x 14,3 cm	19¾" x 9⅞" x 7¼" 50 x 25 x 18,4 cm	19¾" x 9⅞" x 8⅞" 50 x 25 x 22,5 cm
LIST PRICE EACH	\$ 22.85	\$ 36.75	\$ 47.35	\$ 58.30

Hold Down Grid

Keeps lightweight smallwares in place during wash cycle. Use on full size Camrack base rack.



CRPHDG2878

	FULL SIZE HOLD DOWN GRID
CODE	CRPHDG2878
CASE LBS. (CUBE)	11.05 (0.49)
CASE KG (CUBE M³)	4,60 (0,013)
LIST PRICE EACH	\$ 25.85

Case Pack: 6 Color: Gray (000).

Base Rack Colors:

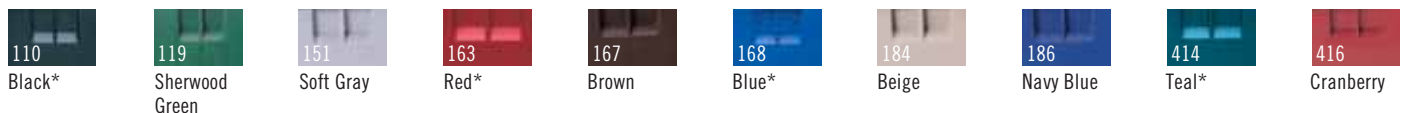

* Full size only. Extender Color: Soft Gray (151). Personalization available. See Camrack personalization and color coding page. Contact Customer Service for all special orders.

Camrack® Full Size Peg Racks & Tray Rack

Standard 9 x 9 Peg Rack

- Designed to wash varying sized plates, bowls, trays and plate covers.
- Standard peg racks hold:
 - Eighteen 10" (25,4 cm) plates
 - Twelve 12" (30,5 cm) plates
 - Twenty-seven 7½" (19 cm) plates
 or
 - Nine 14" x 18" (36 x 46 cm) trays

5 x 9 Peg Rack

- Holds standard plates in one direction or deep plates, bowls and plate covers in the other direction.
- 5 spacing configuration holds up to ten 10" bowls, deep plates, platters or plate covers.

- 9 spacing configuration holds up to:
 - Eighteen 10" (25,4 cm) plates
 - Twelve 12" (30,5 cm) plates
 - Twenty-seven 7½" (19 cm) plates
 or
 - Nine 14" x 18" (36 x 46 cm) trays

Open End Tray Rack

- Holds cafeteria trays or full-size sheet pans.
- Open-ended on one side for easy placement and removal of trays of all lengths.
- Holds up to nine trays upright.



	9 X 9 PEG RACK	9 X 9 PEG RACK WITH 1 EXTENDER	5 X 9 PEG RACK	5 X 9 PEG RACK WITH 1 EXTENDER	OPEN END TRAY RACK
CODE	PR314	PR500	PR59314	PR59500	OETR314*
INSIDE RACK HEIGHT	3¼" (8,3 cm)	4⅞" (12,4 cm)	3¼" (8,3 cm)	4⅞" (12,4 cm)	3¼" (8,3 cm)
OUTSIDE RACK HEIGHT	4" (10,1 cm)	5⅝" (14,3 cm)	4" (10,1 cm)	5⅝" (14,3 cm)	4" (10,1 cm)
CASE PACK	6	5	6	5	6
CASE LBS. (CUBE)	27.25 (4.81)	29.28 (6.93)	24.15 (4.81)	26.93 (6.93)	25.84 (4.81)
CASE KG (CUBE M³)	12,36 (0,136)	13,28 (0,196)	10,95 (0,136)	12,22 (0,196)	11,72 (0,136)
LIST PRICE EACH	\$ 36.30	\$ 51.60	\$ 36.30	\$ 51.60	\$ 35.55

Color: Soft Gray (151). Extender Color: Soft Gray (151). InStock Color: Soft Gray (151). Personalization available. See Camrack personalization and color coding page. Contact Customer Service for all special orders. *Extenders may be added to all Peg Racks except the OETR314.

Camrack Full & Half Size Flatware Racks & Cylinders

Camrack Flatware Racks

- 8 Compartment Basket fits into a Full or Half Size Base Rack. Wire handles slide down for easy storage.
- Flatware Cylinder fits into 9-compartment Full Size Camrack and the Cambro Tray and Dish Cart, model TDCR12.



	FULL FLATWARE RACK	HALF FLATWARE RACK	8 COMPARTMENT HALF FLATWARE BASKET	8 COMPARTMENT HALF FLATWARE BASKET	FLATWARE CYLINDER
CODE	FR258	HFR258	8FB434* With Handles	8FBNH434* No Handles	FWC56
INSIDE RACK HEIGHT	2⅝" (6,7 cm)	2⅝" (6,7 cm)	4¼" (12 cm)	4¼" (12 cm)	4½" wide (11,43 cm)
OUTSIDE RACK HEIGHT	4" (10,1 cm)	4" (10,1 cm)	7¼" (18,4 cm)	7¼" (18,4 cm)	5½" high (13,97 cm)
CASE PACK	6	6	6	6	12
CASE LBS. (CUBE)	24.79 (4.81)	15.26 (2.76)	19.49 (3.67)	17.46 (3.67)	2.76 (0.41)
CASE KG (CUBE M³)	11,25 (0,136)	6,92 (0,078)	8,17 (0,105)	8,16 (0,105)	1,24 (0,012)
LIST PRICE EACH	\$ 36.30	\$ 31.30	\$ 43.10	\$ 25.35	\$ 4.40

Color: Soft Gray (151). Extender Color: Soft Gray (151). InStock Color: Soft Gray (151). Flatware Cylinder Color: White (148). Personalization available. See Camrack personalization and color coding page. Contact Customer Service for all special orders. * Extenders cannot be added.

PlateSafe® Camrack®

- Effectively store and transport dinnerware.
- Vinyl-coated steel grids safely hold and separate plates within each rack.
- Add a Camdolly® and Cover to create a completely enclosed, sanitary storage unit between uses.
- Reduces breakage.
- Holds plates upright and securely in place.
- No need to transfer to dish caddies, reducing labor.



CRPH1656
Half Size PlateSafe Camrack



Transport racks to banquet area for quick set up.



PlateSafe Camracks

13 different styles of full size PlateSafe Camracks to transport plates from 4" to 12½" (10,1-31,7 cm) in diameter.

Portable Sanitary Storage System

Completely enclose and protect dinnerware by stacking racks on a Camdolly and covering with a Camrack cover.

PLATE SIZE	4-5"	4-6"	5-6"	6-7"	6-7 ⁵ / ₈ "	7-8 ⁵ / ₈ "	9-10 ¹ / ₄ "	9-10 ¹ / ₂ "
	10,1-12,7 cm	10,1-15,2 cm	12,7-15,2 cm	15,2-17,7 cm	15,2-19,3 cm	17,7-21,9 cm	22,8-26 cm	22,8-26,6 cm
MAX. PLATE HEIGHT	¾" (1,9 cm)	2" (5 cm)	¾" (1,9 cm)	¾" (1,9 cm)	1" (2,5 cm)	1" (2,5 cm)	1" (2,5 cm)	1¼" (4,4 cm)
# OF PLATES	63	20	48	44	30	28	20	12
CODE	CRP6345	CRP2046	CRP4856	CRP4467	CRP3067	CRP2878	CRP20910	CRP12910
RACK SIZE	FULL	FULL	FULL	FULL	FULL	FULL	FULL	FULL
EXT. RACK HEIGHT	7¼" (18,4 cm)	7¼" (18,4 cm)	7¼" (18,4 cm)	8½" (22,5 cm)	8½" (22,5 cm)	10½" (26,7 cm)	12½" (30,8 cm)	12½" (30,8 cm)
CASE PACK	2	2	2	2	2	1	1	1
CASE LBS (CUBE)	22.45 (3.43)	17.44 (3.48)	20.54 (3.43)	31.42 (4.27)	19.5 (4.03)	12.94 (2.59)	14.08 (2.97)	11.1 (2.83)
CASE KG (CUBE M ³)	8,71 (0,092)	7,17 (0,092)	8,35 (0,092)	9,39 (0,114)	8,85 (0,114)	4,9 (0,07)	5,31 (0,08)	5,03 (0,08)
LIST PRICE EACH	\$ 137.45	\$ 137.45	\$ 137.45	\$ 148.50	\$ 137.45	\$ 137.45	\$ 159.90	\$ 140.80

PLATE SIZE	9-11 ¹ / ₈ "	9-11"	10-11"	10½-12½"	11½-12½"	5-6 ⁷ / ₈ "
	22,8-28,2 cm	22,8-27,9 cm	25,4-27,9 cm	26,6-31,7 cm	29,2-31,7 cm	12,7-17,5 cm
MAX. PLATE HEIGHT	1¾" (4,4 cm)	2½" (5,7 cm)	1" (2,5 cm)	1¾" (3,4 cm)	1" (2,5 cm)	1" (2,5 cm)
# OF PLATES	12	9	19	14	18	16
CODE	CRP12911	CRP9911	CRP191011	CRP141012	CRP181112	CRPH1656
RACK SIZE	FULL	FULL	FULL	FULL	FULL	HALF
EXT. RACK HEIGHT	12½" (30,8 cm)	12½" (30,8 cm)	12½" (30,8 cm)	13¾" (34,9 cm)	13¾" (34,9 cm)	7¼" (18,4 cm)
CASE PACK	1	1	1	1	1	4
CASE LBS (CUBE)	15.07 (3.08)	11.95 (2.83)	15.42 (3.00)	13.85 (3.26)	14.45 (3.26)	23.52 (3.53)
CASE KG (CUBE M ³)	5,49 (0,08)	5,42 (0,08)	5,96 (0,08)	6,28 (0,092)	6,55 (0,092)	10,67 (0,1)
LIST PRICE EACH	\$ 180.05	\$ 180.05	\$ 180.05	\$ 195.80	\$ 203.45	\$ 109.25



* Full size only. Extender Color: Soft Gray (151). Personalization available. See Camrack personalization and color coding page. Contact Customer Service for all special orders.

Camrack® Component System

The Camrack System offers several choices for ordering the right Camracks and PlateSafe® Racks. Please consult with your sales representative or Cambro Customer Service for all special ordering and assembly directions.

Choose Between:

1. A complete selection of pre-assembled, ready to use Camracks listed in our catalog, or
2. Custom built special order Camracks for specific needs, or
3. Individual Camrack components for distributors to stock and build racks as needed.

Base Rack Colors:

Sherwood Green (119), Soft Gray (151), Brown (167), Beige (184), Navy Blue (186), Cranberry (416), Black (110)*, Red (163)*, Blue (168)*, Teal (414)*.

Base Cup Rack Color: Soft Gray (151).

Extender Color: Soft Gray (151).

PlateSafe Grid Color: Gray (000).

* Full size only.

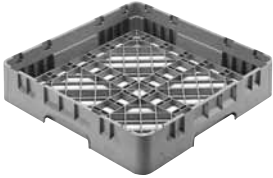

BR = Full Size Base Rack



HBR = Half Size Base Rack



E1 = Full Size Full Drop Compartment Extender



HE1 = Half Size Full Drop Compartment Extender



E2 = Full Size Half Drop Compartment Extender



HE2 = Half Size Half Drop Compartment Extender



E3 = Full Size Open Extender



HE3 = Half Size Open Extender



E4 = Full Size Full Drop Stemware Extender



E5 = Full Size Half Drop Stemware Extender

CAMRACK COMPONENTS

Only E3 extenders may be added to E4's and E5's.

CODE	DESCRIPTION	OVERALL DIMENSIONS	COMPARTMENT	INSIDE RACK HEIGHT	CASE PACK	CASE LBS. (CUBE)	LIST PRICE EA.
Full Size Base Racks							
BR258	Full Base Rack	19 $\frac{3}{4}$ " x 19 $\frac{3}{4}$ " x 4" (500 x 500 x 101 mm)	18" x 18" (457 x 457 mm)	2 $\frac{5}{8}$ " (67 mm)	6	22.02 (4.81)	\$ 33.70
Half Size Base Racks							
HBR258	Half Base Rack	19 $\frac{3}{4}$ " x 9 $\frac{3}{4}$ " x 4" (500 x 250 x 101 mm)	18 $\frac{1}{4}$ " x 8 $\frac{3}{8}$ " (464 x 213 mm)	2 $\frac{5}{8}$ " (67 mm)	6	13.72 (2.76)	22.85
Full Size Base Cup Racks							
16C258	16-Compartment Full Cup Rack	19 $\frac{3}{4}$ " x 19 $\frac{3}{4}$ " x 4" (500 x 500 x 101 mm)	4 $\frac{3}{8}$ " x 4 $\frac{3}{8}$ " (111 x 111 mm)	2 $\frac{5}{8}$ " (67 mm)	6	28.78 (4.81)	36.70
20C258	20-Compartment Full Cup Rack	19 $\frac{3}{4}$ " x 19 $\frac{3}{4}$ " x 4" (500 x 500 x 101 mm)	4 $\frac{3}{8}$ " x 3 $\frac{1}{2}$ " (111 x 89 mm)	2 $\frac{5}{8}$ " (67 mm)	6	29.28 (4.81)	38.05
Half Size Base Cup Racks							
8HC258	8-Compartment Half Cup Rack	19 $\frac{3}{4}$ " x 9 $\frac{3}{4}$ " x 4" (500 x 250 x 101 mm)	4 $\frac{7}{8}$ " x 4 $\frac{1}{16}$ " (105 x 113 mm)	2 $\frac{5}{8}$ " (67 mm)	6	16.15 (2.76)	26.20
10HC258	10-Compartment Half Cup Rack	19 $\frac{3}{4}$ " x 9 $\frac{3}{4}$ " x 4" (500 x 250 x 101 mm)	4 $\frac{7}{8}$ " x 3 $\frac{1}{2}$ " (105 x 89 mm)	2 $\frac{5}{8}$ " (67 mm)	6	16.73 (2.76)	26.20
Full Size Full Drop Extenders – E1 and G1							
9E1	9-Compartment Full Drop Extender	19 $\frac{5}{8}$ " x 19 $\frac{5}{8}$ " x 2" (499 x 499 x 51 mm)	5 $\frac{7}{8}$ " x 5 $\frac{7}{8}$ " (150 x 150 mm)	1 $\frac{1}{8}$ " (41 mm)	12	25.34 (6.93)	15.50
16E1	16-Compartment Full Drop Extender	19 $\frac{5}{8}$ " x 19 $\frac{5}{8}$ " x 2" (499 x 499 x 51 mm)	4 $\frac{3}{8}$ " x 4 $\frac{3}{8}$ " (111 x 111 mm)	1 $\frac{1}{8}$ " (41 mm)	12	23.30 (6.93)	16.45
20GE1	20-Compartment Full Drop Extender	19 $\frac{5}{8}$ " x 19 $\frac{5}{8}$ " x 2" (499 x 499 x 51 mm)	3 $\frac{7}{8}$ " x 3 $\frac{7}{8}$ " (98 x 98 mm)	1 $\frac{1}{8}$ " (41 mm)	12	25.8 (7.33)	17.35
25E1	25-Compartment Full Drop Extender	19 $\frac{5}{8}$ " x 19 $\frac{5}{8}$ " x 2" (499 x 499 x 51 mm)	3 $\frac{1}{2}$ " x 3 $\frac{1}{2}$ " (89 x 89 mm)	1 $\frac{1}{8}$ " (41 mm)	12	25.46 (6.93)	17.35
30GE1	30-Compartment Full Drop Extender	19 $\frac{5}{8}$ " x 19 $\frac{5}{8}$ " x 2" (499 x 499 x 51 mm)	3 $\frac{3}{8}$ " x 3 $\frac{3}{8}$ " (79 x 79 mm)	1 $\frac{1}{8}$ " (41 mm)	12	28.4 (7.33)	17.65
36E1	36-Compartment Full Drop Extender	19 $\frac{5}{8}$ " x 19 $\frac{5}{8}$ " x 2" (499 x 499 x 51 mm)	2 $\frac{7}{8}$ " x 2 $\frac{7}{8}$ " (73 x 73 mm)	1 $\frac{1}{8}$ " (41 mm)	12	28.02 (6.93)	17.65
49E1	49-Compartment Full Drop Extender	19 $\frac{5}{8}$ " x 19 $\frac{5}{8}$ " x 2" (499 x 499 x 51 mm)	2 $\frac{1}{16}$ " x 2 $\frac{1}{16}$ " (62 x 62 mm)	1 $\frac{1}{8}$ " (41 mm)	12	32.30 (6.93)	17.65
Full Size Half Drop Extenders – E2 and G2							
9E2	9-Compartment Half Drop Extender	19 $\frac{5}{8}$ " x 19 $\frac{5}{8}$ " x 2" (499 x 499 x 51 mm)	5 $\frac{7}{8}$ " x 5 $\frac{7}{8}$ " (150 x 150 mm)	1 $\frac{1}{8}$ " (41 mm)	12	21.62 (6.93)	14.60
16E2	16-Compartment Half Drop Extender	19 $\frac{5}{8}$ " x 19 $\frac{5}{8}$ " x 2" (499 x 499 x 51 mm)	4 $\frac{3}{8}$ " x 4 $\frac{3}{8}$ " (111 x 111 mm)	1 $\frac{1}{8}$ " (41 mm)	12	21.75 (6.93)	14.60
20E2	20-Compartment Half Drop Extender (for cups only)	19 $\frac{5}{8}$ " x 19 $\frac{5}{8}$ " x 2" (499 x 499 x 51 mm)	4 $\frac{3}{8}$ " x 3 $\frac{1}{2}$ " (111 x 89 mm)	1 $\frac{1}{8}$ " (41 mm)	12	22.22 (6.93)	13.55
20GE2	20-Compartment Half Drop Extender	19 $\frac{5}{8}$ " x 19 $\frac{5}{8}$ " x 2" (499 x 499 x 51 mm)	3 $\frac{7}{8}$ " x 3 $\frac{7}{8}$ " (98 x 98 mm)	1 $\frac{1}{8}$ " (41 mm)	12	23.4 (7.33)	15.05
25E2	25-Compartment Half Drop Extender	19 $\frac{5}{8}$ " x 19 $\frac{5}{8}$ " x 2" (499 x 499 x 51 mm)	3 $\frac{1}{2}$ " x 3 $\frac{1}{2}$ " (89 x 89 mm)	1 $\frac{1}{8}$ " (41 mm)	12	23.06 (6.93)	15.05
30GE2	30-Compartment Half Drop Extender	19 $\frac{5}{8}$ " x 19 $\frac{5}{8}$ " x 2" (499 x 499 x 51 mm)	3 $\frac{3}{8}$ " x 3 $\frac{3}{8}$ " (79 x 79 mm)	1 $\frac{1}{8}$ " (41 mm)	12	25.2 (7.33)	15.90

Camrack® / PlateSafe® Component System

CODE	DESCRIPTION	OVERALL DIMENSIONS	COMPARTMENT	INSIDE RACK HEIGHT	CASE PACK	CASE LBS. (CUBE)	LIST PRICE EA.
Full Size Half Drop Extenders – E2 and GE2 (continued)							
36E2	36-Compartment Half Drop Extender	19 ³ / ₈ " x 19 ³ / ₈ " x 2" (499 x 499 x 51 mm)	2 ⁷ / ₈ " x 2 ⁷ / ₈ " (73 x 73 mm)	1 ⁵ / ₈ " (41 mm)	12	25.58 (6.93)	\$ 15.90
49E2	49-Compartment Half Drop Extender	19 ³ / ₈ " x 19 ³ / ₈ " x 2" (499 x 499 x 51 mm)	2 ⁷ / ₁₆ " x 2 ⁷ / ₁₆ " (62 x 62 mm)	1 ⁵ / ₈ " (41 mm)	12	28.10 (6.93)	15.90
Full Size Open Extender – E3							
E3	Open Extender	19 ³ / ₈ " x 19 ³ / ₈ " x 2" (499 x 499 x 51 mm)	18" x 18" (457 x 457 mm)	1 ⁵ / ₈ " (41 mm)	12	16.90 (5.52)	12.45
Full Size Full Drop Extender – E4							
16E4	16-Compartment Full Drop Extender	19 ³ / ₈ " x 19 ³ / ₈ " x 2" (499 x 499 x 51 mm)	4 ³ / ₈ " x 4 ³ / ₈ " (111 x 111 mm)	1 ⁵ / ₈ " (41 mm)	12	26.78 (6.93)	17.65
25E4	25-Compartment Full Drop Extender	19 ³ / ₈ " x 19 ³ / ₈ " x 2" (499 x 499 x 51 mm)	3 ¹ / ₂ " x 3 ¹ / ₂ " (89 x 89 mm)	1 ⁵ / ₈ " (41 mm)	12	30.38 (6.93)	20.20
36E4	36-Compartment Full Drop Extender	19 ³ / ₈ " x 19 ³ / ₈ " x 2" (499 x 499 x 51 mm)	2 ⁷ / ₈ " x 2 ⁷ / ₈ " (73 x 73 mm)	1 ⁵ / ₈ " (41 mm)	12	34.34 (6.93)	22.85
Full Size Half Drop Extender – E5							
16E5	16-Compartment Half Drop Extender	19 ³ / ₈ " x 19 ³ / ₈ " x 2" (499 x 499 x 51 mm)	4 ³ / ₈ " x 4 ³ / ₈ " (111 x 111 mm)	1 ⁵ / ₈ " (41 mm)	12	25.34 (6.93)	15.55
25E5	25-Compartment Half Drop Extender	19 ³ / ₈ " x 19 ³ / ₈ " x 2" (499 x 499 x 51 mm)	3 ¹ / ₂ " x 3 ¹ / ₂ " (89 x 89 mm)	1 ⁵ / ₈ " (41 mm)	12	28.22 (6.93)	16.95
36E5	36-Compartment Half Drop Extender	19 ³ / ₈ " x 19 ³ / ₈ " x 2" (499 x 499 x 51 mm)	2 ⁷ / ₈ " x 2 ⁷ / ₈ " (73 x 73 mm)	1 ⁵ / ₈ " (41 mm)	12	31.34 (6.93)	17.65
Half Size Full Drop Extenders – HE1							
8HE1	8-Compartment Full Drop Extender	19 ³ / ₄ " x 9 ³ / ₈ " x 2" (502 x 252 x 51 mm)	4 ¹ / ₈ " x 4 ¹ / ₈ " (105 x 113 mm)	1 ⁵ / ₈ " (41 mm)	12	14.10 (3.54)	13.80
10HE1	10-Compartment Full Drop Extender	19 ³ / ₄ " x 9 ³ / ₈ " x 2" (502 x 252 x 51 mm)	4 ¹ / ₈ " x 3 ¹ / ₂ " (105 x 89 mm)	1 ⁵ / ₈ " (41 mm)	12	15.06 (3.54)	13.80
17HE1	17-Compartment Full Drop Extender	19 ³ / ₄ " x 9 ³ / ₈ " x 2" (502 x 252 x 51 mm)	∅ 2 ¹⁵ / ₁₆ " (∅ 74 mm)	1 ⁵ / ₈ " (41 mm)	12	17.46 (3.54)	14.40
Half Size Half Drop Extenders – HE2							
8HE2	8-Compartment Half Drop Extender	19 ³ / ₄ " x 9 ³ / ₈ " x 2" (502 x 252 x 51 mm)	4 ¹ / ₈ " x 4 ¹ / ₁₆ " (105 x 113 mm)	1 ⁵ / ₈ " (41 mm)	12	13.62 (3.54)	12.40
10HE2	10-Compartment Half Drop Extender	19 ³ / ₄ " x 9 ³ / ₈ " x 2" (502 x 252 x 51 mm)	4 ¹ / ₈ " x 3 ¹ / ₂ " (105 x 89 mm)	1 ⁵ / ₈ " (41 mm)	12	14.34 (3.54)	12.95
17HE2	17-Compartment Half Drop Extender	19 ³ / ₄ " x 9 ³ / ₈ " x 2" (502 x 252 x 51 mm)	∅ 2 ¹⁵ / ₁₆ " (∅ 74 mm)	1 ⁵ / ₈ " (41 mm)	12	15.90 (3.54)	13.80
Half Size Open Extenders – HE3							
HE3	Open Extender	19 ³ / ₄ " x 9 ³ / ₈ " x 2" (502 x 252 x 51 mm)	18 ³ / ₄ " x 8 ³ / ₈ " (464 x 213 mm)	1 ⁵ / ₈ " (41 mm)	12	11.94 (3.54)	11.05

∅ = Diameter

PlateSafe Camrack Grids

CODE	DESCRIPTION	DIMENSIONS	CASE PACK	CASE LBS (CUBE)	LIST PRICE EA.
Full Size PlateSafe Grids					
CRPG6345	Holds 63 plates, 4"-5"	18" x 18"	12	28.82 (0.92)	\$ 35.05
CRPG2046	Holds 20 plates, 4"-6"	18" x 18"	12	17.29 (0.92)	35.05
CRPG4856	Holds 48 plates, 5"-6"	18" x 18"	12	26.83 (0.92)	35.05
CRPG4467	Holds 44 plates, 6"-7"	18" x 18"	12	26.23 (0.92)	34.30
CRPG3067	Holds 30 plates, 6"-7 ⁵ / ₈ "	18" x 18"	12	21.79 (0.92)	29.70
CRPG2878	Holds 28 plates, 7"-8 ³ / ₈ "	18" x 18"	12	21.44 (0.92)	24.35
CRPG20910	Holds 20 plates, 9"-10 ¹ / ₄ "	18" x 18"	12	19.93 (0.92)	28.35
CRPG12910	Holds 12 plates, 9"-10 ¹ / ₂ "	18" x 18"	12	15.91 (0.92)	20.35
CRPG12911	Holds 12 plates, 9"-11 ¹ / ₈ "	18" x 18"	12	17.71 (0.92)	24.65
CRPG9911	Holds 9 plates, 9"-11"	18" x 18"	12	14.53 (0.92)	24.65
CRPG191011	Holds 19 plates, 10"-11"	18" x 18"	12	19.91 (0.92)	26.85
CRPG141012	Holds 14 plates, 10 ¹ / ₂ "-12 ¹ / ₂ "	18" x 18"	12	17.29 (0.82)	25.50
CRPG181112	Holds 18 plates, 11"-12 ¹ / ₂ "	18" x 18"	12	21.10 (0.92)	28.70
Half Size PlateSafe Grid					
CRPHG1656	Holds 16 plates, 5"-6 ⁵ / ₈ "	18 ¹ / ₄ " x 8 ³ / ₈ "	12	13 (0.49)	28.05
PlateSafe Hold Down Grid					
CRPHDG2878	Fits all full size base racks	18" x 18"	6	11.05 (0.49)	25.85

Base Rack Colors: Sherwood Green (119), Soft Gray (151), Brown (167), Beige (184), Navy Blue (186), Cranberry (416), Black (110)*, Red (163)*, Blue (168)*, Teal (414)*. **Base Cup Rack Color:** Soft Gray (151). **Extender Color:** Soft Gray (151). * Color available in full size only. All extenders are available in Soft Gray (151). All pre-assembled racks ship with Soft Gray (151) extenders. Sherwood Green, Brown, Navy Blue and Cranberry base racks can be ordered with same color extenders with a minimum special order of 600 racks. **PlateSafe Grid Color:** Gray (000).

Promote Your Brand – Personalized Camracks®

Personalize Camracks to identify contents at a glance for accurate inventory control and selection.

Hot stamp a custom logo, information or standard content symbols, and/or descriptions on two opposite, diagonal sides of any rack.

Or request the addition of pre-printed clips. Up to 4 Camrack or PlateSafe clips can be added **only at time of assembly** and require the addition of at least one extender.



IMPRINT COLOR-WHITE



HOW TO ORDER A SAMPLE

1. Contact your local Cambro rep to complete and submit a sample request form to Cambro. Indicate location of hot stamp and/or clip on rack. Maximum hot stamp imprint size is 4" W x 1 ¼" H. Maximum hot stamp imprinting thickness per solid letter or logo should be no more than 4" wide.
2. If selecting custom hot stamping, provide ready-to-use artwork, in digital format only. Sample request form must be submitted to Cambro **PRIOR** to artwork being sent. If artwork is incomplete, graphic support services are available for \$ 50.00 per hour.
3. E-mail artwork to Cambro Rep or to Cambro at letsgetpersonal@cambro.com.

Title e-mail subject with logo name and provide contact info.

File dimensions:

100% reproduction size, 300dpi resolution.

File type: Adobe® Illustrator®, Photoshop®, or QuarkXpress®.

File format: JPEG, TIFF or EPS.

Or mail artwork on a CD-ROM to: Cambro Manufacturing Company
Attn: Kristie Patterson,
7601 Clay Avenue,
Huntington Beach, CA 92648.

4. Questions? Contact Kristie Patterson at 714-230-4125 direct or 800-854-7631 ext. 4125.
5. Signed approval form must be faxed to Cambro customer service prior to producing product. Approval form included with each sample rack.

PERSONALIZATION OPTIONS

HOT STAMPING



CUSTOM LOGO AND/OR TEXT



STANDARD SYMBOL AND DESCRIPTION



STANDARD SYMBOL ONLY



STANDARD DESCRIPTION ONLY

CAMRACK CLIPS



WITH SYMBOL AND DESCRIPTION

PERSONALIZATION CHARGES (NET)

One Time Plate Charge	\$ 75.00 (for custom hot stamp only)
Set-Up Charge	\$ 50.00
Sample Charge	\$ 50.00
Imprint Charge	\$ 1.00 per side, 2 sides max for hot stamping

FOR CLIPS

Drinkware or PlateSafe®, pre-printed \$ 0.90 each net

Standard Hot Stamp Symbols and/or Descriptions

(also available on clips, symbol and description combined)

- | | |
|---|--|
|  Wine |  Cup |
|  Martini |  Champagne Flute |
|  Rock (footed style) |  Grande |
|  Beer Mug |  Goblet |
|  Hi-Ball |  Sorbet |
|  Hurricane |  Rock (tumbler style) |
|  White Wine |  Creamer |
|  Brandy |  Beer |
|  Water (footed style) |  Collins |
|  Coffee Mug |  Champagne |
|  Margarita |  Cordial |
|  Pilsner |  Iced Tea |
|  Red Wine |  Decanter |
|  Sherry |  Old Fashion |
|  Water (tumbler style) |  Flatware |
|  Irish Coffee |  Shot Glass |
|  Juice |  Port |



(Available in English Only)

Standard PlateSafe® Clips

DINNER



APPETIZER



SALAD



SOUP



PASTA



BREAD



SAUCER



DESSERT



(Available in English Only)

Camrack® Accessories

Camrack Cover & Camdolly®

- Use to cover and protect full size Camrack dishracks filled with clean dishware.
- When used with a Camdolly, creates a portable sanitary storage system that protects contents between uses.

- Eliminates the use of messy, wasteful plastic wrap or vinyl covers.



FULL RACK COVER	
CODE	DRC2020
EXTERIOR DIMENSIONS	19 $\frac{3}{8}$ " x 19 $\frac{3}{8}$ " x 1 $\frac{5}{16}$ " (50 x 50 x 2,4 cm)
CASE LBS. (CUBE)	4.2 (0.34)
CASE KG (CUBE M³)	0,91 (0,0098)
LIST PRICE EACH	\$ 55.55

Case Pack: 1 InStock Color: Gray (180).

	CAMDOLLY	CAMDOLLY WITH HANDLE
CODE	CDR2020	CDR2020H
INTERIOR DIMENSIONS	20 $\frac{7}{8}$ " x 20 $\frac{7}{8}$ " (53 x 53 cm)	20 $\frac{7}{8}$ " x 20 $\frac{7}{8}$ " (53 x 53 cm)
EXTERIOR DIMENSIONS	21 $\frac{3}{8}$ " x 21 $\frac{3}{8}$ " x 8" (54,5 x 54,5 x 20,5 cm)	21 $\frac{3}{8}$ " x 23 $\frac{3}{8}$ " x 37" (54,5 x 59,5 x 94 cm)
LOAD CAPACITY	350 lbs. (159 kg)	350 lbs. (159 kg)
CASE LBS. (CUBE)	11.75 (1.14)	21.50 (3.25)
CASE KG (CUBE M³)	5,3 (0,03)	9,7 (0,1)
LIST PRICE EACH	\$ 170.00	\$ 275.00

Case Pack: 1 Casters: 3 $\frac{1}{2}$ " (10 cm) casters, 4 swivel, no brakes.
InStock Color: Soft Gray (151).

Camrack IceExpress Glass Filler

- Dramatically reduces banquet set-up time.
- Fills 25 glasses with ice all at once.
- Reduces breakage and risk of contamination.
- Ice falls directly into glasses with no spills or drips.

CODE	EXTERIOR DIMENSIONS W x D x H	CASE WEIGHT (CUBE)	LIST PRICE EA.
25SWG	20" x 20 $\frac{1}{8}$ " x 1 $\frac{1}{4}$ " (50,8 x 50,8 x 3,18 cm)	2.5 lbs. (0.49 ft ³) 1,13 kg (0,014 m ³)	\$ 83.25

Case Pack: 1 Color: Black (110).



Selecting The Right Camrack

Selecting the Right Camrack

Cambro offers multiple ways to help you quickly find the right Camrack:

1. www.cambro.com/mycamracks

To quickly find the correct Camrack, please visit www.cambro.com/mycamracks. Select the item your are sizing, enter the measurements and quantity of the item, and the right Camrack will appear on the page.

2. Cambro Catalog

Flip to the back of this section for a convenient stemware and glass sizing reference guide.

3. Cambro Sales Representatives

Contact your local Cambro representative to assist with specifying Camracks, dollies and covers that will fit your glasses and dishware. To find your local representative, refer to the back section of this catalog, visit www.cambro.com or call Cambro Customer Service at 800 833 3003.

4. Send a Sample to Cambro

Send a sample glass to:
CAMBRO
Customer Service Department
5801 Skylab Road
Huntington Beach, CA 92647
Please be sure to include complete contact information and specify if you need full-size or half-size Camracks.

Choose the correct Camrack:

1. Measure the **maximum diameter** of the glass (stemware or tumbler) to determine the number of compartments.
2. Measure the **maximum height** of the glass (stemware or tumbler) to the top edge of the rim to determine the compartment height.

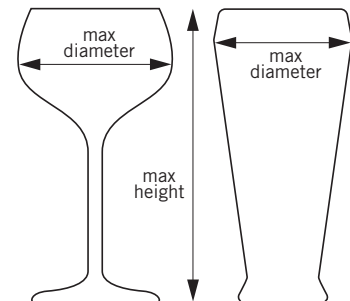

Stemware and Glass Sizing Reference Guide

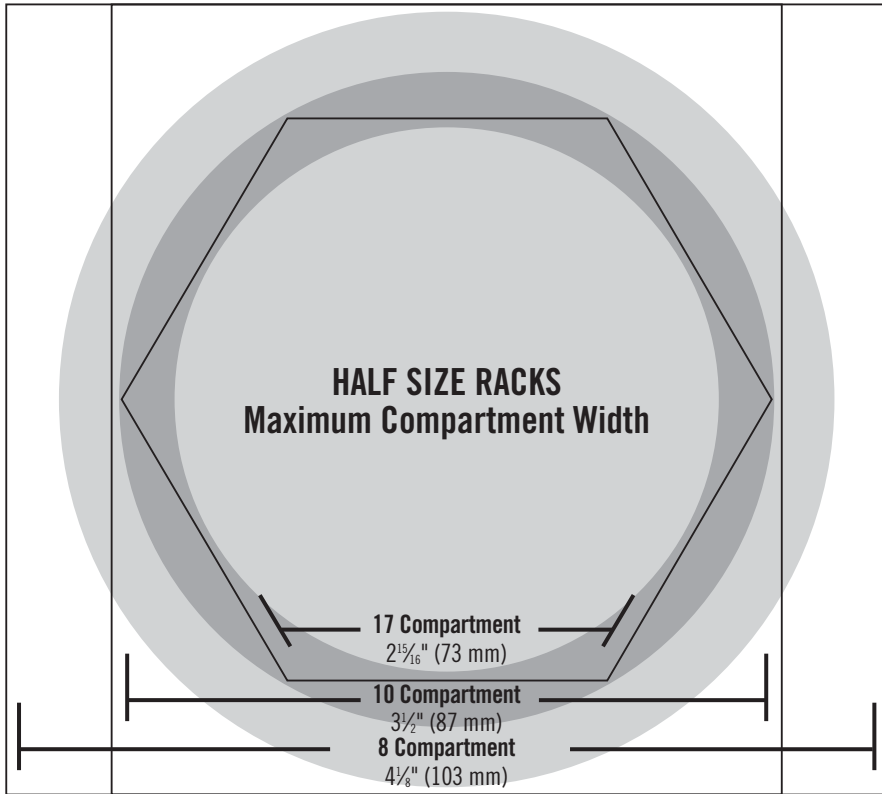

To Determine Compartment Size

- Half Size Racks:** Place glass or stemware upside down over circle chart. Look down on the glass. Whatever circle the largest diameter of the glass fits within will determine the number of compartments.
- Full Size Racks:** Place glass or stemware upside down over circle chart. Look down on the glass. Whatever circle the largest diameter of the glass fits within will determine the number of compartments.

Use the vertical guide marks at right to determine item height and appropriate rack number. 

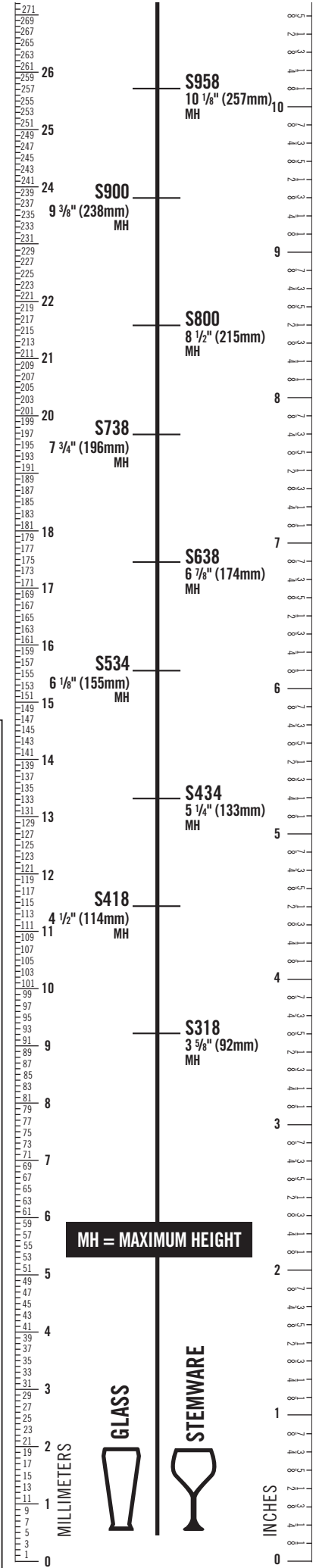
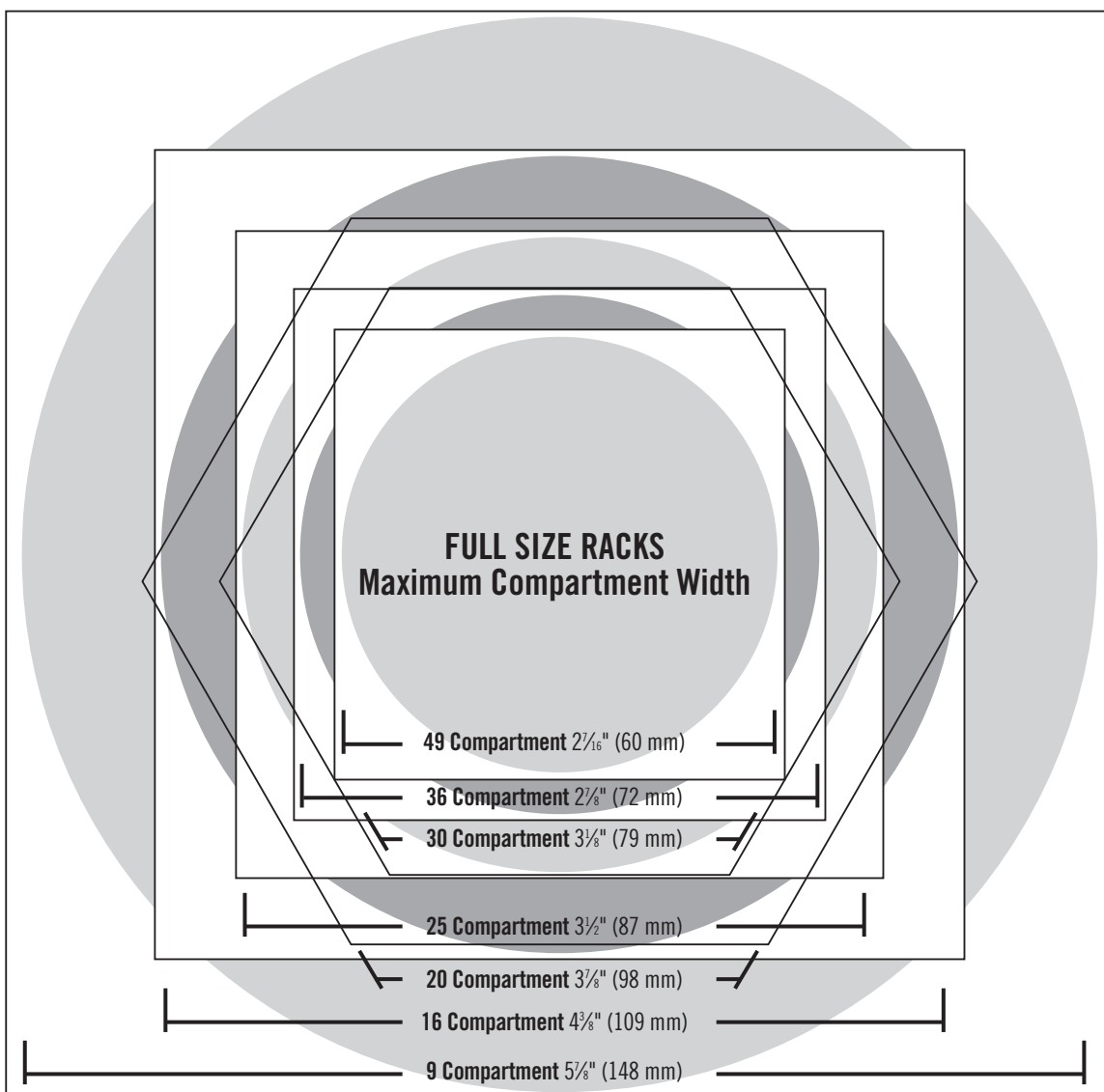

Camrack® Cup Rack Reference Guide



16

FULL RACK

COMPARTMENT

4³/₈" x 4³/₈" (11,1 x 11,1 cm)

QUICK GUIDE

Full Size Cup Racks (C)

Maximum Cup Width	Number of Compartments	Maximum Cup Height		
		2 ⁵ / ₈ " (6,6 cm)	4 ¹ / ₄ " (10,7 cm)	5 ⁷ / ₈ " (14,9 cm)
4 ³ / ₈ " (11,1 cm)	16	16C258	16C414	16C578
3 ¹ / ₂ " (8,8 cm)	20	20C258	20C414	NA

To determine Cup compartment size:

Turn cup or coffee mug upside down and place diagonally in square. Align handle with arrow in square. Cup or mug and handle must fit completely within boundaries of a square in order to ensure the right rack.



20

FULL RACK

COMPARTMENT

4³/₈" x 3¹/₂" (11,1 x 8 cm)



10

HALF RACK

COMPARTMENT

4¹/₈" x 3¹/₂" (10,4 x 8,8 cm)



8

HALF RACK

COMPARTMENT

4⁷/₁₆" x 4¹/₈" (11,3 x 10,4 cm)

QUICK GUIDE

Half Size Cup Racks (HC)

Maximum Cup Width	Number of Compartments	Maximum Cup Height	
		2 ⁵ / ₈ " (6,6 cm)	4 ¹ / ₄ " (10,7 cm)
4 ¹ / ₈ " (10,4 cm)	8	8HC258	8HC414
3 ¹ / ₂ " (8,8 cm)	10	10HC258	10HC414

To Determine Cup Height:

Place base of cup or coffee mug on flat surface hold ruler vertically next to it to determine height in inches or millimeters. If the height is greater than 4¹/₄" (108 mm), additional 1⁵/₈" (41 mm) E2 and HE2 extenders may be ordered.

Camdollies®

- Use to transport anything from stacks of sheet pans to catering equipment.
- Reduce employee lifting and carrying and possible injury.
- Made of extremely durable plastic that will not dent, crack, rust or corrode.
- Heavy-duty casters maneuver easily over all types of terrain.
- For heavy transport needs, select models with handles and Rear Big Wheels.

Colors: Coffee Beige (157), Dark Brown (131), Black (110), Slate Blue (401), Gray (180).
CDR2020, CDR2020H Color: Soft Gray (151).

Caster Type
A: 5" Casters: 2 fixed, 2 swivel, 1 with brake.
B: 3" Casters: 4 swivel, no brakes.
C: 10" Rear Big Wheels, 2 front 5" swivel casters, 1 with brake.
D: 3½" Casters: 4 swivel, no brakes.

Camdollies Case Pack: 1

For Dish Racks

EXTERNAL DIM. W x D x H 21½" x 21¾" x 8"
INTERIOR DIM. W x D 20⅞" x 20⅞"
CASE LBS. (CUBE) 11.75 (1.14)
LIST PRICE EACH \$ 170.00

350 Lbs. CAPACITY	D CASTER TYPE
-----------------------------	-------------------------



CDR2020
InStock Color: Soft Gray (151)

EXTERNAL DIM. W x D x H 21½" x 23¾" x 37"
INTERIOR DIM. W x D 20⅞" x 20⅞"
CASE LBS. (CUBE) 21.5 (3.25)
LIST PRICE EACH \$ 275.00

350 Lbs. CAPACITY	D CASTER TYPE
-----------------------------	-------------------------



CDR2020H
(with powder coated handle)

For 18" x 26" Trays and Sheet Pans

EXTERNAL DIM. W x D x H 20⅞" x 31½" x 38½"
INTERIOR DIM. W x D 18½" x 26⅞"
CASE LBS. (CUBE) 33.75 (12.82)
LIST PRICE EACH \$ 510.00

Holds: UPC101

300 Lbs. CAPACITY	A CASTER TYPE
-----------------------------	-------------------------

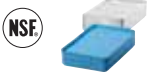

CD1826H

EXTERNAL DIM. W x D x H 22½" x 22½" x 8⅞"
INTERIOR DIM. W x D 20⅞" x 20⅞"
CASE LBS. (CUBE) 16.82 (2.68)
LIST PRICE EACH \$ 280.00

300 Lbs. CAPACITY	B CASTER TYPE
-----------------------------	-------------------------



CD2020

EXTERNAL DIM. W x D x H 23¾" x 33½" x 36½"
INTERIOR DIM. W x D 18½" x 26⅞"
CASE LBS. (CUBE) 47 (18.29)
LIST PRICE EACH \$ 635.00

Holds: UPC101

300 Lbs. CAPACITY	C CASTER TYPE
-----------------------------	-------------------------

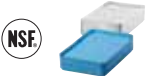

CD1826HB

EXTERNAL DIM. W x D x H 22¾" x 24¾" x 36¾"
INTERIOR DIM. W x D 20⅞" x 20⅞"
CASE LBS. (CUBE) 32.25 (11.45)
LIST PRICE EACH \$ 440.00

350 Lbs. CAPACITY	B CASTER TYPE
-----------------------------	-------------------------



CD2020H

EXTERNAL DIM. W x D x H 26" x 26⅞" x 36⅞"
INTERIOR DIM. W x D 20½" x 20⅞"
CASE LBS. (CUBE) 46 (15.89)
LIST PRICE EACH \$ 570.00

350 Lbs. CAPACITY	C CASTER TYPE
-----------------------------	-------------------------



CD2020HB

Camdollies®

For Milk Crates and #10 Can Cases

EXTERNAL DIM. W x D x H 16¼" x 21¼" x 8⅝"
INTERIOR DIM. W x D 13⅞" x 19⅝"
CASE LBS. (CUBE) 15.25 (1.44)
LIST PRICE EACH \$ 275.00

Holds: 14" x 19" Milk Crates and #10 Can Cases



CD1420

350 Lbs. CAPACITY	B CASTER TYPE
-----------------------------	-------------------------



Utility Trucks

- Use for transporting loads of up to 600 lbs.
- Large platforms for convenient loading and built-in handles for easy maneuvering.
- All models feature 5" (12,7 cm) heavy-duty casters bolted into molded-in metal backing plates.

Colors: Coffee Beige (157), Dark Brown (131), Black (110), Slate Blue (401), Gray (180), Brick Red (402), Kentucky Green (519).

Casters: 5", 2 fixed, 2 swivel, 1 with brake.

Utility Trucks Case Pack: 1



EXTERNAL DIM. W x D x H 21⅝" x 30¼" x 8"
INTERIOR DIM. W x D 19⅞" x 27⅞"
CASE LBS. (CUBE) 18.8 (3.28)
LIST PRICE EACH \$ 290.00

Holds: 14" x 19" Milk Crates, #10 Can Cases and UPC101



CD2028

350 Lbs. CAPACITY	B CASTER TYPE
-----------------------------	-------------------------



EXTERNAL DIM. W x D x H 19¾" x 32⅝" x 38½"
LOAD PLATFORM 19¾" x 29⅝"
CASE LBS. (CUBE) 31 (3.29)
LIST PRICE EACH \$ 695.00

600 Lbs.
CAPACITY



2030UT
(With chrome handle)
45155
200" Long Strap

EXTERNAL DIM. W x D x H 16⅞" x 16⅞" x 8⅞"
INTERIOR DIM. W x D 13⅞" x 13⅞"
CASE LBS. (CUBE) 12.3 (1.11)
LIST PRICE EACH \$ 255.00

Holds: 13" x 13" Milk Crates



CD1313

250 Lbs. CAPACITY	B CASTER TYPE
-----------------------------	-------------------------



EXTERNAL DIM. W x D x H 23¾" x 41⅞" x 36¼"
LOAD PLATFORM 23¾" x 35⅞"
CASE LBS. (CUBE) 45 (22.93)
LIST PRICE EACH \$ 650.00

600 Lbs.
CAPACITY



2436UTH
45155
200" Long Strap

EXTERNAL DIM. W x D x H 16⅞" x 29¼" x 8⅞"
INTERIOR DIM. W x D 13⅞" x 26¼"
CASE LBS. (CUBE) 14.97 (2.54)
LIST PRICE EACH \$ 275.00

Holds: 13" x 13" Milk Crates and #10 Can Cases



CD1327

300 Lbs. CAPACITY	B CASTER TYPE
-----------------------------	-------------------------



EXTERNAL DIM. W x D x H 23¾" x 41⅞" x 36¼"
LOAD PLATFORM 23¾" x 35⅞"
CASE LBS. (CUBE) 46 (22.93)
LIST PRICE EACH \$ 695.00

600 Lbs.
CAPACITY



2436UTHS
(Includes two straps)

Tray & Dish Cart / Tray & Silver Cart

Tray & Dish Cart

- Open storage compartment holds a wide variety of plates and trays.
- Use with or without detachable cutlery station.
- Made of easy-to-clean polyethylene that won't rust, peel or corrode.
- Rounded, molded-in corners protect furniture and walls.
- Molded-in handles and heavy-duty 6" (15,2 cm) swivel casters ease maneuvering.

Colors: Slate Blue (401), Coffee Beige (157), Dark Brown (131), Gray (180), Granite Gray (191), Granite Green (192), Black (110).

6" Casters: All swivel, 2 with brake.

Vinyl cover is not NSF listed.



Flatware cylinders and vinyl cover included with TDCR12.

TDCR12

CODE	DESCRIPTION	CASE LBS. (CUBE)	LIST PRICE EA.
TDCR12	Cart & Rack Combination	88.9 (22.24)	\$ 1,325.00
TDC2029*	Cart only	62 (18.14)	1,005.00
CR12	Cutlery Rack only	23.5 (4.46)	285.00
FWC56	Flatware Cylinder	2.73 (0.41)	4.40

Case Pack: 1 FWC56 Case Pack: 12

CODE	DESCRIPTION	L x W x H
TDCR12	Cart & Rack Combination	38 $\frac{3}{8}$ " x 22 $\frac{3}{4}$ " x 41 $\frac{1}{4}$ "
TDC2029*	Cart	38 $\frac{3}{8}$ " x 22 $\frac{3}{4}$ " x 34 $\frac{1}{4}$ "
CR12	Cutlery Rack	33" x 22 $\frac{3}{4}$ " x 9"

*TDC2029 is not available in Black (110).

Tray & Silver Cart

- Use to neatly organize trays and accessories for self-service.
- Includes eight clear Camwear® food pans to hold flatware, napkins and non-perishable condiments.
- Protective vinyl cover included.

Colors: Slate Blue (401), Coffee Beige (157), Dark Brown (131), Gray (180), Granite Gray (191), Granite Green (192).

6" Casters: All swivel, 2 with brake.

Vinyl cover is not NSF listed.



TC1418

CODE	DESCRIPTION	CASE LBS. (CUBE)	LIST PRICE EA.
TC1418	Cart w/Pans & Vinyl Cover	84 (19.46)	\$ 1,130.00

Case Pack: 1

CODE	EXTERIOR DIMENSIONS L x W x H	WEIGHT CAPACITY	MAXIMUM TRAY SIZE	TRAY CAPACITY
TC1418	32 $\frac{3}{8}$ " x 21 $\frac{1}{4}$ " x 45 $\frac{1}{2}$ "	500 lbs.	14" x 18"	180-200 in two stacks

CAMWEAR® PANS FOR SELF-SERVE TOP:

PAN QUANTITY, SIZE	CAPACITY
4 each, 1/2 size x 4" deep	Holds 100 knives, 100 spoons, 80 forks
4 each, 1/2 size x 4" deep	Holds variety of condiments



Vinyl cover included for sanitary storage.



S-Series Adjustable Dish Caddy

- Store one size dish or a combination of different sizes in a single caddy.
- Features easy-to-adjust column towers.

ADCS Colors: Black (110), Slate Blue (401), Speckled Gray (480), Dark Brown (131).

Casters: 5", 2 swivel with brakes and two 10" Easy wheels.

Vinyl cover included. Not NSF listed.

For square and rectangular plates, please contact Cambro for suggested use.



Holds plates and bowls from 4⁵/₈" to 13"

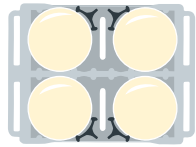

Plate sizes: 9¹/₄" to 13" diam.
4 Columns (60 each)
Total Capacity: 240

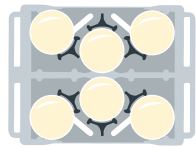

Plate sizes: 7¹/₄" to 9" diam.
6 Columns (60 each)
Total Capacity: 360

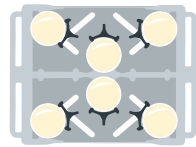
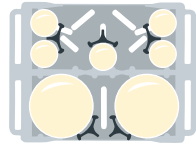
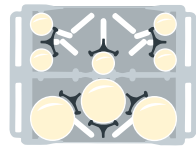

Plate sizes: 5³/₄" to 7" diam.
6 Columns (45 each)
Total Capacity: 270



2 Columns: 9¹/₄" to 13" diam. (60 each)
5 Columns: 4³/₄" (45 each)
Total Capacity: 345



3 Columns: 7¹/₄" to 9" diam. (60 each)
5 Columns: 4³/₄" (45 each)
Total Capacity: 405

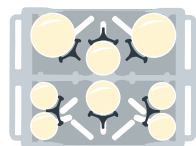

2 Columns: 7¹/₄" to 9" diam. (60 each)
2 Columns: 5³/₄" to 7" (45 each)
4 Columns: 4³/₄" (45 each)
Total Capacity: 390

1.800.833.3003

STABLE & SECURE

1/2" (1,27 cm) rod from top to bottom of divider

ADCS OVERALL DIMENSIONS

W 28⁵/₈" x L 37⁷/₈" x H 31¹/₈"
(73 x 96 x 81 cm)

EASY TO MANEUVER

Ergonomic molded-in handles on both ends

HOLDING CAPACITY

Six 19¹/₂" (49,5 cm) storage columns hold 45-60 plates per stack

EXTREMELY DURABLE

Heavy duty polyethylene construction protects china from chipping. Won't chip, crack or rust

REAR WHEELS

10" (25,4 cm) non-marking Easy Wheels

FRONT CASTERS

5" (12,7 cm) swivel with brake



A 3/4" (2 cm) plated steel rear axle allows for 500 lbs. (227 kg) load capacity.



Vinyl cover included with every dolly for sanitary storage.

CODE

NUMBER OF DIVIDERS

ADCS

6

PLATES PER COLUMN

Approximately 45-60

OVERALL DIMENSIONS W x L x H

28⁵/₈" x 37⁷/₈" x 31¹/₈"

CASE LBS. (CUBE)

133.8 (22.01)

LIST PRICE EACH

\$ 1,285.00

Case Pack: 1

Colors: Black (110), Speckled Gray (480).

Plate & Bowl size range from 4³/₄" to 13"

Versa Dish Caddies, Dish Caddies, Adjustable Tray & Dish Cart



Versa Dish Caddies

- Secure, high-capacity storage to protect both square and round plates.
- Durable, polyethylene exterior will not rust, crack, dent or chip.
- Poker chip style offers greater access for easy plate removal.
- A ¾" (2 cm) plated steel rear axle allows for 500 lbs. (227 kg) load capacity.
- Molded-in handles on both ends for easy transporting.

- Five-inch (12,7 cm) front swivel casters with brake and 10" (25,4 cm) non-marking rear wheels ease maneuvering.
- No assembly required.

Colors: Black (110), Slate Blue (401), Dark Brown (131), Speckled Gray (480).

Casters: 2, 5" swivel with brakes and two 10" Easy Wheels.

Vinyl cover included. Not NSF listed.

DCS950 is covered by U.S. Patent D 603,120 S. DCS1125 is covered by U.S. Patent D 625,894.



DCS950 holds 5 columns of 45-60 round plates up to 9½" (24,1 cm) or 4 to 5 columns of square plates up to 8" (20,5 cm).

DCS1125 holds 4 columns of 45-60 round plates up to 11¼" (28,6 cm) or square plates up to 9½" (24,1 cm).

Poker Chip Style Dish Caddies

- Use to store and protect valuable dishware.
- Dividers are molded into the body in a standard poker chip design.
- Made of durable polyethylene that protects plates from chipping.
- Open access from two sides for easy loading and unloading.
- Rounded corners inside and out protect dishware, furniture and walls.

Colors: Black (110), Slate Blue (401), Dark Brown (131), Granite Gray (191).

Casters: 2, 5" swivel with brakes and two 10" Easy Wheels.

Vinyl cover included. Not NSF listed.



DC700



Sanitary plastic cover included and recommended for protecting clean dinnerware & trays. Replacement covers are available through the Cambro Replacement Parts List at www.cambro.com.

Adjustable Tray & Dish Cart

- Use to store a wide variety of plates and trays.
- Move two adjustable dividers into position easily to secure trays and plates.
- Made of durable polyethylene that cushions plates and trays to prevent chipping.
- Easy to clean and won't dent, rust, chip or break.

Colors: Black (110), Slate Blue (401), Coffee Beige (157), Dark Brown (131), Gray (180), Granite Gray (191), Granite Green (192).

Casters: 6", all swivel, 2 with brake.

Maximum load capacity: 500 lbs.

Vinyl cover included. Not NSF listed.



TDC30



Sanitary plastic cover included.

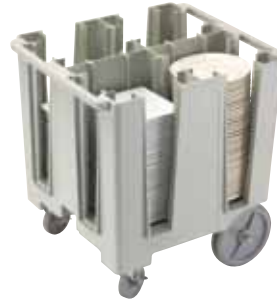
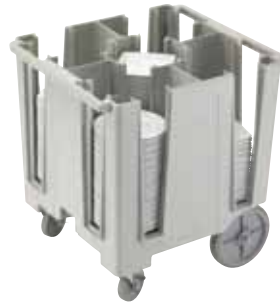

Versa Dish Caddies

CODE	DCS950	DCS1125
PLATE SIZE RANGE (ROUNDS)	8 $\frac{3}{8}$ " - 9 $\frac{1}{2}$ " (21,3 - 24,1 cm)	9 $\frac{5}{8}$ " - 11 $\frac{1}{4}$ " (24,4 - 28,6 cm)
PLATE SIZE RANGE (SQUARES)	7 $\frac{1}{4}$ " - 8" (18,4 - 20,5 cm)	8 $\frac{3}{8}$ " - 9 $\frac{1}{2}$ " (21,3 - 24,1 cm)
COLUMNS PER CADDY	5, 45-60 plates per col.	4, 45-60 plates per col.
OVERALL DIMENSIONS W x L x H	27" x 30 $\frac{1}{2}$ " x 31 $\frac{3}{4}$ "	27" x 30 $\frac{1}{2}$ " x 31 $\frac{3}{4}$ "
CASE LBS. (CUBE)	89.5 (16.64)	89 (16.64)
LIST PRICE EACH	\$ 1,010 .00	\$ 1,055.00

Case Pack: 1 InStock Colors: Black (110), Speckled Gray (480).

Sanitary plastic cover included with all Cambro dish caddies.



Poker Chip Style Dish Caddies

CODE	DC575	DC700	DC825
PLATE SIZE RANGE	up to 5 $\frac{3}{4}$ " (14,6 cm)	5 $\frac{5}{8}$ " - 7" (14,9 - 17,8 cm)	7 $\frac{1}{8}$ " - 8 $\frac{1}{4}$ " (18,1 - 21 cm)
COLUMNS PER CADDY	6, 45-60 plates per col.	6, 45-60 plates per col.	4, 45-60 plates per col.
OVERALL DIMENSIONS W x L x H	32 $\frac{5}{8}$ " x 23 $\frac{1}{2}$ " x 31 $\frac{3}{4}$ "	32 $\frac{5}{8}$ " x 23 $\frac{1}{2}$ " x 31 $\frac{3}{4}$ "	28 $\frac{3}{4}$ " x 23 $\frac{3}{4}$ " x 32"
CASE LBS. (CUBE)	64 (14.59)	64 (14.59)	58 (12.82)
LIST PRICE EACH	\$ 1,010.00	\$ 1,010.00	\$ 1,010.00

Case Pack: 1



Poker Chip Style Dish Caddies

CODE	DC1225
PLATE SIZE RANGE	11 $\frac{1}{8}$ " - 12 $\frac{1}{4}$ " (28,9 - 31,1 cm)
COLUMNS PER CADDY	4, 45-60 plates per col.
OVERALL DIMENSIONS W x L x H	32 $\frac{3}{4}$ " x 27 $\frac{1}{2}$ " x 32"
CASE LBS. (CUBE)	71 (17.78)
LIST PRICE EACH	\$ 1,075.00

Case Pack: 1



Adjustable Tray & Dish Cart

CODE	TDC30
NUMBER OF DIVIDERS	2
PLATES PER COLUMN	Approximately 45-60
TRAYS PER COLUMN	80 Trays: 14" x 18"
OVERALL DIMENSIONS W x L x H	23 $\frac{1}{4}$ " x 38 $\frac{3}{8}$ " x 34 $\frac{1}{2}$ "
CASE LBS. (CUBE)	76.67 (18.74)
LIST PRICE EACH	\$ 1,320.00

Case Pack: 1

Cambox® Bus Boxes



Regal



CODE	1120CBR	1520CBR
DESCRIPTION	Four Compartment Cutlery Box	15" x 20" Cambox
DIM. W x L x H	11 ³ / ₈ " x 20 ⁷ / ₁₆ " x 3 ³ / ₄ "	15 ⁵ / ₁₆ " x 19 ¹⁵ / ₁₆ " x 4 ¹⁵ / ₁₆ "
CASE LBS. (CUBE)	22.54 (2.65)	23 (3.54)
LIST PRICE EACH	\$ 24.05	\$ 24.60

Case Pack: 12 Colors: Black (110), Dark Brown (131).



CODE	1621CBR	21155CBR	21157CBR	1722CBR
DESCRIPTION	16" x 21" Cambox	15" x 21" x 5" Cambox	15" x 21" x 7" Cambox	17" x 22" Cambox
DIM. W x L x H	15 ⁵ / ₈ " x 20 ¹ / ₂ " x 4 ⁷ / ₈ "	15 ¹ / ₄ " x 20 ¹ / ₄ " x 4 ¹⁵ / ₁₆ " (includes handle)	15 ⁵ / ₁₆ " x 20 ³ / ₁₆ " x 6 ¹⁵ / ₁₆ "	16 ⁷ / ₈ " x 21 ⁷ / ₈ " x 4 ³ / ₄ "
CASE LBS. (CUBE)	42 (3.99)	27.74 (3.94)	35.20 (4.53)	28.24 (4.15)
LIST PRICE EACH	\$ 39.50	\$ 28.85	\$ 33.25	\$ 31.95

Case Pack: 12 Colors: Black (110), Dark Brown (131).

Poly



CODE	415CBP	912CBP	1120CBP	1520CBP	1520CBPF*
DESCRIPTION	Cutlery Box	Utility Box	11" x 20" Cambox	15" x 20" Cambox	15" x 20" Cambox
DIM. W x L x H	4 ¹ / ₁₆ " x 14 ³ / ₁₆ " x 4 ¹ / ₈ "	9 ¹ / ₁₆ " x 12 ¹ / ₁₆ " x 5 ¹ / ₈ "	11 ³ / ₈ " x 20 ⁷ / ₁₆ " x 3 ³ / ₄ "	15 ⁵ / ₁₆ " x 19 ¹⁵ / ₁₆ " x 4 ¹⁵ / ₁₆ "	15 ⁵ / ₁₆ " x 19 ¹⁵ / ₁₆ " x 4 ¹⁵ / ₁₆ "
CASE LBS. (CUBE)	2.6 (0.75)	9.25 (1.22)	20.5 (2.59)	18.61 (3.29)	20.5 (3.54)
LIST PRICE EACH	\$ 8.00	\$ 10.85	\$ 17.35	\$ 17.90	\$ 17.90

Case Pack: 12 Colors: Black (110), Dark Brown (131), Light Gray (180). InStock Color: Light Gray (180). *1520CBPF is identical to 1520CBP except the internal surface is flat.



CODE	1621CBP	21155CBP	21157CBP	1722CBP
DESCRIPTION	15" x 20" Cambox	15" x 21" x 5" Cambox	15" x 21" x 7" Cambox	17" x 22" Cambox
DIM. W x L x H	15 ⁵ / ₈ " x 20 ¹ / ₂ " x 4 ⁷ / ₈ "	15 ¹ / ₄ " x 20 ¹ / ₄ " x 4 ¹⁵ / ₁₆ " (includes handle)	15 ⁵ / ₁₆ " x 20 ³ / ₁₆ " x 6 ¹⁵ / ₁₆ "	16 ⁷ / ₈ " x 21 ⁷ / ₈ " x 4 ³ / ₄ "
CASE LBS. (CUBE)	31.20 (3.89)	21.41 (3.20)	25 (3.73)	26 (4.20)
LIST PRICE EACH	\$ 27.05	\$ 20.15	\$ 21.75	\$ 21.75

Case Pack: 12 Colors: Black (110), Dark Brown (131), Light Gray (180). InStock Color: Light Gray (180).

Covers



CODE	1520CBCP	1722CBCP	2115CBCP	2115CBR
FITS	1520CBP, 1520CBPF 15 x 20 Cambox, Poly	1722CBR, 1722CBP 17 x 22 Cambox, Regal & Poly	21155CBP, 21157CBP 15 x 20 Cambox, Poly	21155CBR, 21157CBR 15 x 20 Cambox, Regal
DIM. W x L	16" x 20 ¹ / ₂ "	17 ¹ / ₁₆ " x 22 ³ / ₈ "	15 ¹ / ₂ " x 20 ¹ / ₂ "	15 ¹ / ₂ " x 20 ¹ / ₂ "
CASE LBS. (CUBE)	13.08 (1.17)	13.36 (0.93)	12.75 (1.38)	17 (1.40)
LIST PRICE EACH	\$ 14.50	\$ 26.15	\$ 14.45	\$ 15.00

Case Pack: 12 Color: White (148).



KD Service Cart and KD Utility Cart

- Versatile, durable and economically-priced carts.
- Marine rails and lightly-textured polypropylene shelves keep contents in place.
- Aluminum uprights ensure stability.
- Ships “knocked down” to minimize shipping costs.
- Easy to assemble.

Cart and Shelf Panel Set Colors:
Black (110), Speckled Gray (480).

Trash Container and Silverware Holder Color: Black (110).



Each BC340KD shelf holds one full-sized dish rack or two standard bus boxes

Optional shelf panels can be added at time of assembly to enclose three sides

Marine rails keep contents in place

Sturdy aluminum uprights

Four powder coated steel swivel casters provide quiet transport and steady maneuvering

Durable, stain-resistant surface is easy to clean



BC340KD



CODE	BC340KD	BC331KD
DESCRIPTION	Utility Cart	Service Cart
CASTER DIA./TYPE	5", 4 swivel, no brake	4", 4 swivel, no brake
OVERALL DIM. L x D x H	40" x 21¼" x 37½"	32⅞" x 16¼" x 38"
SHELF DIM. L x D x H	31½" x 20½" x 11¼"	24⅜" x 15⅞" x 11¼"
LOAD CAPACITY	400 lbs.	300 lbs.
CASE LBS. (CUBE)	39 (6.72)	24.01 (4.07)
LIST PRICE EACH	\$ 292.00	\$ 196.00

Case Pack: 1 InStock Colors: Black (110), Speckled Gray (480).



BC331KD

Optional Accessories



CODE	BC331KDTC	BC331KDSH	BC340KDP
DESCRIPTION	8 gal. Trash Container	2.5 gal. Silverware Holder	Single Shelf Panel Set (for KD Utility Cart only)
DIM. W x D x H	13" x 9½" x 22"	13" x 9½" x 7¼"	31⅞" x 17¼" x 11¼"
CASE LBS. (CUBE)	4.96 (1.92)	2.25 (0.59)	6.25 (0.65)
LIST PRICE EACH	\$ 80.00	\$ 46.00	\$ 80.00

Case Pack: 1

Service Carts



- All-purpose versatile, durable and dependable workhorses.
- Ideal for use on the receiving dock or setting up and bussing tables.
- Made of one-piece, polyethylene with molded-in handles and shelves.
- Choose from models with open or enclosed sides.

Colors: Black (110), Slate Blue (401), Dark Brown (131), Coffee Beige (157), Gray (180), Granite Gray (191), Granite Green (192).

BC225, BC2254S, BC11TC and BC1115SH can be shipped by parcel carrier.



Open Carts



CODE	BC225	BC2254S	BC235
CASTER DIA./TYPE	3", 2 fixed, 2 swivel, 1 w/brake	3", 4 swivel, 1 w/brake	5", 2 fixed, 2 swivel, 1 w/brake
OVERALL DIM. L x D x H	28" x 16" x 32 1/4"	28" x 16" x 32 1/4"	37 1/4" x 21 1/2" x 34 5/8"
SHELF DIM. L x D x H	21 1/4" x 15 1/2" x 11 1/4"	21 1/4" x 15 1/2" x 11 1/4"	31 1/2" x 20 3/8" x 11 3/8"
LOAD CAPACITY	350 lbs.	350 lbs.	500 lbs.
CASE LBS. (CUBE)	41 (9.2)	38.8 (9.2)	63.33 (17.63)
LIST PRICE EACH	\$ 560.00	\$ 580.00	\$ 770.00

Case Pack: 1



CODE	BC2354S	BC230	BC2304S
CASTER DIA./TYPE	5", 4 swivel, 1 w/brake	5", 2 fixed, 2 swivel, 1 w/brake	5", 4 swivel, 1 w/brake
OVERALL DIM. L x D x H	37 1/4" x 21 1/2" x 34 5/8"	33 3/4" x 20" x 34 5/8"	33 3/4" x 20" x 34 5/8"
SHELF DIM. L x D x H	31 1/2" x 20 3/8" x 11 3/8"	27" x 19 1/2" x 11 1/4"	27" x 19 1/2" x 11 1/4"
LOAD CAPACITY	500 lbs.	500 lbs.	500 lbs.
CASE LBS. (CUBE)	68 (17.85)	62 (15.13)	57.4 (14.77)
LIST PRICE EACH	\$ 780.00	\$ 710.00	\$ 720.00

Case Pack: 1

Enclosed Carts



CODE	BC330	BC3304S
CASTER DIA./TYPE	5", 2 fixed, 2 swivel, 1 w/brake	5", 4 swivel, 1 w/brake
OVERALL DIM. L x D x H	33 3/8" x 20" x 34 3/8"	33 3/8" x 20" x 34 3/8"
SHELF DIM. L x D x H	27" x 18 1/2" x 11 1/4"	27" x 18 1/2" x 11 1/4"
LOAD CAPACITY	500 lbs.	500 lbs.
CASE LBS. (CUBE)	64.17 (14.73)	65.2 (14.87)
LIST PRICE EACH	\$ 765.00	\$ 775.00

Case Pack: 1

Optional Accessories



CODE	BC11TC*	BC1115SH*
DESCRIPTION	11 gal. Trash Container	1.75 gal. Silverware Holder
DIMENSIONS W x D x H	13 3/4" x 8 7/8" x 21 1/8"	14 1/2" x 6" x 5 3/8"
CASE LBS. (CUBE)	6 (2.1)	3.25 (0.79)
LIST PRICE EACH	\$ 85.00	\$ 75.00

Case Pack: 1 * BC11TC & BC1115SH will not fit KD Service or Utility Carts. BC11TC & BC1115SH are available in Black (110) and Dark Brown (131) only.

Alpha Numerical Listing

Discontinued items effective 1/1/2013

CODE	PAGE	PRICE	CODE	PAGE	PRICE	CODE	PAGE	PRICE
1000 (Group 3)	12	16.80	10HS1114	189	104.70	1220D (Group 3)	13	29.70
1000CW	33	11.65	10HS318	189	38.90	1222D (Group 1)	13	23.15
1000LCD	146	405.00	10HS434	189	53.20	1222D (Group 3)	13	29.65
1000LCDCVR	146	130.00	10HS638	189	64.25	1224MT	18	24.25
1000VT		Discontinued	10HS800	189	77.70	1227MT		Discontinued
1005CW	33	11.90	10HS958	189	91.30	1230MT	18	28.15
1007CW	33	11.90	10PPCH	117	11.95	124VS	32	20.35
100BC	134	40.00	10PPD	117	9.20	1252SLB250	106	350.20
100BC1	134	45.00	10PPSC	117	11.95	1252SLINB250	106	350.20
100BCS	134	60.00	10SC	111,115	11.10	12CW	109	21.35
100CW	31	2.80	1100 (Group 1)	12	12.95	12HP	113	50.70
100LCD	146,148	220.00	1100 (Group 3)	12	16.40	12HPH	114	58.25
100MCCW	120	13.70	1100CT	22	18.75	12RS12	134	196.00
100MPC	150	400.00	1101CW	33	11.90	12SFSCW	96	26.45
100MPCHL	149	500.00	1111SMVS	32	15.30	12SFSP	97	18.15
100VS	32	13.00	1111SQVS	32	15.30	12SFSP	97	19.05
1010VS	32	14.20	1116 (Group 1)	12	16.50	12TGS	54	5.90
1012VS	32	14.20	1116 (Group 3)	12	23.10	1300 (Group 1)	12	15.75
1013CW	33	11.95	1120CBP	208	17.35	1300 (Group 3)	12	20.80
1014 (Group 1)	11	15.25	1120CBR	208	24.05	1313 (Group 1)	13	15.75
1014 (Group 3)	11	19.70	1121TR (Group 1)		Discontinued	1313 (Group 3)	13	20.65
10145CW	26	14.95	1121TR (Group 3)		Discontinued	1318 (Group 1)	11	21.85
10146CW	24, 26	13.70	116VS	32	15.30	1318 (Group 3)	11	27.30
10146DCP	27	8.65	1200 (Group 1)	12	14.30	1318MT	18	19.85
10146DCPC	27	5.05	1200 (Group 3)	12	19.15	1318MTC	158	495.00
10146DCW	27	17.60	1200CW	41	2.50	1320TR (Group 1)		Discontinued
10146DCWC	27	9.35	1200DIV	133,161	75.00	1320TR (Group 3)		Discontinued
1014CL	16	13.85	1200P	40	1.51	13CLRCW	110	27.15
1014CT	22	23.10	1200P2	40	1.60	13CLRHP	114	61.30
1014FF	17	4.30	1202CW	33	11.95	1400 (Group 1)	12	16.05
1014VS	32	14.20	120CWP	31	8.40	1400 (Group 3)	12	21.75
1015 (Group 1)	12	15.75	120VS	32	19.60	1400CT	22	24.95
1015 (Group 3)	12	20.40	1210PW	161	190.60	1400TL	23	15.00
1015MT	18	15.50	1212SQVS	32	20.35	14105CP	26	6.65
10302MT	18	36.20	1216 (Group 1)	11	17.60	14105CW	26	15.00
1030MT	18	24.50	1216 (Group 3)	11	23.10	1411CP	28	6.10
103VS	32	13.40	1216CL	16	15.70	1411CW	28	17.50
105VS	32	13.40	1216CT	22	26.70	1418 (Group 1)	11	21.05
106VS	32	15.00	1216D (Group 1)	13	18.20	1418 (Group 3)	11	27.45
10CW	31	3.25	1216D (Group 3)	13	24.15	14187TRCW	26	26.90
10CWC	111	18.00	1216FF	17	5.10	1418CL	16	17.10
10CWCH	111	18.00	12183CW	104	24.10	1418CT	22	33.25
10CWCHN	111	18.00	12183P	105	18.60	1418CW	16	24.95
10CWD	109	15.50	12186CW	104	30.50	1418D (Group 1)	13	21.20
10CWGL	111,115	37.95	12186P	105	23.20	1418D (Group 3)	13	28.00
10CWL	31	2.50	12189CW	104	41.00	1418FF	17	6.55
10CWNR	31	6.90	12189P	105	30.65	1418TR (Group 1)	11	19.95
10HC258	190,194	26.20	1218CCW	104	14.90	1418TR (Group 3)	11	26.95
10HC414	190	43.45	1218CP	105	14.30	1418TRCW	16	24.95
10HE1	195	13.80	1218DSCW	105	9.70	1418VC	19,173	37.40
10HE2	195	12.95	1218MT	18	19.35	1418VDC	19,173	37.40
10HPC	115	45.50	1218SCCW	104	31.80	1422TR (Group 1)	11	21.85
10HPCH	115	45.50	1219D (Group 1)	13	21.40	1422TR (Group 3)	11	29.55
10HPCHN	115	45.55	1219D (Group 3)	13	27.60	14CW	109	27.15
10HPD	113	33.55	1220D (Group 1)	13	23.15	14HP	113	61.30

Alpha Numerical Listing

Discontinued items effective 1/1/2013

CODE	PAGE	PRICE
14PP	117	16.15
150CW	31	4.45
1520 (Group 1)	11	25.45
1520 (Group 3)	11	33.00
1520CBCP	208	14.50
1520CBP	208	17.90
1520CBPF	208	17.90
1520CBR	208	24.60
1520CL	16	19.55
1520CT	22	37.80
1520CW	16	25.95
1520D (Group 1)	13	25.20
1520D (Group 3)	13	31.85
1520TR (Group 1)	11	23.30
1520TR (Group 3)	11	30.45
1520VC	19,173	41.80
1520VCC	19	41.80
1520VCRST	19,173	44.00
1520VDC	19,173	41.80
1525RST	20	30.85
1550 (Group 1)	12	20.50
1550 (Group 3)	12	26.75
1550CT	22	33.90
1596CP	25	6.55
1596CW	25	12.05
15CLRCW	110	32.95
15CLRHP	114	79.70
1600 (Group 1)	12	20.15
1600 (Group 3)	12	26.95
1600CT	22	32.90
1600CW	41	3.10
1600DIV	130,161	75.00
1600P	40	1.79
1600P2	40	1.90
1600TL	23	20.00
1621CBP	208	27.05
1621CBR	208	39.50
1622 (Group 1)	11	29.30
1622 (Group 3)	11	38.10
16225 (Group 1)	11	32.10
16225 (Group 3)	11	40.10
1622CT	22	46.65
1622D (Group 1)	13	28.90
1622D (Group 3)	13	37.75
1622VC	19,173	51.70
16C258	190,194	36.70
16C414	190	51.15
16C578	190	76.40
16CW	109	32.95
16E1	194	16.45
16E2	194	14.60
16E4	195	17.65
16E5	195	15.55
16HP	113	79.70
16PP	117	20.65

CODE	PAGE	PRICE
16S1058	186	115.00
16S1114	186	131.90
16S1214	186	133.50
16S318	186	51.60
16S418	186	54.05
16S434	186	67.65
16S534	186	69.25
16S638	186	81.20
16S738	186	82.90
16S800	186	98.00
16S900	186	99.75
16S958	186	113.25
1722CBCP	208	26.15
1722CBP	208	21.75
1722CBR	208	31.95
17HE1	195	14.40
17HE2	195	13.80
17HS1114	189	113.25
17HS318	189	40.55
17HS434	189	55.40
17HS638	189	69.85
17HS800	189	84.60
17HS958	189	99.15
1800CT	22	46.65
1826 (Group 1)	11	39.05
1826 (Group 3)	11	50.25
182612CW	104	91.35
182612P	105	63.95
182615CW	104	107.80
182615P	105	75.25
18263CW	104	44.00
18263P	105	30.80
18266CW	104	57.00
18266P	105	40.45
18268CLRCW	105	81.55
18268CLRKIT	105	209.95
18269CW	104	75.00
18269P	105	52.75
1826CCW	104	29.85
1826CL	16	28.10
1826CLRCW	105	47.15
1826CP	105	23.75
1826CT	22	56.00
1826DBC	159	2,355.00
1826DBCSP	159	2,860.00
1826DSCW	105	24.55
1826DTC	159	2,355.00
1826DTCSP	159	2,880.00
1826LBC	158	1,410.00
1826LBCSP	158	1,625.00
1826LTC	158	1,425.00
1826LTC3	158	1,425.00
1826LTCSP	158	1,655.00
1826MT	18,51	31.65
1826MTC	158	740.00

CODE	PAGE	PRICE
1826SCCW	104	53.45
1826STP	153	90.00
1826STP	158	90.00
18CW	109	39.35
18SFSCW	96	39.25
18SFSP	97	24.55
18SFSP	97	25.90
1950 (Group 1)	12	27.80
1950 (Group 3)	12	36.65
1950CT	22	47.75
2000P	40	2.21
2000P2	40	2.41
200BC	134	55.00
200BC1	134	60.00
200BCS	134	70.00
200MCCW	120	18.90
2025 (Group 1)	11	47.60
2025 (Group 3)	11	57.95
2025MT	18	41.45
2030UT	202	695.00
20C258	190,194	38.05
20C414	190	52.35
20CC	40	2.61
20CFC	118	14.55
20CWC	111	9.40
20CWCH	111	9.40
20CWCHN	111	11.00
20CWWD	109	7.20
20CWGL	111,115	26.35
20CWL	111	14.85
20CWLN	111	14.85
20E2	194	13.55
20GE1	194	17.35
20GE2	194	15.05
20HPC	115	19.80
20HPCH	115	21.00
20HPCHN	115	24.10
20HPD	113	15.05
20HPL	115	34.85
20HPLN	115	34.85
20LPCWC	111	13.80
20LPCWD	109	8.05
20LPHPC	115	27.15
20LPHPD	113	16.75
20PPCH	117	8.20
20PPD	117	4.75
20PPSC	117	7.30
20S1114	187	131.90
20S318	187	51.60
20S434	187	68.50
20S638	187	81.95
20S800	187	98.00
20S958	187	113.25
20SC	111,115	6.45
21155CBP	208	20.15

Alpha Numerical Listing

Discontinued items effective 1/1/2013

CODE	PAGE	PRICE	CODE	PAGE	PRICE	CODE	PAGE	PRICE
21155CBR	208	28.85	26HP	113	42.10	34CW	109	12.25
21157CBP	208	21.75	26PP	117	12.55	34HP	113	27.40
21157CBR	208	33.25	2700 (Group 1)	12	44.35	34PP	117	8.00
2115CBCP	208	14.45	2700 (Group 3)	12	58.70	350LCD	146	225.00
2115CBCR	208	15.00	2700CT	22	66.85	35CLRCW	110	14.30
22CW	109	11.85	28CW	109	24.10	35CLRHP	114	37.25
22HP	113	25.25	2900CT	22	75.85	35CW	31	2.25
22LPCW	109	16.20	2SFSCW	96	8.55	36CF	118	43.25
22LPHP	113	36.05	2SFSP	97	6.35	36CW	109	14.30
22SFSCW	96	49.75	2SFSP	97	6.70	36E1	194	17.65
22SFSP	97	30.00	300DIV	161	75.00	36E2	195	15.90
22SFSP	97	31.90	300MPC	151	480.00	36E4	195	22.85
23CLRCW	110	14.75	3046 (Group 1)	13	18.70	36E5	195	17.65
23CLRHP	114	32.85	3046 (Group 3)	13	24.80	36HP	113	37.25
23SL	106	381.10	30CFC	118	12.15	36PP	117	9.25
23SLB250	106	705.55	30CWC	111	6.90	36S1058	188	127.65
23SLB6250	106	183.35	30CWCH	111	6.90	36S1114	188	131.90
23SLINB250	106	705.55	30CWCHN	111	9.40	36S1214	188	144.60
240MPC	149	280.00	30CWD	109	6.65	36S318	188	54.05
243GUTH	202	650.00	30CWGL	111,115	18.15	36S418	188	58.30
243GUTHS	202	695.00	30CWL	111	12.70	36S434	188	69.25
24CW	109	14.75	30CWLN	111	12.70	36S534	188	75.20
24HP	113	32.85	30GE1	194	17.65	36S638	188	83.55
24LPCW	109	20.20	30GE2	194	15.90	36S738	188	92.90
24LPHP	113	44.80	30HPC	115	14.75	36S800	188	99.75
24PP	117	9.65	30HPCH	115	16.70	36S900	188	110.75
2500 (Group 1)	12	38.05	30HPCHN	115	16.70	36S958	188	116.65
2500 (Group 3)	12	50.25	30HPD	113	11.30	3753 (Group 1)	13	25.30
2500CT	22	59.40	30HPL	115	24.90	3753 (Group 3)	13	33.05
250LCD	146	230.00	30HPLN	115	24.90	3753CL		Discontinued
250LCDCVR	146	130.00	30PPCH	117	5.65	3853 (Group 1)	13	25.10
25CLRCW	110	18.95	30PPCHN	117	7.00	3853 (Group 3)	13	33.05
25CLRHP	114	42.10	30PPD	117	4.40	38CW	109	18.30
25E1	194	17.35	30PPSC	117	6.50	400DIV	161	75.00
25E2	194	15.05	30S1114	187	131.90	400MCCW	120	20.50
25E4	195	20.20	30S318	187	54.05	400STP	153	15.00
25E5	195	16.95	30S434	187	69.25	40CWC	111	6.25
25MCCW	120	6.55	30S638	187	83.55	40CWCH	111	6.25
25S1058	187	123.35	30S800	187	99.75	40CWCHN	111	6.25
25S1114	187	131.90	30S958	187	116.65	40CWD	109	5.55
25S1214	187	141.95	30SC	111,115	4.75	40HPC	115	12.00
25S318	187	51.60	3200P2	40	3.59	40HPCH	115	12.90
25S418	187	55.85	3242 (Group 1)	13	18.05	40HPCHN	115	13.10
25S434	187	68.50	3242 (Group 3)	13	20.80	40HPD	113	11.30
25S534	187	71.85	3253 (Group 1)	13	22.20	40PPCH	117	5.55
25S638	187	81.95	3253 (Group 3)	13	29.70	40PPD	117	3.70
25S738	187	88.65	3253CL	16	16.85	40PPSC	117	5.25
25S800	187	98.00	3253CT	22	38.90	40SC	111,115	4.25
25S900	187	106.50	32CC	40	3.93	415CBP	208	8.00
25S958	187	113.25	32CW	109	8.90	42CW	109	9.00
25SWG	198	83.25	32HP	113	21.15	42HP	113	18.30
2632 (Group 1)	13	14.90	3343 (Group 1)	13	18.75	44CW	109	10.60
2632 (Group 3)	13	19.25	3343 (Group 3)	13	24.95	44HP	113	22.60
26CF	118	57.55	33CLRCW	110	12.25	44PP	117	6.90
26CW	109	18.95	33CLRHP	114	27.40	45CW	31	2.75

Alpha Numerical Listing

Discontinued items effective 1/1/2013

CODE	PAGE	PRICE	CODE	PAGE	PRICE	CODE	PAGE	PRICE
46 (Group 1)	11	4.85	63CLRHP	114	17.25	8HS434	189	53.20
46 (Group 3)	11	6.75	64CW	109	7.40	8HS638	189	64.25
46CW	109	12.25	64HP	113	17.25	8HS800	189	77.70
46HP	113	28.95	64PP	117	5.15	8HS958	189	91.30
46PP	117	8.00	650WS	137	66.00	8RS8	134	158.00
49E1	194	17.65	65CLRCW	110	9.90	8SFSCW	96	19.85
49E2	195	15.90	65CLRHP	114	20.95	8SFSP	97	12.75
49S1114	188	136.95	65CWNR	31	3.25	8SFSP	97	13.50
49S318	188	54.90	66CF	118	29.45	900 (Group 1)	12	11.70
49S434	188	70.95	66CW	109	9.90	900 (Group 3)	12	14.85
49S638	188	85.40	66HP	113	20.95	900CT	22	18.75
49S800	188	99.75	66PP	117	6.75	900CW	33	9.85
49S958	188	118.35	68VS	32	10.80	900P	40	1.97
4FBRTT	126	1,335.00	6F	50	11.65	900P2	40	2.15
4SFSCW	96	13.05	6FBRTT	126	1,590.00	9011CW	33	11.70
4SFSP	97	8.65	6RS6	134	142.00	9013CW	33	11.70
4SFSP	97	9.20	6SFSCW	96	16.90	901CW	33	10.50
500CW	41	1.55	6SFSP	97	10.75	905CW	33	10.80
500LCD	146	265.00	6SFSP	97	11.40	909CW	33	10.75
500LDCVDR	146	130.00	6TGS	54	2.50	90CWC	111	5.50
500P	40	0.97	6UBR		Discontinued	90CWCN	111	5.50
500P2	40	1.04	725CWNR	31	4.45	90CWD	109	2.25
50CW	31	3.25	730SR	137	105.00	90HPC	115	7.20
50MCCW	120	12.20	730STP	133	26.00	90HPD	113	4.30
5412CBP	134,148	9.55	730WS	137	46.00	90PPC	117	4.15
55CWNR	31	2.75	75CW	31	4.25	90PPD	117	1.70
57 (Group 1)	11	5.25	800CW	41	1.90	90PPSC	117	4.15
57 (Group 3)	11	7.35	800P	40	1.17	90SC	111,115	2.90
5FBRTT	126	1,470.00	800P2	40	1.26	90SPCW	31	7.35
5UBR		Discontinued	806CW	33	9.75	9113CP	27	6.80
60CFC	118	6.50	810 (Group 1)	11	11.55	9113CW	27	16.05
60CW	31	3.25	810 (Group 3)	11	14.95	9114CP	27	6.80
60CWC	111	4.90	825CWNR	31	5.20	9114CW	27	16.75
60CWCH	111	5.40	8262MT	18	25.20	911CPC	27	3.70
60CWCHN	111	5.40	826MT	18	16.05	911CWC	27	11.35
60CWD	109	2.95	8302MT	18	33.85	911VS	32	13.15
60CWGL	111,115	14.90	830MT	18	22.15	912CBP	208	10.85
60CWL	111	7.20	850CW	41	4.85	913MT	18	17.15
60CWLN	111	7.20	853FCP	28	5.45	913VS	32	12.75
60HPC	115	10.45	853FCPC	28	2.90	915 (Group 1)	11	16.45
60HPCH	115	10.45	853FCW	28	11.35	915 (Group 3)	11	19.05
60HPCHN	115	10.45	853FCWC	28	6.00	915CP	25	6.55
60HPD	113	5.80	853FH	28	18.05	915CW	25	12.05
60HPL	115	14.25	853FHC	28	10.40	918MT	18	18.60
60HPLN	115	14.25	85SFVS	32	12.75	91VS	32	12.75
60PPCH	117	4.80	86VS	32	11.95	926 (Group 1)	11	21.50
60PPCHN	117	5.25	8F	50	13.55	926 (Group 3)	11	27.80
60PPD	117	2.45	8FB434	192	43.10	92615MT	18	20.65
60PPSC	117	4.80	8FBNH434	192	25.35	926MT	18	20.70
60SC	111,115	3.25	8HC258	190,194	26.20	92CW	109	6.65
62CW	109	6.55	8HC414	190	43.45	92HP	113	10.80
62HP	113	14.30	8HE1	195	13.80	93CW	31	7.30
6302MT	18	30.75	8HE2	195	12.40	94CW	109	8.10
630MT	18	19.60	8HS1114	189	104.70	94HP	113	12.65
63CLRCW	110	7.40	8HS318	189	38.90	94PP	117	5.80

Alpha Numerical Listing

Discontinued items effective 1/1/2013

CODE	PAGE	PRICE	CODE	PAGE	PRICE	CODE	PAGE	PRICE
950CW	41	2.20	BAR730PMT	138	15,485.00	CD2020HB	201	570.00
950P	40	1.36	BAR730PMT220	138	15,600.00	CD2028	202	290.00
950P2	40	1.48	BBR480	126	760.00	CD300	153	305.00
95VS	32	12.75	BBR720	126	905.00	CD300H	153	480.00
96CW	31	4.25	BC1115SH	210	75.00	CD300HB	153	570.00
96SKRC	55	5.70	BC11TC	210	85.00	CD400	153	335.00
96SKRD	55	5.70	BC225	210	560.00	CDR2020	198,201	170.00
96SKRF	55	5.70	BC2254S	210	580.00	CDR2020H	198,201	275.00
96SKRLC	55	0.95	BC230	210	710.00	CFPFRC10	118	37.50
96SKRLD	55	0.95	BC2304S	210	720.00	CFPMRC10	118	37.85
96SKRLF	55	0.95	BC235	210	770.00	CFPSRC10	118	15.90
96SKRLM	55	0.95	BC2354S	210	780.00	CFR18	118	31.95
96SKRLP	55	0.95	BC330	210	765.00	CFRC18	118	17.80
96SKRM	55	5.70	BC3304S	210	775.00	CFRSC18	118	5.30
96SKRP	55	5.70	BC331KD	209	196.00	CHPEL80	177	9,500.00
978SFVS	32	13.00	BC331KDSH	209	46.00	CHPL100	177	9,500.00
99SMVS	32	12.75	BC331KDTC	209	80.00	CJ80CW	55	8.25
99VS	32	12.75	BC340KD	209	292.00	CL900P	37,179	97.75
9CWNR	31	5.00	BC340KDP	209	80.00	CL950P	37,179	71.30
9E1	194	15.50	BCT1014	24	9.95	CLLT10	37,179	89.25
9E2	194	14.60	BR258	191,194	33.70	CLLT12	37,179	97.75
9RS9	134	173.00	BR414	191	49.05	CLLT6	37,179	110.25
9S1114	186	131.90	BR578	178,191	62.90	CLNT10	37,179	89.25
9S318	186	51.60	BR712	191	77.20	CLNT12	37,179	97.75
9S434	186	67.30	BSB10	50	11.95	CLNT20		Discontinued
9S638	186	80.35	BSB12	50	15.40	CLNT5	37,179	110.25
9S800	186	97.70	BSB18	50	32.45	CLNT8	37,179	69.60
9S958	186	113.25	BUF48	126	410.00	CLRSB16	178	260.00
9TGS	54	3.90	BUF72	126	475.00	CLRSB9	178	158.50
ADCS	205	1,285.00	BV6CW	43	3.50	CLRSM8B5	178	119.00
BAR540	141	2,445.00	BWB16CW	35	11.55	CLRWSR36	178	24.90
BAR540DS	141	3,130.00	BWM10CW	35	11.10	CLSB16	179	110.00
BAR54SR	137	72.00	BWP14CW	35	12.05	CLSB9	179	81.90
BAR650	141	4,775.00	BWW10CW	35	8.75	CLSM8B5	179	97.65
BAR650CP	141	7,110.00	CB1220	130,131,133,170	42.00	CLSRB5	42,179	146.45
BAR650DS	141	6,500.00	CC32	119	580.00	CLSSM8B5	179	81.90
BAR650DSCP	141	9,225.00	CCP12	52	9.45	CMB1826		Discontinued
BAR650SDX	140	10,640.00	CCP15	52	14.80	CMB1826L	155	3,185.00
BAR650SPM	140	14,550.00	CCP27	52	15.75	CMB1826LSP	155	3,475.00
BAR650SPMT	140	16,420.00	CCPL12	52	1.35	CMB1826SP		Discontinued
BAR650SPMT2	140	16,530.00	CCPL27	52	1.40	CMBH1826LC	170	6,020.00
BAR650DX	140	8,780.00	CD100	153	305.00	CMBH1826LF	170	6,020.00
BAR650PM	140	13,175.00	CD100H	153	490.00	CMBH1826LTR	170	6,305.00
BAR650PMT	140	14,455.00	CD100HB	153	595.00	CMBH1826TBC	170	9,405.00
BAR650PMT220	140	14,890.00	CD1313	202	255.00	CMBH1826TBF	170	9,405.00
BAR730	139	5,590.00	CD1327	202	275.00	CMBH1826TSC	170	9,405.00
BAR730CP	139	8,065.00	CD1420	153, 202	275.00	CMBH1826TSF	170	9,405.00
BAR730DS	139	7,585.00	CD160	153	305.00	CMBH1826TTR	170	9,925.00
BAR730DSCP	139	11,465.00	CD1826H	153,201	510.00	CMBHC1826LC	170	12,345.00
BAR730SDX	138	12,595.00	CD1826HB	153,201	635.00	CMBHC1826LF	170	12,345.00
BAR730SPM	138	15,995.00	CD1826MTC	153,158	555.00	CMBHC1826LTR	170	12,670.00
BAR730SPMT	138	18,035.00	CD1826MTCHB	153,158	700.00	CMBHC1826TBC	170	17,340.00
BAR730SPMT2	138	18,150.00	CD1826PDB	91	340.00	CMBHC1826TBF	170	17,340.00
BAR730DX	138	9,370.00	CD2020	201	280.00	CMBHC1826TSC	170	17,340.00
BAR730PM	138	14,150.00	CD2020H	201	440.00	CMBHC1826TSF	170	17,340.00

Alpha Numerical Listing

Discontinued items effective 1/1/2013

CODE	PAGE	PRICE
CMBHC1826TTR	170	17,895.00
CMBP	157	5,450.00
CMBPH	167	7,775.00
CMBPH2	167	7,775.00
CMBPH2HD	167	7,915.00
CMBPHD	157	5,590.00
CMBPHDR7	157,167	500.00
CMBPHHD	167	7,915.00
CMBPHSP	167	8,295.00
CMBPHSPHD	167	8,435.00
CMBPR1	157,167	78.00
CMBPSP	157	5,970.00
CMBPSPHD	157	6,110.00
CMBPTH	167	6,675.00
CMBPTH2	167	6,675.00
CMBPTH2HD	167	6,815.00
CMBPTHHD	167	6,815.00
CMBR	170	55.00
CP12	52	8.25
CP1210	130,133,161	67.00
CP1220	130,133,148,161	130.00
CP15	52	10.25
CP27	52	11.70
CP814	130,133,161	67.00
CPB1220	125	185.00
CPH3	125	65.00
CPL12	52	1.40
CPL27	52	1.45
CR12	203	285.00
CRP12910	193	140.80
CRP12911	193	180.05
CRP141012	193	195.80
CRP181112	193	203.45
CRP191011	193	180.05
CRP2046	193	137.45
CRP20910	193	159.90
CRP2878	193	137.45
CRP3067	193	137.45
CRP4467	193	148.50
CRP4856	193	137.45
CRP6345	193	137.45
CRP9911	193	180.05
CRPG12910	195	20.35
CRPG12911	195	24.65
CRPG141012	195	25.50
CRPG181112	195	28.70
CRPG191011	195	26.85
CRPG2046	195	35.05
CRPG20910	195	28.35
CRPG2878	195	24.35
CRPG3067	195	29.70
CRPG4467	195	34.30
CRPG4856	195	35.05
CRPG6345	195	35.05
CRPG9911	195	24.65

CODE	PAGE	PRICE
CRPH1656	193	109.25
CRPHDG2878	178,191,195	25.85
CRPHG1656	195	28.05
CS1424SK	64	65.20
CS1424VK	64	63.60
CS1430SK	64	80.95
CS1430VK	64	79.05
CS1436SK	64	89.95
CS1436VK	64	87.60
CS1442SK	64	103.60
CS1442VK	64	100.30
CS1448SK	64	114.20
CS1448VK	64	111.10
CS1454SK	64	127.75
CS1454VK	64	123.65
CS1460SK	64	137.80
CS1460VK	64	132.65
CS1472SK	64	161.65
CS1472VK	64	155.80
CS1824SK	64	68.45
CS1824VK	64	65.25
CS1830SK	64	84.20
CS1830VK	64	80.70
CS1836SK	64	93.60
CS1836VK	64	89.40
CS1842SK	64	112.05
CS1842VK	64	106.70
CS1848SK	64	118.10
CS1848VK	64	112.95
CS1854SK	64	136.60
CS1854VK	64	130.15
CS1860SK	64	149.60
CS1860VK	64	141.95
CS1872SK	64	173.55
CS1872VK	64	165.00
CS2124SK	64	76.10
CS2124VK	64	73.10
CS2130SK	64	95.25
CS2130VK	64	90.60
CS2136SK	64	106.45
CS2136VK	64	100.95
CS2142SK	64	126.50
CS2142VK	64	120.65
CS2148SK	64	136.10
CS2148VK	64	128.10
CS2154SK	64	156.05
CS2154VK	64	147.70
CS2160SK	64	169.90
CS2160VK	64	161.15
CS2172SK	64	199.15
CS2172VK	64	187.95
CS2424SK	64	81.00
CS2424VK	64	74.80
CS2430SK	64	100.05
CS2430VK	64	93.10

CODE	PAGE	PRICE
CS2436SK	64	112.35
CS2436VK	64	104.75
CS2442SK	64	130.05
CS2442VK	64	122.25
CS2448SK	64	142.50
CS2448VK	64	133.85
CS2454SK	64	160.45
CS2454VK	64	150.20
CS2460SK	64	173.95
CS2460VK	64	162.30
CS2472SK	64	203.95
CS2472VK	64	191.15
CSA41366	66	514.65
CSA41367	66	516.90
CSA41426	66	593.45
CSA41427	66	595.70
CSA41486	66	623.25
CSA41487	66	625.50
CSA41546	66	701.65
CSA41547	66	703.90
CSA41606	66	755.45
CSA41607	66	757.70
CSA44366	67	530.65
CSA44367	67	533.15
CSA44426	67	600.65
CSA44427	67	603.15
CSA44486	67	647.05
CSA44487	67	649.55
CSA44546	67	712.45
CSA44547	67	714.95
CSA44606	67	760.85
CSA44607	67	763.35
CSA48366	65	465.65
CSA48367	65	468.05
CSA48426	65	534.85
CSA48427	65	537.25
CSA48486	65	559.85
CSA48487	65	562.25
CSA48546	65	628.65
CSA48547	65	631.05
CSA48606	65	675.85
CSA48607	65	678.25
CSA51366	66	615.60
CSA51367	66	617.85
CSA51426	66	714.10
CSA51427	66	716.35
CSA51486	66	751.35
CSA51487	66	753.60
CSA51546	66	849.35
CSA51547	66	851.60
CSA51606	66	916.60
CSA51607	66	918.85
CSA54366	67	635.40
CSA54367	67	637.90
CSA54368PKG	68	655.00

Alpha Numerical Listing

Discontinued items effective 1/1/2013

CODE	PAGE	PRICE	CODE	PAGE	PRICE	CODE	PAGE	PRICE
CSA54426	67	722.90	CSFT722	71	50.10	CSU41606	66	866.30
CSA54427	67	725.40	CSHDC	73	42.00	CSU41607	66	870.80
CSA54428PKG	68	742.50	CSHDDB	73,88	10.70	CSU44366	67	642.30
CSA54486	67	780.90	CSHDTK10	73	620.00	CSU44367	67	647.30
CSA54487	67	783.40	CSHDTK12	73	715.00	CSU44426	67	712.30
CSA54488PKG	68	800.50	CSHDTK145	73	805.00	CSU44427	67	717.30
CSA54546	67	862.65	CSID	63,81	2.25	CSU44486	67	758.70
CSA54547	67	865.15	CSID3	63,81	2.25	CSU44487	67	763.70
CSA54548PKG	68	882.25	CSPDC5	180	758.00	CSU44546	67	824.10
CSA54606	67	923.15	CSPK1432	63	69.25	CSU44547	67	829.10
CSA54607	67	925.65	CSPK1456	63	94.60	CSU44606	67	872.50
CSA54608PKG	68	942.75	CSPK1464	63	103.20	CSU44607	67	877.50
CSA58366	65	555.05	CSPK1472	63	105.65	CSU48366	65	573.70
CSA58367	65	557.45	CSPK1484	63	122.70	CSU48367	65	578.50
CSA58426	65	641.55	CSPK1832	63	74.10	CSU48426	65	642.90
CSA58427	65	643.95	CSPK1856	63	99.45	CSU48427	65	647.70
CSA58486	65	672.80	CSPK1864	63	108.05	CSU48486	65	667.90
CSA58487	65	675.20	CSPK1872	63	110.45	CSU48487	65	672.70
CSA58546	65	758.80	CSPK1884	63	127.65	CSU48546	65	736.70
CSA58547	65	761.20	CSPK2132	63	76.90	CSU48547	65	741.50
CSA58606	65	817.80	CSPK2156	63	102.30	CSU48606	65	783.90
CSA58607	65	820.20	CSPK2164	63	110.85	CSU48607	65	788.70
CSCC	63	5.40	CSPK2172	63	113.10	CSU51366	66	726.45
CSCR	69	40.25	CSPK2184	63	130.25	CSU51367	66	730.95
CSCS	69	40.25	CSPK2432	63	77.75	CSU51426	66	824.95
CSCSL	69	56.00	CSPK2456	63	103.10	CSU51427	66	829.45
CSCTL	69	68.00	CSPK2464	63	111.65	CSU51486	66	862.20
CSDBA	74	5.50	CSPK2472	63	114.15	CSU51487	66	866.70
CSDBS	74	5.50	CSPK2484	63	131.25	CSU51546	66	960.20
CSDC	180	136.00	CSPRK1835	69	76.60	CSU51547	66	964.70
CSDDCPKG480	180	2,166.40	CSPRK1859	69	103.40	CSU51606	66	1,027.45
CSDS14	63	69.05	CSPRK1867	69	112.40	CSU51607	66	1,031.95
CSDS18	63	71.30	CSPRK1875	69	114.80	CSU54366	67	747.05
CSDS21	63	73.10	CSPRK2135	69	79.30	CSU54367	67	752.05
CSDS24	63	74.95	CSPRK2159	69	106.15	CSU54368PKG	68	786.25
CSEQ3	63,81	33.00	CSPRK2167	69	115.05	CSU54426	67	834.55
CSFE14	71	19.75	CSPRK2175	69	117.50	CSU54427	67	839.55
CSFE18	71	21.35	CSPRK2435	69	80.25	CSU54428PKG	68	873.75
CSFE21	71	22.55	CSPRK2459	69	107.00	CSU54486	67	892.55
CSFE24	71	23.80	CSPRK2467	69	115.90	CSU54487	67	897.55
CSFT241	71	19.80	CSPRK2475	69	118.40	CSU54488PKG	68	931.75
CSFT242	71	26.10	CSR3	146	465.00	CSU54546	67	974.30
CSFT301	71	21.10	CSR5	146	485.00	CSU54547	67	979.30
CSFT302	71	28.70	CSRDB	69	9.30	CSU54548PKG	68	1,013.50
CSFT361	71	22.40	CSSB	69	45.40	CSU54606	67	1,034.80
CSFT362	71	31.35	CSSC2448	74	640.00	CSU54607	67	1,039.80
CSFT421	71	23.80	CSTSR	74	287.00	CSU54608PKG	68	1,074.00
CSFT422	71	34.95	CSU41366	66	625.50	CSU58366	65	663.10
CSFT481	71	25.85	CSU41367	66	630.00	CSU58367	65	667.90
CSFT482	71	37.65	CSU41426	66	704.30	CSU58426	65	749.60
CSFT541	71	27.90	CSU41427	66	708.80	CSU58427	65	754.40
CSFT542	71	41.20	CSU41486	66	734.10	CSU58486	65	780.85
CSFT601	71	29.20	CSU41487	66	738.60	CSU58487	65	785.65
CSFT602	71	43.80	CSU41546	66	812.50	CSU58546	65	866.85
CSFT721	71	32.60	CSU41547	66	817.00	CSU58547	65	871.65

Alpha Numerical Listing

Discontinued items effective 1/1/2013

CODE	PAGE	PRICE	CODE	PAGE	PRICE	CODE	PAGE	PRICE
CSU58606	65	925.85	CSURS44427	71	897.10	DCC10	46	10.65
CSU58607	65	930.65	CSURS44486	71	938.30	DCC5	46	7.65
CSUHD44367	73	815.30	CSURS44487	71	943.50	DCS1125	207	1,055.00
CSUHD44367S	73	845.70	CSURS48366	70	753.70	DCS950	207	1,010.00
CSUHD44427	73	885.30	CSURS48367	70	758.50	DD1220BECW	51	79.65
CSUHD44427S	73	916.50	CSURS48426	70	822.90	DD1220CW	51	51.75
CSUHD44486	73	926.70	CSURS48427	70	827.70	DD1220ECW	51	65.40
CSUHD44486S	73	961.30	CSURS48486	70	847.90	DD1220SCW	51	65.40
CSUHD44487	73	931.70	CSURS48487	70	852.70	DD1826CW	51	72.60
CSUHD44487S	73	966.30	CSURS51366	70	906.15	DG3CW	35	2.35
CSUR41366	70	881.90	CSURS51367	70	911.05	DIV12	125,133,150,153	4.00
CSUR41367	70	886.80	CSURS51426	70	1,004.65	DIV20	125	9.55
CSUR41426	70	960.70	CSURS51427	70	1,009.55	DP15	46	12.85
CSUR41427	70	965.60	CSURS51486	70	1,041.90	DRC2020	178	55.55
CSUR41486	70	990.50	CSURS51487	70	1,046.80	DRLNK	89	2.40
CSUR41487	70	995.40	CSURS54366	71	926.65	DRS30	89	220.00
CSUR44366	71	898.80	CSURS54367	71	931.85	DRS300	89	220.00
CSUR44367	71	903.80	CSURS54426	71	1,014.15	DRS36	89	240.00
CSUR44426	71	968.80	CSURS54427	71	1,019.35	DRS360	89	240.00
CSUR44427	71	973.80	CSURS54486	71	1,072.15	DRS48	89	290.00
CSUR44486	71	1,015.20	CSURS54487	71	1,077.35	DRS480	89	290.00
CSUR44487	71	1,020.20	CSURS58366	70	843.10	DRS60	89	330.00
CSUR48366	70	830.40	CSURS58367	70	847.90	DRS600	89	330.00
CSUR48367	70	835.20	CSURS58426	70	929.60	DSPR6	42	45.35
CSUR48426	70	899.60	CSURS58427	70	934.40	DT1220CW	51	20.85
CSUR48427	70	904.40	CSURS58486	70	960.85	E3	178,195	12.45
CSUR48486	70	924.60	CSURS58487	70	965.65	EA183664	85	358.10
CSUR48487	70	929.40	CSWF	63,81	25.00	EA183672	85	359.95
CSUR51366	70	982.85	CSWS1436SK	75	145.15	EA184264	85	411.70
CSUR51367	70	987.75	CSWS1436VK	75	145.15	EA184272	85	413.55
CSUR51426	70	1,081.35	CSWS1448SK	75	166.65	EA184864	85	431.10
CSUR51427	70	1,086.25	CSWS1448VK	75	166.65	EA184872	85	432.95
CSUR51486	70	1,118.60	CSWS1836SK	75	166.65	EA185464	85	484.30
CSUR51487	70	1,123.50	CSWS1848SK	75	182.75	EA185472	85	486.15
CSUR54366	71	1,003.55	CSWS36EK	75	205.00	EA186064	85	520.90
CSUR54367	71	1,008.55	CSWS48EK	75	305.00	EA186072	85	522.75
CSUR54426	71	1,091.05	CVC55	132	3,495.00	EA213664	85	396.20
CSUR54427	71	1,096.05	CVC72	132	5,830.00	EA213672	85	397.95
CSUR54486	71	1,149.05	CVC724	132	5,830.00	EA214264	85	456.80
CSUR54487	71	1,154.05	D12	39	1.49	EA214272	85	458.55
CSUR58366	70	919.80	D14	39	1.84	EA214864	85	480.00
CSUR58367	70	924.60	D16	39	1.89	EA214872	85	481.75
CSUR58426	70	1,006.30	D24	39	2.45	EA215464	85	540.80
CSUR58427	70	1,011.10	D8	39	1.41	EA215472	85	542.55
CSUR58486	70	1,037.55	DB18263CW	91	49.25	EA216064	85	582.40
CSUR58487	70	1,042.35	DB18263P	91	39.40	EA216072	85	584.15
CSURS41366	70	805.20	DB18266CW	91	66.20	EA243664	85	408.45
CSURS41367	70	810.10	DBC1826CW	91	35.90	EA243672	85	410.30
CSURS41426	70	884.00	DBC1826P	91	26.50	EA243684PKG	85	423.20
CSURS41427	70	888.90	DC10	46	15.00	EA244264	85	462.65
CSURS41486	70	913.80	DC1225	207	1,075.00	EA244272	85	464.50
CSURS41487	70	918.70	DC5	46	10.90	EA244284PKG	85	477.40
CSURS44366	71	821.90	DC575	207	1,010.00	EA244864	85	498.25
CSURS44367	71	827.10	DC700	207	1,010.00	EA244872	85	500.10
CSURS44426	71	891.90	DC825	207	1,010.00	EA244884PKG	85	513.00

Alpha Numerical Listing

Discontinued items effective 1/1/2013

CODE	PAGE	PRICE	CODE	PAGE	PRICE	CODE	PAGE	PRICE
EA245464	85	549.05	EMU183678	87	659.30	ESK1448V	83	86.00
EA245472	85	550.90	EMU183678P	87	675.30	ESK1454S	82	98.90
EA245484PKG	85	563.80	EMU184270	87	709.20	ESK1454V	83	95.75
EA246064	85	586.65	EMU184270P	87	725.20	ESK1460S	82	106.65
EA246072	85	588.50	EMU184278	87	712.90	ESK1460V	83	102.70
EA246084PKG	85	601.40	EMU184278P	87	728.90	ESK1472S	82	125.15
ECC	81	5.80	EMU184870	87	728.60	ESK1472V	83	120.55
EDBA	88	4.40	EMU184870P	87	744.60	ESK1478S	82	134.35
EDBS	88	4.40	EMU184878	87	732.30	ESK1478V	83	129.50
EDS14	81	49.50	EMU184878P	87	748.30	ESK1830S	82	61.95
EDS18	81	51.10	EMU213670	87	695.50	ESK1830V	83	59.35
EDS21	81	52.45	EMU213670P	87	711.50	ESK1836S	82	72.45
EDS24	81	53.70	EMU213678	87	699.00	ESK1836V	83	69.20
EMPK1870	86	84.40	EMU213678P	87	715.00	ESK1836V4	83	276.80
EMPK1878	86	86.25	EMU214270	87	756.30	ESK1842S	82	86.75
EMPK2170	86	86.45	EMU214270P	87	772.30	ESK1842V	83	82.60
EMPK2178	86	88.20	EMU214278	87	759.80	ESK1848S	82	91.35
EMPK2470	86	87.15	EMU214278P	87	775.80	ESK1848V	83	87.45
EMPK2478	86	89.00	EMU214870	87	779.50	ESK1848V4	83	349.80
EMSC	88	45.00	EMU214870P	87	795.50	ESK1854S	82	105.75
EMSCB	88	47.00	EMU214878	87	783.00	ESK1854V	83	100.75
EMSCBP	88	55.00	EMU214878P	87	799.00	ESK1860S	82	115.80
EMSCP	88	45.00	EMU243670	87	708.70	ESK1860V	83	109.90
EMSK1836S	86	78.95	EMU243670P	87	724.70	ESK1860V4	83	439.60
EMSK1836V	86	75.70	EMU243678	87	712.40	ESK1872S	82	134.35
EMSK1842S	86	93.20	EMU243678P	87	728.40	ESK1872V	83	127.75
EMSK1842V	86	89.10	EMU244270	87	762.90	ESK1878S	82	143.70
EMSK1848S	86	97.85	EMU244270P	87	778.90	ESK1878V	83	136.75
EMSK1848V	86	93.95	EMU244278	87	766.60	ESK2130S	82	70.40
EMSK1854S	86	112.20	EMU244278P	87	782.60	ESK2130V	83	66.75
EMSK1854V	86	107.20	EMU244870	87	798.50	ESK2136S	82	82.45
EMSK1860S	86	122.30	EMU244870P	87	814.50	ESK2136V	83	78.20
EMSK1860V	86	116.40	EMU244878	87	802.20	ESK2142S	82	97.90
EMSK2136S	86	88.95	EMU244878P	87	818.20	ESK2142V	83	93.35
EMSK2136V	86	84.65	EPK1464	81	77.70	ESK2148S	82	105.35
EMSK2142S	86	104.40	EPK1472	81	79.45	ESK2148V	83	99.15
EMSK2142V	86	99.85	EPK1484	81	92.35	ESK2154S	82	120.80
EMSK2148S	86	111.85	EPK1864	81	81.30	ESK2154V	83	114.35
EMSK2148V	86	105.65	EPK1872	81	83.15	ESK2160S	82	131.55
EMSK2154S	86	127.30	EPK1884	81	96.10	ESK2160V	83	124.75
EMSK2154V	86	120.80	EPK2164	81	83.40	ESK2172S	82	154.15
EMSK2160S	86	138.00	EPK2172	81	85.15	ESK2172V	83	145.50
EMSK2160V	86	131.20	EPK2184	81	98.05	ESK2178S	82	165.40
EMSK2436S	86	93.40	EPK2464	81	84.05	ESK2178V	83	155.90
EMSK2436V	86	87.60	EPK2472	81	85.90	ESK2430S	82	75.10
EMSK2442S	86	107.15	EPK2484	81	98.80	ESK2430V	83	71.15
EMSK2442V	86	101.15	ES28	131	1,255.00	ESK2436S	82	86.95
EMSK2448S	86	116.80	ES28RL	131	1,675.00	ESK2436V	83	81.10
EMSK2448V	86	110.05	ESK1430S	82	60.25	ESK2436V4	83	324.40
EMSK2454S	86	130.70	ESK1430V	83	59.05	ESK2442S	82	100.70
EMSK2454V	86	122.70	ESK1436S	82	69.65	ESK2442V	83	94.65
EMSK2460S	86	141.15	ESK1436V	83	67.85	ESK2448S	82	110.30
EMSK2460V	86	132.15	ESK1442S	82	80.20	ESK2448V	83	103.55
EMU183670	87	655.60	ESK1442V	83	77.65	ESK2448V4	83	414.20
EMU183670P	87	671.60	ESK1448S	82	88.45	ESK2454S	82	124.20

Alpha Numerical Listing

Discontinued items effective 1/1/2013

CODE	PAGE	PRICE
ESK2454V	83	116.25
ESK2460S	82	134.65
ESK2460V	83	125.65
ESK2460V4	83	502.60
ESK2472S	82	157.85
ESK2472V	83	147.95
ESK2478S	82	169.50
ESK2478V	83	159.20
ESU183664	84	439.40
ESU183672	84	443.10
ESU184264	84	493.00
ESU184272	84	496.70
ESU184864	84	512.40
ESU184872	84	516.10
ESU185464	84	565.60
ESU185472	84	569.30
ESU186064	84	602.20
ESU186072	84	605.90
ESU213664	84	479.60
ESU213672	84	483.10
ESU214264	84	540.20
ESU214272	84	543.70
ESU214864	84	563.40
ESU214872	84	566.90
ESU215464	84	624.20
ESU215472	84	627.70
ESU216064	84	665.80
ESU216072	84	669.30
ESU243664	84	492.50
ESU243672	84	496.20
ESU243684PKG	84	522.00
ESU244264	84	546.70
ESU244272	84	550.40
ESU244284PKG	84	576.20
ESU244864	84	582.30
ESU244872	84	586.00
ESU244884PKG	84	611.80
ESU245464	84	633.10
ESU245472	84	636.80
ESU245484PKG	84	662.60
ESU246064	84	670.70
ESU246072	84	674.40
ESU246084PKG	84	700.20
FBR5R		Discontinued
FBR6R		Discontinued
FBRTBL		Discontinued
FR258	192	36.30
FSG480	126	360.00
FSG720	126	460.00
FWC56	192	4.40
FWC56	203	4.40
GB1200CW	35	4.90
GB850CW	35	4.15
GK2000	190	17.40
HBR258	191,194	22.85

CODE	PAGE	PRICE
HBR414	191	36.75
HBR578	191	47.35
HBR712	191	58.30
HE3	195	11.05
HFR258	192	31.30
HK39	31	29.60
HK39B	175	10.65
HK93BCW	31	15.70
HK93CW	31	28.95
HT10CW	38	2.81
HT120CW	38	2.94
HT12CW	38	2.88
HT14CW	38	3.23
HT16CW	38	3.76
HT22CW	38	4.70
HT5CW	38	2.58
HT8CW	38	2.70
HWAPR	147	250.00
HWATD	147	330.00
HYDRASTATIONPKG	147	1,116.00
IB32	119	390.00
IB36	119	400.00
IB44	119	405.00
IBS20	119	365.00
IBS27	119	375.00
IBS37	119	400.00
IBSF27	119	390.00
ICS100L	142	965.00
ICS100L4S	142	990.00
ICS125L	142	985.00
ICS125LB	142	1,060.00
ICS125T	142	1,050.00
ICS175L	142	1,175.00
ICS175LB	142	1,220.00
ICS175T	142	1,230.00
ICS175TB	142	1,315.00
ICS200TB	142	1,345.00
KK1200	190	16.35
KMC24	130	715.00
KSC402	131	5,170.00
KSC402220	131	5,170.00
KVC854	130	7,115.00
KVC854C	130	9,705.00
KVC854U	130	7,585.00
KVC856	130	7,115.00
KVC856C	130	9,705.00
KVC856U	130	7,585.00
KWS40	131	2,480.00
LCDCH	147	85.00
LCDCH10	147	125.00
LCDES	147	17.05
LD105	52	3.30
LD105A	52	4.75
LD130	52	3.70
LD130A		Discontinued

CODE	PAGE	PRICE
LD85	52	3.30
LD85A	52	4.75
LED54LIGHTPKG	125	480.00
LT10	39	2.08
LT12	39	2.28
LT14	39	2.41
LT16	39	2.67
LT22	39	3.00
LT6	39	1.84
LT8	39	2.01
MDC1411T60	183	5,735.00
MDC1418S20	181	3,545.00
MDC1418T16	182	3,245.00
MDC1418T30	182	5,735.00
MDC1520S20	181	3,610.00
MDC1520T16	182	3,330.00
MDC1520T30	182	5,790.00
MDC24	148	2,390.00
MDC24F	148	2,390.00
MDC24R	148	140.00
MDSB16	178	5.85
MDSB5	178	3.00
MDSB9	178	3.00
MDSCDB9	175	95.00
MDSCDCB9	176	8,500.00
MDSCDCCPKG480	180	560.00
MDS9	175	18.55
MDSDCPKG480	180	3,100.00
MDSL9	175	8.40
MDSL9	175	14.00
MDSM8	178	3.00
MDSP9	175	43.35
MDSPL	180	81.90
MDSPLT9	175	189.00
NT10	38	1.81
NT12	38	1.88
NT14	38	2.18
NT16	38	2.25
NT20	38	2.78
NT5	38	1.47
NT8	38	1.52
NT9	38	1.66
OETR314	192	35.55
P320CW	34	10.70
P34CW	34	\$8.50
P480CW	34	12.90
P600CW	34	13.65
P60CW	34	15.75
P64CW	34	15.75
PC64CW	34	20.25
PE600CW	34	9.35
PL60CW	34	9.35
PPB15	43	74.40
PPB18	43	98.15
PPB23	43	168.85

Alpha Numerical Listing

Discontinued items effective 1/1/2013

CODE	PAGE	PRICE	CODE	PAGE	PRICE	CODE	PAGE	PRICE
PR314	192	36.30	RFSC6PP	101	2.35	SPO8CW	53	2.60
PR500	178,192	51.60	RFSCW1	100	6.65	SPOP10CW	53	2.85
PR59314	192	36.30	RFSCW12	100	32.55	SPOP11		Discontinued
PR59500	192	51.60	RFSCW18	100	44.65	SPOP11CW	53	3.50
PS1014	24	6.20	RFSCW2	100	9.20	SPOP13	53	8.65
PSB10	48	11.95	RFSCW22	100	51.40	SPOP13CW	53	6.00
PSB12	48	15.45	RFSCW4	100	15.55	SRB13	42	3.40
PSB15	49	25.15	RFSCW6	100	18.20	SRB13CW	42	4.45
PSB18	49	40.05	RFSCW8	100	23.05	SRB5	42	1.85
PSB23	49	61.00	RFSCWC1	100	2.40	SRB5CW	42	2.25
PSB6	48	3.55	RFSCWC12	100	12.45	TC1418	203	1,130.00
PSB8	48	6.05	RFSCWC2	100	4.30	TDC2029	203	1,005.00
PT1014	23	13.15	RFSCWC6	100	5.45	TDC30	207	1,320.00
PT1100	23	10.25	RSB1014CW	49	18.50	TDCR12	203	1,325.00
PT1216	23	14.35	RSB10CW	49	16.20	TG6	54	2.45
PT1400	23	13.70	RSB12CW	49	27.00	TG9	54	3.90
PT1418	23	18.15	RSB1419CW	49	30.00	TGA11	54	4.50
PT1600	23	18.50	RSB15CW	49	34.90	TGA8	54	3.85
PWB22	42	26.50	RSB18CW	49	50.25	TGG6	54	3.85
PWB22	147	26.50	RSB23CW	49	75.70	TGG9	54	4.15
R1000LCD	147	100.00	RSB6CW	49	4.55	UC1000	146	410.00
R500LCD	147	90.00	RSB8CW	49	8.85	UC1000CVR	146	130.00
RD1200CW	51	29.95	RSB912CW	49	12.65	UC250	146	270.00
RD1220CW	51	54.75	SB55	50	1.85	UC250CVR	146	130.00
RD1220CWH	51	77.90	SB60	50	2.20	UC500	146	305.00
RD1826CW	51	70.95	SB80	50	4.45	UC500CVR	146	130.00
RD1826CWH	51	82.80	SBH15	125	65.00	UPC100	150	425.00
RD926CW	51	48.20	SBH18	125	65.00	UPC101	150	425.00
RFS1	101	4.15	SCP12CW	120	7.25	UPC1200	155	1,825.00
RFS12	101	14.90	SCP24CW	120	9.20	UPC140	150	375.00
RFS12PP	101	15.85	SCP64CW	120	13.10	UPC160	150	380.00
RFS12SCPP	100	7.00	SCP6CW	120	6.70	UPC1600	155	2,635.00
RFS18	101	18.10	SFC12	97	6.25	UPC1600HD	155	2,775.00
RFS18PP	101	19.25	SFC12SCPP	96	6.25	UPC1600TR	155	2,675.00
RFS1PP	101	4.30	SFC2	97	3.45	UPC180	150	390.00
RFS1SCPP	100	2.05	SFC2SCPP	96	3.45	UPC400	152	565.00
RFS2	101	4.45	SFC6	97	4.30	UPC400TR	152	590.00
RFS22	101	21.30	SFC6SCPP	96	4.30	UPC600	155	1,190.00
RFS22PP	101	22.60	SFG1012	47	16.75	UPC800	155	1,405.00
RFS2PP	101	4.75	SFG1015	47	17.85	UPC800TR	155	1,415.00
RFS2SCPP	100	3.15	SFG1220	47	22.80	UPCH1600	164	5,455.00
RFS4	101	5.10	SFG820	47	19.00	UPCH16002	164	5,455.00
RFS4PP	101	5.55	SFR1012	47	16.75	UPCH16002HD	164	5,610.00
RFS6	101	6.35	SFT1010	47	15.85	UPCH1600HD	164	5,610.00
RFS6PP	101	6.70	SFT1212	47	17.15	UPCH400	164	1,330.00
RFS6SCPP	100	3.25	SFT1515	47	19.90	UPCH4002	164	1,330.00
RFS8	101	8.30	SFV1015	47	17.45	UPCH800	164	3,205.00
RFS8PP	101	8.90	SLL30	106	180.25	UPCH8002	164	3,205.00
RFSC1	101	1.40	SPA14	53	9.70	UPCHT1600	164	4,245.00
RFSC12	42,101	4.95	SPASL14	53	9.70	UPCHT16002	164	4,245.00
RFSC12PP	101	5.45	SPO10CW	53	2.85	UPCHT16002HD	164	4,400.00
RFSC1PP	101	1.60	SPO11		Discontinued	UPCHT1600HD	164	4,400.00
RFSC2	101	1.45	SPO11CW	53	3.50	UPCHT800	164	2,440.00
RFSC2PP	101	1.65	SPO13	53	8.65	UPCHT8002	164	2,440.00
RFSC6	101	2.05	SPO13CW	53	6.00	UPCHW400	164	1,525.00

Alpha Numerical Listing

Discontinued items effective 1/1/2013

CODE	PAGE	PRICE	CODE	PAGE	PRICE
UPCHW4002	164	1,525.00	WCS30	43	92.15
UPCS140	150	260.00	WW1000CW	41	10.45
UPCS160	150	270.00	WW1000L	41	0.95
UPCS180	150	290.00	WW1000LS	41	0.95
UPCS400	152	515.00	WW1500CW	41	13.60
UPCS400CK	153	135.00	WW250CW	41	4.65
UPCSS160	150	270.00	WW250L	41	0.95
UTHSTP	153	17.00	WW500CW	41	7.70
VBR5	124	2,850.00			
VBR6	124	2,970.00			
VBRC	124	170.00			
VBRC90	124	285.00			
VBRCVR5	125	310.00			
VBRCVR6	125	340.00			
VBRHD5	124	3,080.00			
VBRHD6	124	3,200.00			
VBRL5	124	2,850.00			
VBRL6	124	2,970.00			
VBRLHD5	124	3,080.00			
VBRLHD6	124	3,200.00			
VBRR5	125	402.00			
VBRR6	125	424.00			
VBRSHTS	125	265.00			
VBRT5	124	2,110.00			
VBRT6	124	2,235.00			
VBRTBL	125	430.00			
VBRTCVR5	125	165.00			
VBRTCVR6	125	180.00			
VBRTHD5	124	2,340.00			
VBRTHD6	124	2,465.00			
VBRTL5	124	2,015.00			
VBRTL6	124	2,140.00			
VBRTLHD5	124	2,245.00			
VBRTLHD6	124	2,370.00			
VBRU5	124	3,640.00			
VBRU6	124	3,885.00			
VBRUHD5	124	3,870.00			
VBRUHD6	124	4,115.00			
VBRUT5	124	2,460.00			
VBRUT6	124	2,570.00			
VBRUTHD5	124	2,690.00			
VBRUTHD6	124	2,800.00			
VBRWC	125	126.00			
VCS	124	2,255.00			
VCS32CNT	124	295.00			
VCS32KEYT	125	59.00			
VCS32R	125	330.00			
VCSCNL	124	355.00			
VCSCVR	125	165.00			
VCSHD	124	2,485.00			
VCSWR	124	2,320.00			
VCSWRHD	124	2,550.00			
WC100CW	43	40.95			
WC100CWNH	43	23.55			
WCR1220	130,133	99.00			

Cambro Equipment Color Chart



Gray (180)



Coffee Beige (157)



Hot Red (158)

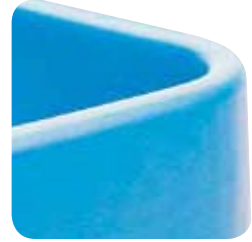

Cold Blue (159)



Speckled Gray (480)



Dark Taupe (417)



Brick Red (402)



Navy Blue (186)



Sandstone (614)



Granite Sand (194)

Cambro provides a wide selection of colors to help you coordinate with your decor and color code items to simplify use. Color selections vary by product. Please see individual products for specific colors offered.



Slate Blue (401)



Granite Gray (191)



Dark Brown (131)

Due to the catalog printing process, the colors shown may not be exact. For exact colors, contact Cambro or a Cambro representative for a color chip.



Granite Green (192)



Charcoal Gray (615)



Bronze (146)



Kentucky Green (519)



Black (110)



CAMBRO U.S.A.
5801 Skylab Road, Huntington Beach, CA 92647 P.O. Box 2000, Huntington Beach, CA 92647-2000
Telephone: (714) 848-1555 Toll Free: (800) 854-7631 FAX: (714) 842-3430
Customer Service: (800) 833-3003
© 2013 Cambro Manufacturing Company. Printed in the U.S.A.
CAT2013US All prices are in US dollars. All prices are subject to change without prior notice.



Cambro is a proud recipient of the U.S. President's E-Award™ for Excellence in Exporting.

New from CAMBRO®



Treadlite™ Trays
Page 23



1 Liter Pitcher
Page 34



Yellow Food Storage Box
Page 103



Versa Food Service System *Ultra Series*
Page 123



Hydration Station
Page 147



Combo Cart™ *Plus*
Non-Electric
Page 156



Combo Cart™ *Plus*
Electric
Page 165



Shoreline Collection
Wheat and Meadow
Page 174



Low Profile Insulatd Dome
and Entree Bowl
Page 175, 178